

Typical Applications

- Wireless Meter Reading
- Keyless Entry Systems
- 433/868/915MHz ISM Bands Systems
- Remote Data Transfers
- Wireless Security Systems

Product Description

The RF2919 is a monolithic integrated circuit intended for use as a low cost ASK/OOK receiver. The device is provided in 32-lead plastic packaging and is designed to provide a fully functional AM receiver. The chip is intended for applications in the North American 915MHz ISM band and European 433MHz and 868MHz ISM bands. The integrated VCO, +64 prescaler, and reference oscillator require only the addition of an external crystal to provide a complete phase-locked oscillator for single channel applications. A data comparator is included to provide logic level outputs.

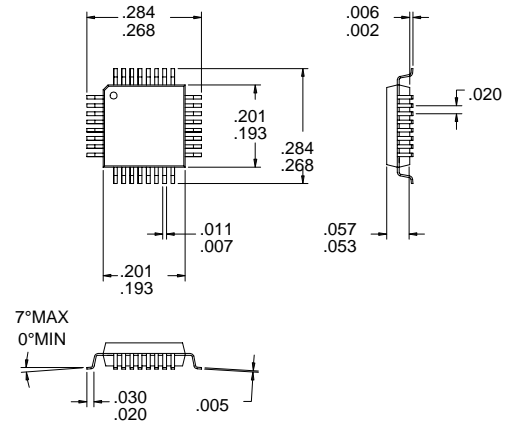

Package Style: LQFP-32

Optimum Technology Matching® Applied

- Si BJT GaAs HBT GaAs MESFET
 Si Bi-CMOS SiGe HBT Si CMOS

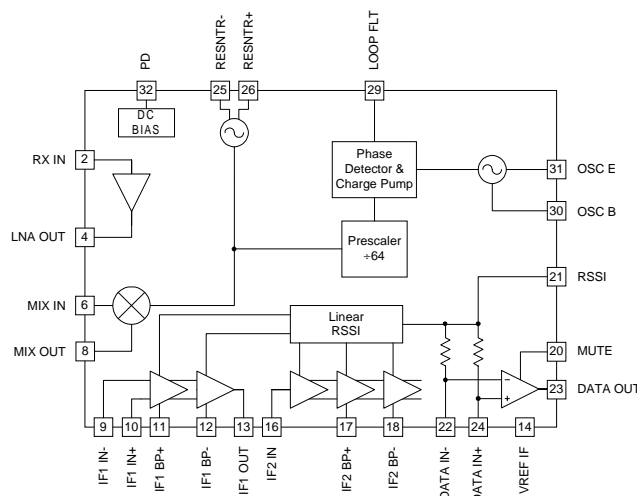

Functional Block Diagram

Features

- Fully Monolithic Integrated Receiver
- 2.7V to 5.0V Supply Voltage
- Up to 256kbps Data Rates
- 300MHz to 1000MHz Frequency Range
- Power Down Capability
- Analog or Digital Output

Ordering Information

- RF2919 433/868/915MHz ASK/OOK Receiver
 RF2919 PCBA-L Fully Assembled Evaluation Board, 433MHz
 RF2919 PCBA-M Fully Assembled Evaluation Board, 868MHz
 RF2919 PCBA-H Fully Assembled Evaluation Board, 915MHz

RF Micro Devices, Inc.
7625 Thorndike Road
Greensboro, NC 27409, USA

Tel (336) 664 1233
Fax (336) 664 0454
<http://www.rfmd.com>

RF2919

Absolute Maximum Ratings

| Parameter | Ratings | Unit |
|-------------------------------|--------------|-----------------|
| Supply Voltage | -0.5 to +5.5 | V _{DC} |
| Control Voltages | -0.5 to +5.0 | V _{DC} |
| Input RF Level | +10 | dBm |
| Output Load VSWR | 50:1 | |
| Operating Ambient Temperature | -40 to +85 | °C |
| Storage Temperature | -40 to +150 | °C |



Caution! ESD sensitive device.

RF Micro Devices believes the furnished information is correct and accurate at the time of this printing. However, RF Micro Devices reserves the right to make changes to its products without notice. RF Micro Devices does not assume responsibility for the use of the described product(s).

| Parameter | Specification | | | Unit | Condition |
|---|---------------|---|------|--|---|
| | Min. | Typ. | Max. | | |
| Overall RF Frequency Range | | 300 to 1000 | | MHz | T=25 °C, V _{CC} =3.6V, Freq=915MHz |
| VCO and PLL Section VCO Frequency Range PLL Lock Time PLL Phase Noise Reference Frequency Crystal R _S Charge Pump Current | | 300 to 1000 10 -74 -98 0.5 50 40 | | MHz ms dBc/Hz dBc/Hz MHz Ω μA | The PLL lock time is set externally by the bandwidth of the loop filter and start-up of the crystal. 915MHz, 5kHz loop BW, 10kHz offset 915 MHz, 5kHz loop BW, 100kHz offset Sink and source current |
| Overall Receive Section Frequency Range RX Sensitivity LO Leakage RSSI DC Output Range RSSI Sensitivity RSSI Dynamic Range | | 300 to 1000 -104 0.4 to 1.5 13 60 | | MHz dBm dBm V mV/dB dB | IF BW=150kHz, Freq=915MHz, S/N=8dB R _L =24kΩ MUTE = 0 MUTE = 0 |
| LNA Power Gain Noise Figure Input IP ₃ Input P _{1dB} RX IN Impedance Output Impedance | | 18 16 3.6 3.7 -8 -15 82-j86 77-j43 Open Collector | | dB dB dB dBm dBm Ω Ω Ω | 433MHz, Matched to 50Ω 915MHz, Matched to 50Ω 433MHz 915MHz 915 MHz 915 MHz 433MHz (see Plots) 915MHz (see Plots) |
| Mixer Conversion Power Gain Noise Figure (SSB) Input IP ₃ Input IP ₃ Input P _{1dB} Input P _{1dB} | | 15 7.5 17 17 -20 -15 -30 -26 | | dB dB dB dB dBm dBm dBm dBm | Single-ended configuration 433MHz, Matched to 50Ω 915MHz, Matched to 50Ω 433MHz, SSB Measurement 915MHz, SSB Measurement 433MHz 915MHz 433MHz 915MHz |
| First IF Section IF Frequency Range Voltage Gain Noise Figure IF1 Input Impedance IF1 Output Impedance | | 10.7 34 13 330 330 | | MHz dB dB Ω Ω | IF = 10.7MHz, Z _L =330Ω |

11

TRANSCEIVERS

| Parameter | Specification | | | Unit | Condition |
|----------------------------|---------------|-------------------|----------------------|------------------|--|
| | Min. | Typ. | Max. | | |
| Second IF Section | | | | | |
| IF Frequency Range | 0.1 | 10.7 | 25 | MHz | IF=10.7MHz, internal to demod |
| Voltage Gain | | 60 | | dB | |
| Noise Figure | | 13 | | dB | |
| Input IP ₃ | | | | mV _{PP} | |
| IF2 Input Impedance | | 330 | | Ω | |
| Data Output Impedance | | 6.3 - j25.7 | | kΩ | |
| Data Output Rise/Fall Time | | 150 | | ns | |
| Data Output Level | 0.3 | | V _{CC} -0.3 | V | Z _{LOAD} =1MΩ 3pF Z _{LOAD} =1MΩ 3pF |
| Power Down Control | | | | | |
| Logical Controls "ON" | 2.0 | | | V | Voltage supplied to the input |
| Logical Controls "OFF" | | | 1.0 | V | Voltage supplied to the input |
| Control Input Impedance | 25 | | | kΩ | f _{XTAL} = 14.318MHz. Dependent on configuration. |
| Turn On Time | | 4 | | ms | |
| Turn Off Time | | 4 | | ms | |
| Power Supply | | | | | |
| Voltage | | 3.6 2.7 to 5.0 | | V V | Specifications Operating limits |
| Current Consumption | 8 | 10 | 12 1 | mA μA | RX Mode Power Down Mode |

RF2919

| Pin | Function | Description | Interface Schematic |
|-----|----------|--|---------------------|
| 1 | VCC1 | This pin is used to supply DC bias to the receiver RF circuits. An RF bypass capacitor should be connected directly to this pin and returned to ground. A 100pF capacitor is recommended for 915MHz applications. A 220pF capacitor is recommended for 433MHz applications. | |
| 2 | RX IN | RF input pin for the receiver electronics. RX IN input impedance is a low impedance when enabled. RX IN is a high impedance when the receiver is disabled. | |
| 3 | GND1 | Ground connection for RF receiver functions. Keep traces physically short and connect immediately to ground plane for best performance. | |
| 4 | LNA OUT | Output pin for the receiver RF low noise amplifier. This pin is an open collector output and requires an external pull up coil to provide bias and tune the LNA output. | |
| 5 | GND2 | GND2 is connection for the 40 dB IF limiting amplifier. Keep traces physically short and connect immediately to ground plane for best performance. | |
| 6 | MIX IN | RF input to the RF Mixer. An LC matching network between LNA OUT and MIX IN can be used to connect the LNA output to the RF mixer input in applications where an image filter is not needed or desired. | |
| 7 | GND3 | GND3 is the ground connection for the receiver RF mixer. | |
| 8 | MIX OUT | IF output from the RF mixer. Interfaces directly to 10.7MHz ceramic IF filters as shown in the application schematic. A pull-up inductor and series matching capacitor should be used to present a 330Ω termination impedance to the ceramic filter. Alternately, an IF tank can be used to tailor the IF frequency and bandwidth to meet the needs of a given application. In addition to the matching components, a 15pF capacitor should be placed from this pin to ground. | |
| 9 | IF1 IN- | Balanced IF input to the 40dB limiting amplifier strip. A DC blocking capacitor is required on this input, 10nF is recommended. | |
| 10 | IF1 IN+ | Functionally the same as pin 9 except non-inverting node amplifier input. In single-ended applications, this input should be bypassed directly to ground through a 10 nF capacitor. | See pin 9. |
| 11 | IF1 BP+ | DC feedback node for the 40dB limiting amplifier strip. A 10nF bypass capacitor from this pin to ground is recommended. | See pin 9. |
| 12 | IF1 BP- | See pin 11. | See pin 9. |
| 13 | IF1 OUT | IF output from the 40dB limiting amplifier. The IF1 OUT output presents a nominal 330Ω output resistance and interfaces directly to 10.7MHz ceramic filters. | |
| 14 | VREF IF | DC voltage reference for the IF limiting amplifiers (typically 1.1 V). A 10nF capacitor from this pin to ground is recommended. | |
| 15 | GND5 | Ground connection for 60dB IF limiting amplifier. Keep traces physically short and connect immediately to ground plane for best performance. | |

| Pin | Function | Description | Interface Schematic |
|-----|----------|---|---------------------|
| 16 | IF2 IN | Inverting input to the 60dB limiting amplifier strip. A 10 nF DC blocking capacitor is required on this input. The IF2 IN input presents a nominal 330Ω input resistance and interfaces directly to 10.7MHz ceramic filters. | |
| 17 | IF2 BP+ | DC feedback node for the 60dB limiting amplifier strip. A 10nF bypass capacitor from this pin to ground is required. | See pin 16. |
| 18 | IF2 BP- | See pin 17. | See pin 16. |
| 19 | VCC3 | This pin is used to supply DC bias to the 60dB IF limiting amplifier. An IF bypass capacitor should be connected directly to this pin and returned to ground. A 10 nF capacitor is recommended for 10.7MHz IF applications. | |
| 20 | MUTE | This pin is used to mute the data output (DATA OUT). MUTE > 2.0V turns the DATA OUT signal on. MUTE < 1.0V turns the DATA OUT signal off. | |
| 21 | RSSI | A DC voltage proportional to the received signal strength is output from this pin. The output voltage increases with increasing signal strength. | |
| 22 | DATA IN- | The inverting input of the data comparator. The RSSI is fed to this pin via a 50kΩ resistor. This input is available for a data filtering capacitor that provides noise and 2x IF rejection. The value of the capacitor can be calculated by $C = 1/(2\pi F * 50k\Omega)$ where F is the desired 3dB bandwidth. | |
| 23 | DATA OUT | The data comparator output which contains the modulating data recovered from the RSSI signal. Hysteresis can be added to the comparator by placing a very large (< 1 MΩ) resistor between pins 23 and 24. The magnitude of the load impedance is intended to be 1 MΩ or greater. | |
| 24 | DATA IN+ | The non-inverting input of the data comparator. The RSSI is fed to this pin via a 50kΩ resistor. This input is available for a large filtering capacitor such that the modulation signal can be filtered out leaving a DC reference signal for the comparator. | See pin 22. |
| 25 | RESNTR- | This port is used to supply DC voltage to the VCO as well as to tune the center frequency of the VCO. Equal value inductors should be connected to this pin and pin 26. | |
| 26 | RESNTR+ | See pin 25. | See pin 25. |
| 27 | VCC2 | This pin is used to supply DC bias to the VCO, prescaler, and PLL. An IF bypass capacitor should be connected directly to this pin and returned to ground. A 10 nF capacitor is recommended for 10.7MHz IF applications. | |
| 28 | GND4 | GND4 is the ground shared on chip by the VCO, prescaler, and PLL electronics. | |

RF2919

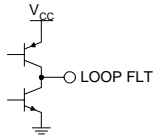
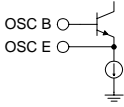
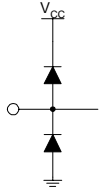
| Pin | Function | Description | Interface Schematic |
|-----|----------|--|---|
| 29 | LOOP FLT | Output of the charge pump, and input to the VCO control. An RC network from this pin to ground is used to establish the PLL bandwidth. |  |
| 30 | OSC B | This pin is connected directly to the reference oscillator transistor base. The intended reference oscillator configuration is a modified Colpitts. A 100pF capacitor should be connected between pin 30 and pin 31. |  |
| 31 | OSC E | This pin is connected directly to the emitter of the reference oscillator transistor. A 100pF capacitor should be connected from this pin to ground. | See pin 30. |
| 32 | PD | This pin is used to power up or down the RF2919. A logic high (PWR DWN >2.0 V) powers up the receiver and PLL. A logic low (PWR DWN <1.0 V) powers down circuit to standby mode. | |
| | ESD | This diode structure is used to provide electrostatic discharge protection to 3kV using the Human body model. The following pins are protected: 1, 3, 5, 7-19, 21-24, 27-31. |  |

RF2919 Theory of Operation and Application Information

The RF2919 is a part of a family of low-power RF transceiver IC's that was developed for wireless data communication devices operating in the European 433MHz/868MHz ISM bands or U.S. 915MHz ISM band. This IC has been implemented in a 15GHz silicon bipolar process technology that allows low-power transceiver operation in a variety of commercial wireless products. The RF2919 realizes a highly integrated, single-conversion ASK/OOK receiver with the addition of a reference crystal, intermediate frequency (IF) filtering, and a few passive components. The LNA (low-noise amplifier) input of the RF2919 is easily matched to a front-end filter or antenna by means of a DC blocking capacitor and reactive components. The receiver local oscillator (LO) is generated by an internalized VCO, PLL and phase discriminator in conjunction with the external reference crystal, loop filter and VCO resonator components. The receiver IF section is optimized to interface with low cost 10.7MHz ceramic filters, and its -3dB bandwidth of 25MHz also allows it to be used (with lower gain) at higher frequencies with other types of filters.

OPERATION

The ASK/OOK demodulation is accomplished by an on-chip data comparator. The RSSI output is internally routed through 50k Ω resistors to provide the inputs (DATA IN+ and DATA IN-) to the data comparator. Either input may be used as the data input with the other input used as the reference. A shunt capacitor can be added to the data input to provide filtering of noise and the second IF harmonic. The value of the data filtering capacitor is calculated by

$$= \frac{1}{2\pi F \cdot 16.7k\Omega}$$

where F is the desired 3dB bandwidth. The factor of 16.7k Ω is the net internal impedance (50k Ω in parallel with a 25k Ω comparator input impedance).

A large filtering capacitor may be used on the reference input to remove the modulation signal, leaving a DC reference for the comparator. Because this reference filter may have a long time constant, a longer preamble may be required to allow the DC reference to stabilize. The data pattern also affects the stability of the DC reference and the reliability of the received data. Since a string of consecutive data 'ones' (or 'zeroes') will result in a change to the DC reference, a coding scheme such as Manchester should be used to

improve data integrity. Hysteresis can be added by placing a resistor between the input and the output.

The DATA OUT pin is only capable of driving rail-to-rail output into a very high impedance and small capacitance, with the amount of capacitance affecting the DATA OUT bandwidth. For a 3pF load, the bandwidth is in excess of 500kHz. The rise and fall times of the RSSI are limited by the bandwidth of the IF filters, thereby limiting the effective data rate.

The RSSI output signal is supplied from a current source and therefore requires a resistor to convert it to a voltage. For a 24k Ω resistive load, the RSSI will typically range from 0.4V to 1.5V (3.6V supply). A small parallel capacitor is suggested to limit the bandwidth and filter noise.

APPLICATION AND LAYOUT CONSIDERATIONS

The RX IN pin is DC biased, requiring a DC blocking capacitor. If the RF filter has DC blocking characteristics, such as a ceramic dielectric filter, then a DC blocking capacitor is not necessary. When in power down mode, the RX IN impedance increases. Therefore in a half-duplex application, the RF2919 RX IN may share the RF filter with a transmitter output having a similar high impedance power down characteristic. Care must be taken in this case to account for loading effects of the transmitter on the receiver and vice versa in matching the filter to both the transmitter and receiver.

The VCO is a very sensitive block in this system. RF signals feeding back into the VCO by either radiation or coupling of traces may cause the PLL to become unlocked. The trace(s) for the anode of the tuning varactor should also be kept short. The layout of the resonators and varactor are very important. The capacitor and varactor should be closest to the RF2919 pins and the trace length should be as short as possible. The inductors can be placed further away and any trace inductance can be compensated by reducing the value of the inductors. Printed inductors may also be used with careful design. For best results, the physical layout should be as symmetrical as possible.

When using loop bandwidths lower than the 5kHz shown on the evaluation board, better supply filtering at the resonators (and lower V_{CC} noise as well) will help reduce phase noise of the VCO; a series resistor of 100 Ω to 200 Ω and a 1 μ F or larger capacitor can be used. Phase noise is generally more critical in narrow-band applications where adjacent channel selectivity is

a concern, but it can also contribute to raising the noise floor of the receiver, thereby degrading sensitivity.

For the interface between the LNA and mixer, the coupling capacitor should be as close to the RF2919 pins as possible with the bias inductor being further away. Once again, the value of the inductor can be changed to compensate for trace inductance. The output impedance of the LNA is on the order of several kΩ which makes matching to 50Ω difficult. If image filtering is desired, a high impedance filter is recommended. If no filtering is used, the match to the mixer input need not be a good conjugate match due to the high gain of the IF amplifier stages. In fact, a conjugate match between the LNA and mixer will not significantly improve sensitivity, but will have an adverse effect on system IIP3 and increase the likelihood of IF instability.

Predicting and Minimizing PLL Lock Time

The RF2919 implements a conventional PLL on chip. The VCO is followed by a prescaler, which divides down the output frequency for comparison with the reference oscillator frequency. The output of the phase discriminator is a sequence of pulse width modulated current pulses in the required direction to steer the VCO's control voltage to maintain phase lock, with a loop filter integrating the current pulses. The lock time of this PLL is a combination of the loop transient response time and the slew rate set by the phase discriminator output current combined with the magnitude of the loop filter capacitance. A good approximation for total lock time of the RF2919 is:

$$LockTime = \frac{D}{F_C} + 35000 \cdot C \cdot dV$$

where D is a factor to account for the loop damping, F_C is the loop cut frequency, C is the sum of all shunt capacitors in the loop filter, and dV is the required step voltage change to produce the desired frequency change during the transient. For loops with low phase margin (30° to 40°), use D=2 whereas for loops with better phase margin (50° to 60°), use D=1.

To lock faster, C needs to be minimized.

1. Design the loop filter for the minimum phase margin possible without causing loop instability problems; this allows C to be kept at a minimum.
2. Design the loop filter for the highest loop cut frequency possible without distorting low frequency modulation components; this also allows C to be kept at a minimum.

For additional applications information, refer to the following technical articles.

TA0031 "Frequency Synthesis Using the RF2510"

DK1000 "ASK Transmit and Receive Chip Set"

Pin Out

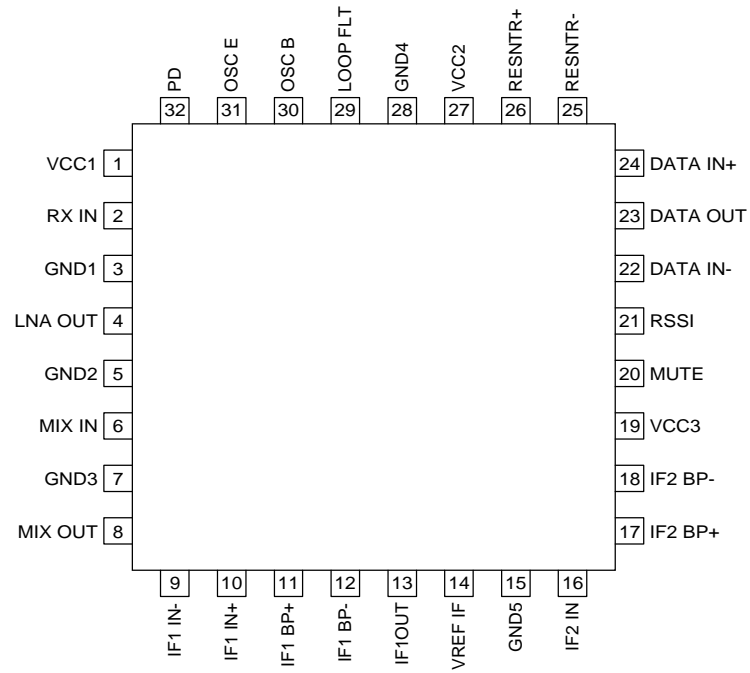

Application Schematic 433MHz

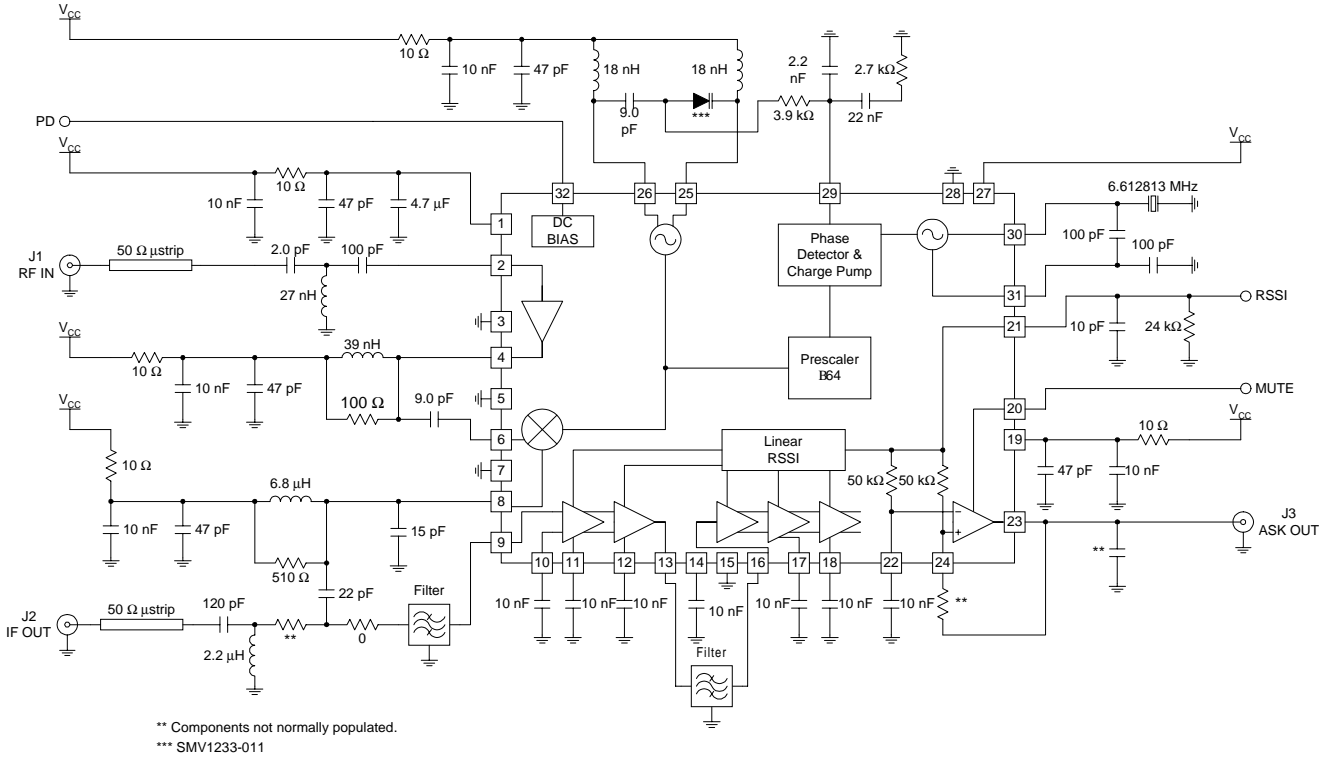

Evaluation Board Schematic H (915MHz), M (868MHz), L (433MHz) Boards (Download [Bill of Materials](http://www.rfmd.com) from www.rfmd.com.)

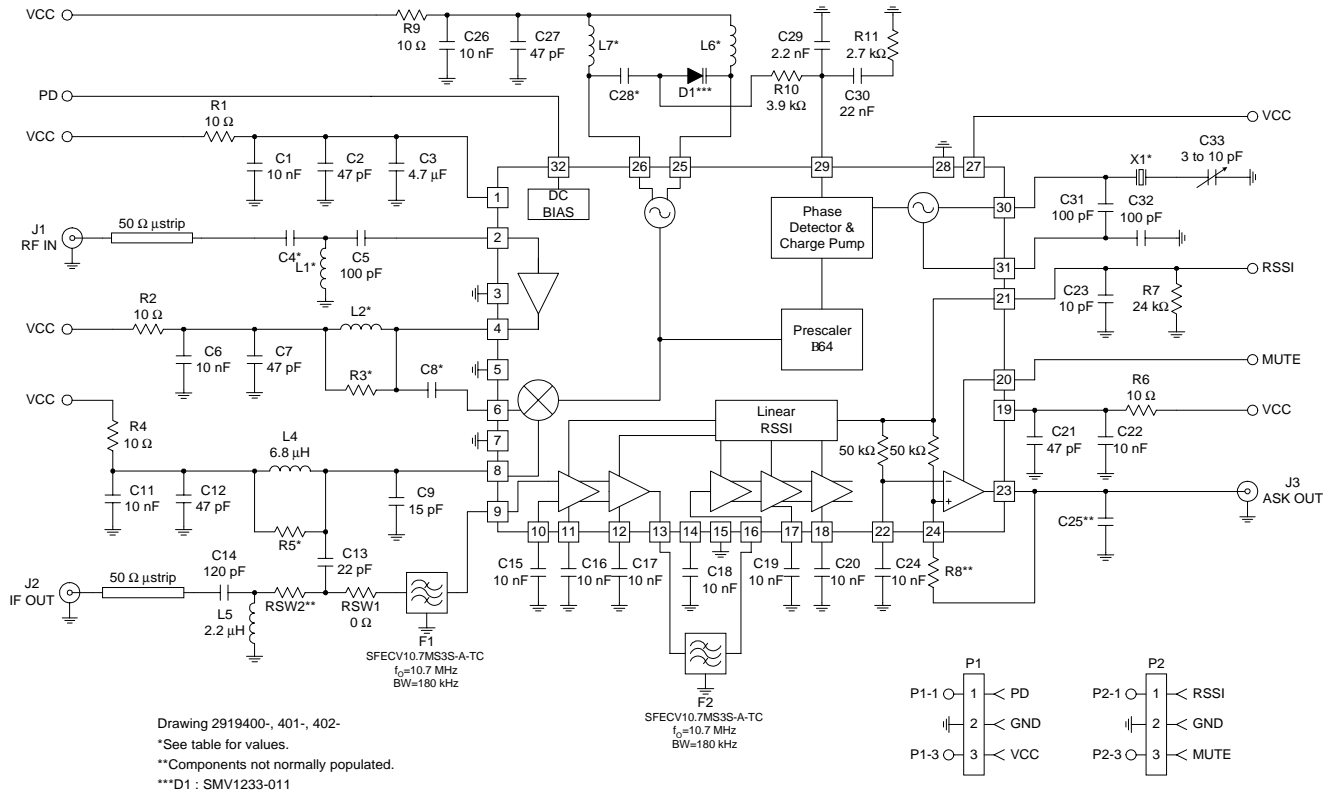

| Board | C4 (pF) | L1 (nH) | L2 (nH) | C8 (pF) | L6 (nH) | L7 (nH) | C28 (pF) | X1 (MHz) | R3 (Ω) | R5 (Ω) |
|------------|---------|---------|---------|---------|---------|---------|----------|----------|--------|--------|
| L (433MHz) | 2.0 | 27 | 39 | 9.0 | 18 | 18 | 9.0 | 6.612813 | 100 | 510 |
| M (868MHz) | 1.5 | 8.2 | 12 | 1.0 | 6.8 | 6.8 | 3.0 | 13.41015 | ** | 1.8 k |
| H (915MHz) | 2.0 | 6.8 | 12 | 1.0 | 6.8 | 6.8 | 3.0 | 14.15099 | ** | 1.8 k |

Evaluation Board Layout - 433MHz Board Size 2.0" x 2.0" Board Thickness 0.040", Board Material FR-4, Multi-Layer

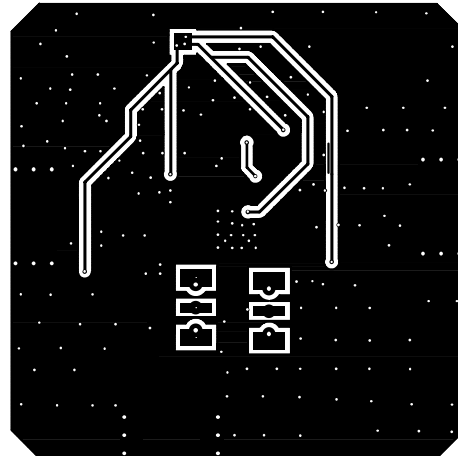
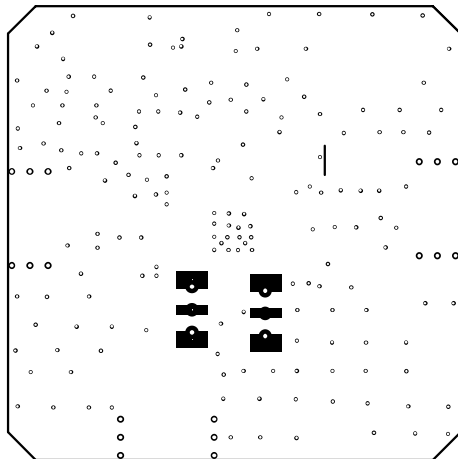
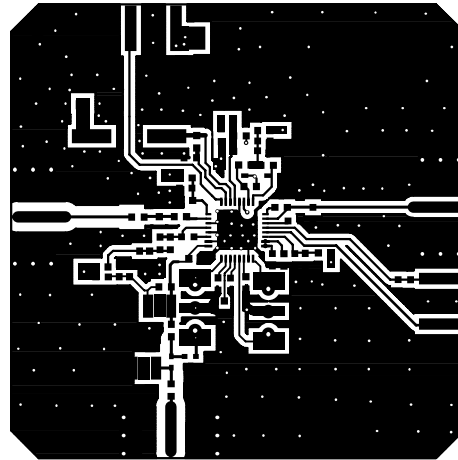
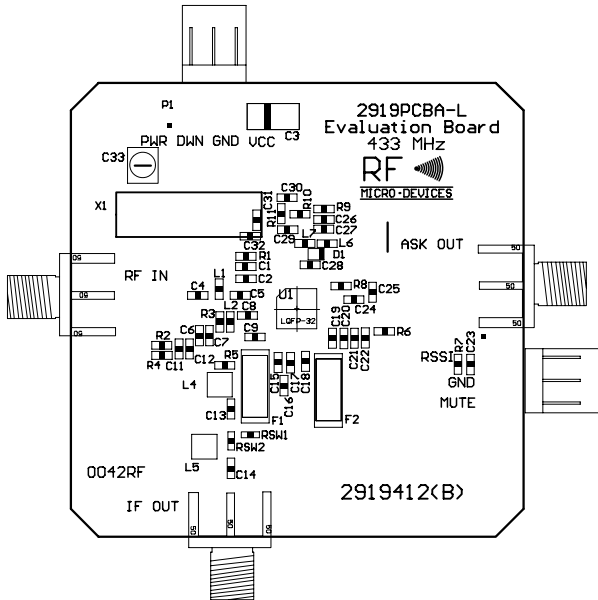

Evaluation Board Layout - 868MHz

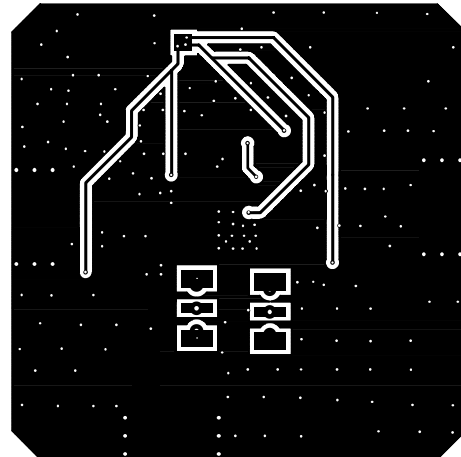
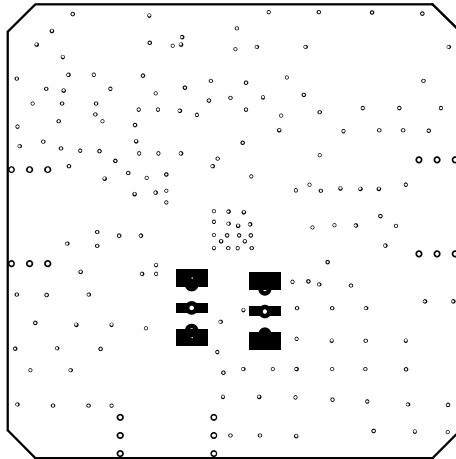
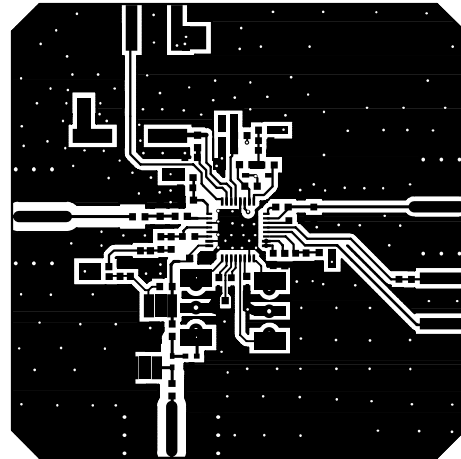
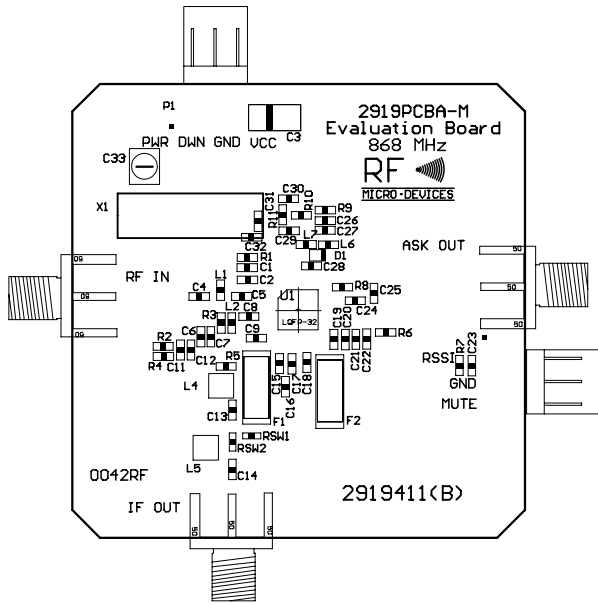

Evaluation Board Layout - 915MHz

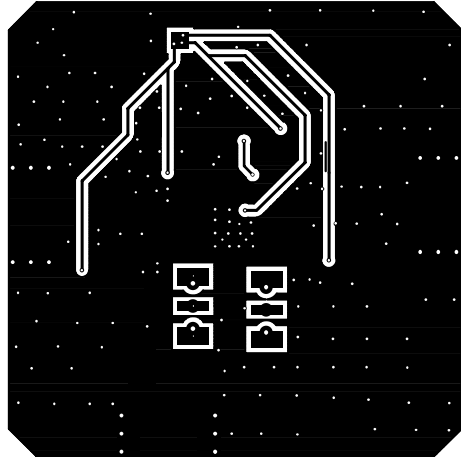
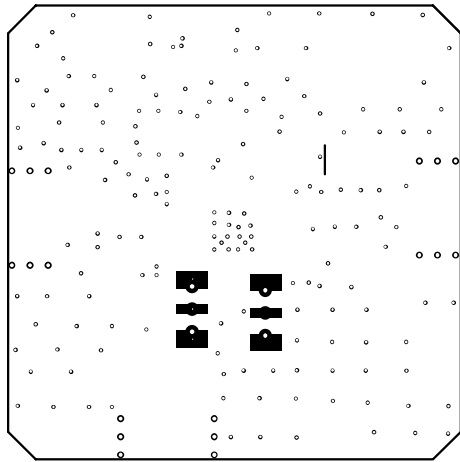
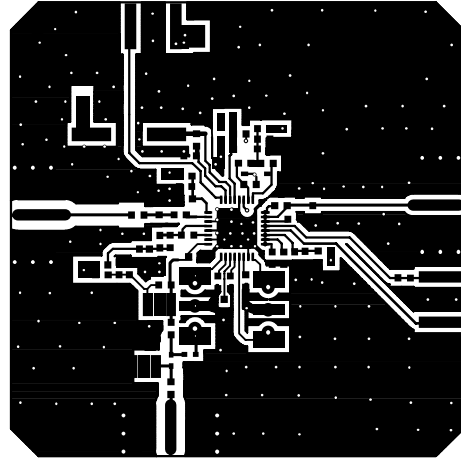
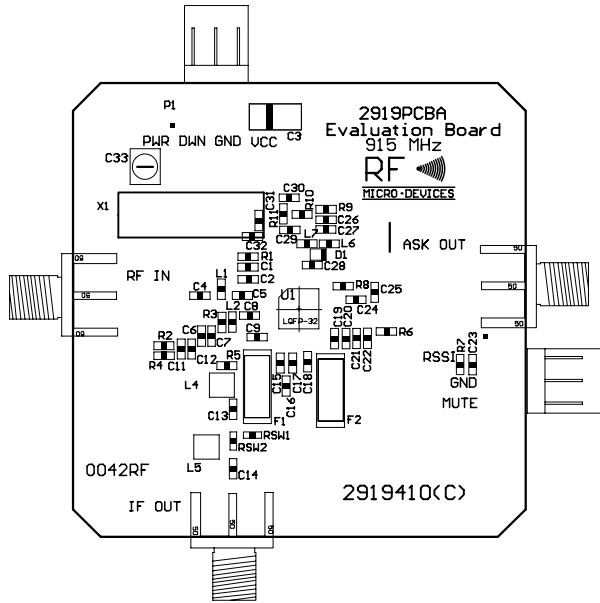

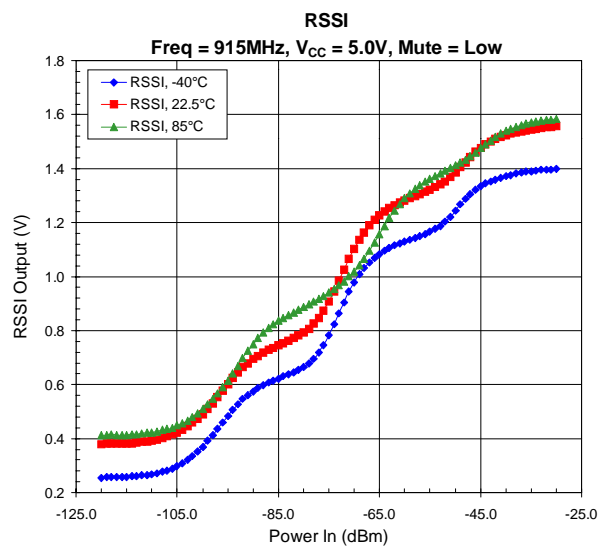
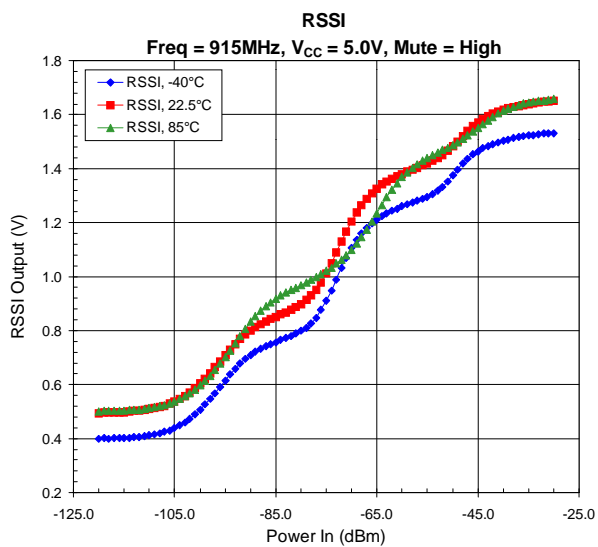
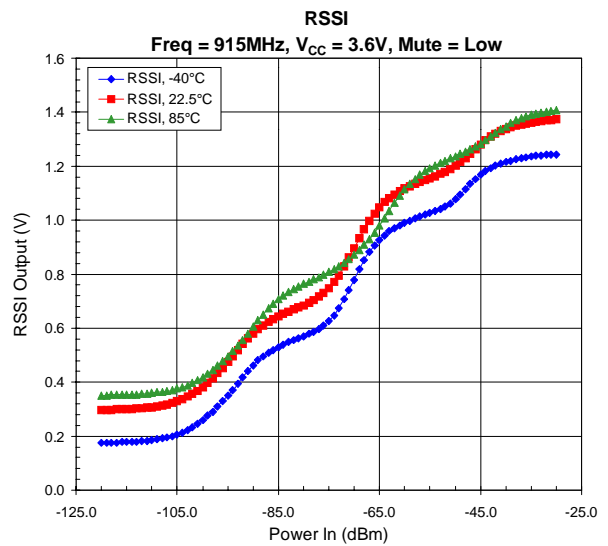
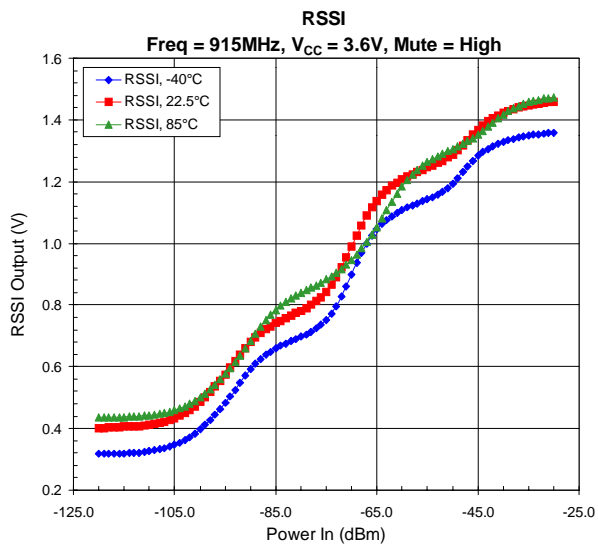
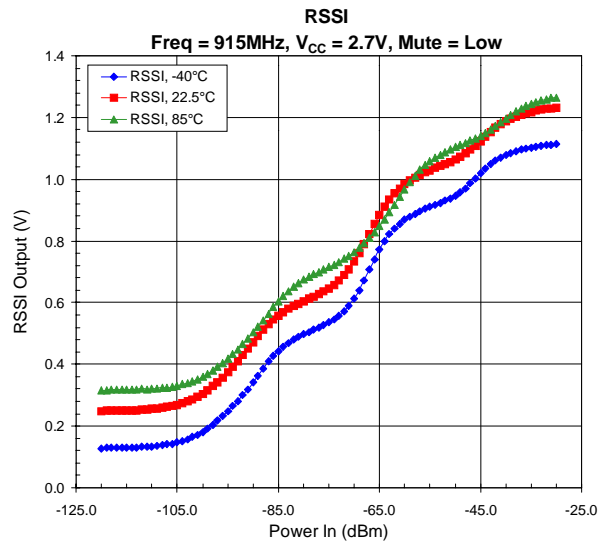
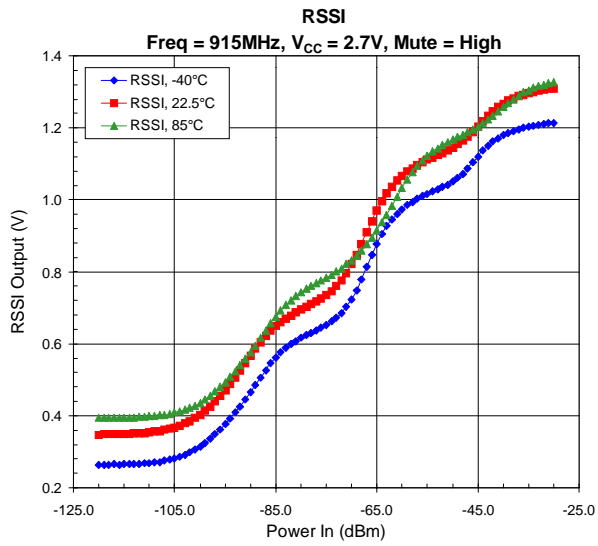

RF2919

Current versus Temperature
RX Frequency = 915MHz

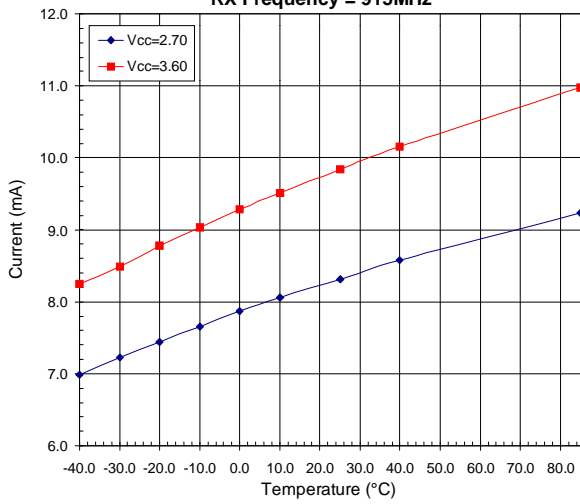

Sensitivity versus Temperature
RX Frequency = 915MHz

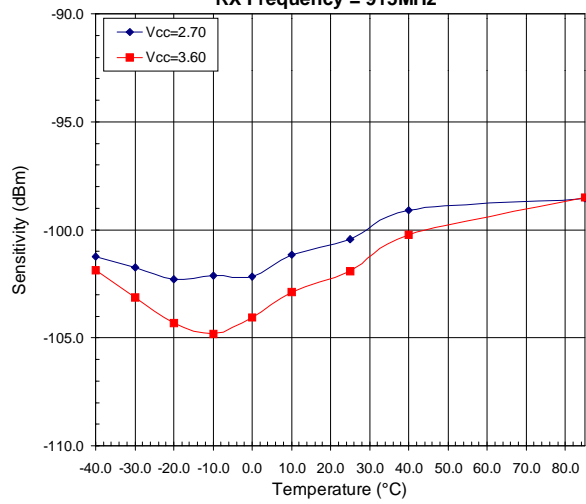

Data Output Level versus Temperature
RX Frequency = 915MHz

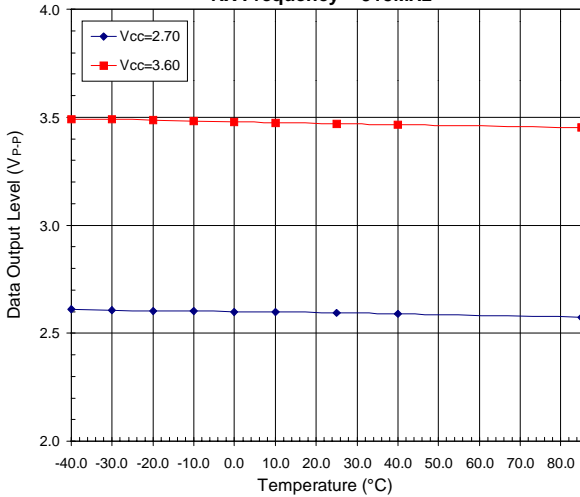

LNA Impedance

