

DESCRIPTION

The RH07 is a precision op amp which provides very low offset voltage, low drift and low noise. In the design, processing and testing of the device, particular attention has been paid to the optimization of the entire distribution of several key parameters. The wafer lots are processed to LTC's in-house Class S flow to yield circuits usable in stringent military applications.

For complete electrical specifications, performance curves, application notes and applications circuits, see the OP-07 data sheet.

ABSOLUTE MAXIMUM RATINGS

Supply Voltage	$\pm 22\text{V}$
Differential Input Voltage	$\pm 30\text{V}$
Input Voltage	$\pm 22\text{V}$
Output Short-Circuit Duration (Note 3)	Indefinite
Operating Temperature Range	-55°C to 125°C
Storage Temperature Range	-65°C to 150°C
Lead Temperature (Soldering, 10 sec)	300°C

BURN-IN CIRCUIT

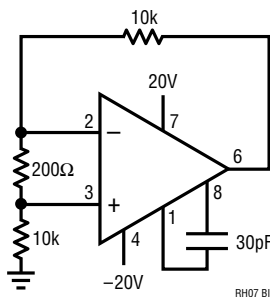

PACKAGE INFORMATION

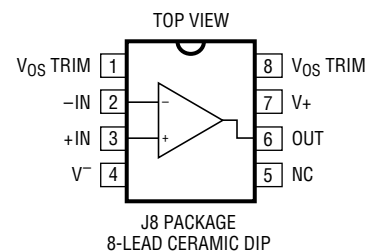
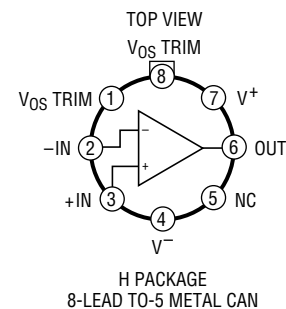

TABLE 1: ELECTRICAL CHARACTERISTICS (Pre-Irradiation) (Note 5)

SYMBOL	PARAMETER	CONDITIONS	NOTES	$T_A = 25^\circ\text{C}$			SUB-GROUP	$-55^\circ\text{C} \leq T_A \leq 125^\circ\text{C}$			SUB-GROUP	UNITS
				MIN	TYP	MAX		MIN	TYP	MAX		
V_{OS}	Input Offset Voltage		1			75	4		200	2,3	μV	
$\frac{\Delta V_{OS}}{\Delta \text{Temp}}$	Avg Input Offset Voltage Drift: Without External Trim With External Trim	Null Pot = 20k Ω	3 3						1.3 1.3		$\mu\text{V}/^\circ\text{C}$ $\mu\text{V}/^\circ\text{C}$	
$\frac{\Delta V_{OS}}{\Delta \text{Time}}$	Long-Term Input Offset Voltage Stability		2,3			1					$\mu\text{V}/\text{Mo}$	
I_{OS}	Input Offset Current					2.8	1		5.6	2,3	nA	
$\frac{\Delta I_{OS}}{\Delta \text{Temp}}$	Avg Input Bias Current Drift		3						50		$\text{pA}/^\circ\text{C}$	
I_B	Input Bias Current					± 3	1		± 6	2,3	nA	
$\frac{\Delta I_B}{\Delta \text{Temp}}$	Avg Input Bias Current Drift		3						50		$\text{pA}/^\circ\text{C}$	
e_n	Input Noise Voltage	0.1Hz to 10Hz	3			0.6					$\mu\text{V}_{\text{P-P}}$	
	Input Noise Voltage Density	$f_0 = 10\text{Hz}$ $f_0 = 100\text{Hz}$ $f_0 = 1000\text{Hz}$	4 3 3			18 13 11					$\text{nV}/\sqrt{\text{Hz}}$ $\text{nV}/\sqrt{\text{Hz}}$ $\text{nV}/\sqrt{\text{Hz}}$	
i_n	Input Noise Current	0.1Hz to 10Hz	3			30					$\text{pA}_{\text{P-P}}$	
	Input Noise Current Density	$f_0 = 10\text{Hz}$ $f_0 = 100\text{Hz}$ $f_0 = 1000\text{Hz}$	3 3 3			0.80 0.23 0.17					$\text{pA}/\sqrt{\text{Hz}}$ $\text{pA}/\sqrt{\text{Hz}}$ $\text{pA}/\sqrt{\text{Hz}}$	
R_{IN}	Input Resistance: Differential Mode Common Mode		3	20	200						M Ω G Ω	
	Input Voltage Range		3	± 13.5				± 13.5			V	
CMRR	Common-Mode Rejection Ratio	$V_{CM} = \pm 13\text{V}$		110			1	106		2,3	dB	
PSRR	Power Supply Rejection Ratio	$V_S = \pm 3\text{V}$ to $\pm 18\text{V}$		100			1	94		2,3	dB	
A_{VOL}	Large-Signal Voltage Gain	$R_L \geq 2\text{k}$, $V_O = \pm 10\text{V}$ $R_L \geq 500\Omega$, $V_O = \pm 0.5\text{V}$ $V_S = \pm 3\text{V}$	3	200 150			4	150		5,6	V/mV V/mV	
V_{OUT}	Maximum Output Voltage Swing	$R_L \geq 10\text{k}$ $R_L \geq 2\text{k}$ $R_L \geq 1\text{k}$				± 12.5 ± 12.0 ± 10.5	4 4 4	± 12.0		5,6		
SR	Slew Rate	$R_L \geq 2\text{k}$	3	0.1							V/ μs	
GBW	Closed-Loop Bandwidth	$A_{VCL} = 1$	3	0.4							MHz	
P_D	Power Dissipation	$V_S = \pm 15\text{V}$ $V_S = \pm 3\text{V}$				120 6	1 1				mW mW	

TABLE 1A: ELECTRICAL CHARACTERISTICS (Post-Irradiation) (Note 6)

SYMBOL	PARAMETER	CONDITIONS	NOTES	10KRAD(Si)		20KRAD(Si)		50KRAD(Si)		100KRAD(Si)		200KRAD(Si)		UNITS
				MIN	MAX	MIN	MAX	MIN	MAX	MIN	MAX	MIN	MAX	
V_{OS}	Input Offset Voltage		1		90		150		200		250		300	μ V
I_{OS}	Input Offset Current				2.8		4		8		12		20	nA
I_B	Input Bias Current				± 3		± 10		± 25		± 50		± 100	nA
	Input Voltage Range		3	± 13.5		± 13.5		± 13.5		± 13.5		± 13.5		V
CMRR	Common-Mode Rejection Ratio	$V_{CM} = \pm 13V$		110		110		105		100		95		dB
PSRR	Power Supply Rejection Ratio	$V_S = \pm 3V$ to $\pm 18V$		100		100		100		95		90		dB
A_{VOL}	Large-Signal Voltage Gain	$R_L \geq 2k$, $V_O = \pm 10V$		200		200		180		150		120		V/mV
V_{OUT}	Maximum Output Voltage Swing	$R_L \geq 10k$		± 12.5		± 12.5		± 12.5		± 12.5		± 12.5		V
SR	Slew Rate	$R_L \geq 2k$		0.1		0.1		0.1		0.075		0.05		V/ μ s
P_D	Power Dissipation			120		120		120		120		120		mW

Note 1: Offset voltage is measured with high speed test equipment approximately 0.5 seconds after power is applied.

Note 2: Long-term input offset voltage stability refers to the averaged trend line of V_{OS} vs. time over extended periods after the first 30 days of operation. Excluding the initial hour of operation, changes in V_{OS} during the first 30 days are typically 2.5μ V.

Note 3: Parameter is guaranteed by design, characterization, or correlation to other tested parameters.

Note 4: 10Hz noise voltage density is sample tested on every lot to an LTPD of 15. Devices 100% tested at 10Hz are available on request.

Note 5: $V_S = \pm 15V$, $V_{CM} = 0V$, unless otherwise noted.

Note 6: $T_A = 25^\circ C$, $V_S = \pm 15V$, $V_{CM} = 0V$, unless otherwise noted.

TABLE 2: ELECTRICAL TEST REQUIREMENTS

MIL-STD-883 TEST REQUIREMENTS	SUBGROUP
Final Electrical Test Requirements (Method 5004)	1*,2,3,4,5,6
Group A Test Requirements (Method 5005)	1,2,3,4,5,6
Group B and D for Class S, and Group C and D for Class B End Point Electrical Parameters (Method 5005)	1

* PDA Applies to subgroup 1. See PDA Test Notes.

PDA Test Notes

The PDA is specified as 5% based on failures from group A, subgroup 1, tests after cooldown as the final electrical test in accordance with method 5004 of MIL-STD-883 Class B. The verified failures of group A, subgroup 1, after burn-in divided by the total number of devices submitted for burn-in in that lot shall be used to determine the percent for the lot.

Linear Technology Corporation reserves the right to test to tighter limits than those given.

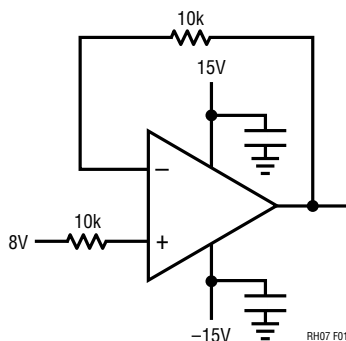
TOTAL DOSE BIAS CURRENT

TYPICAL PERFORMANCE CHARACTERISTICS

Positive Slew Rate

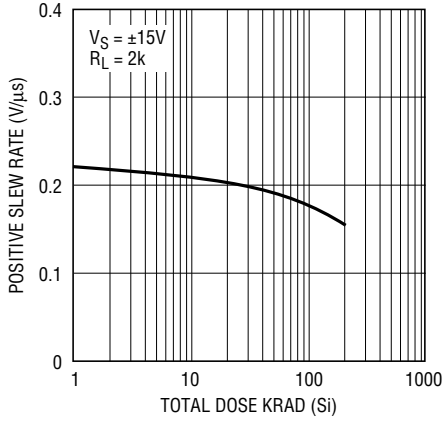

RH07 G01

Negative Slew Rate

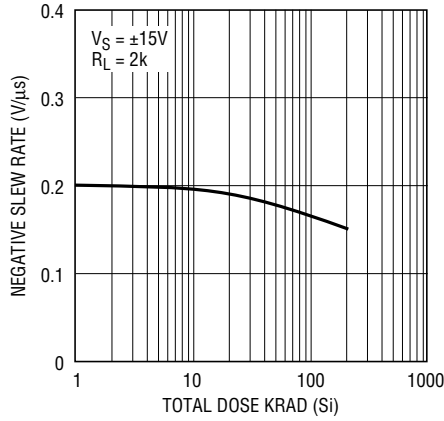

RH07 G02

Input Offset Voltage

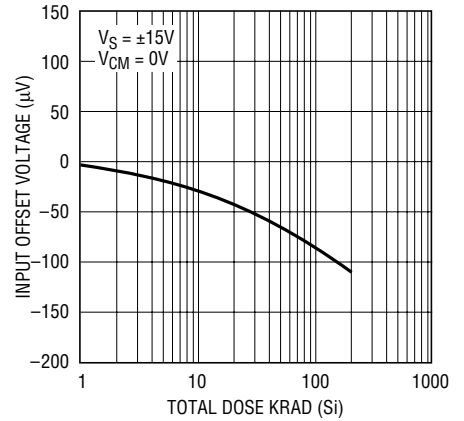

RH07 G03

Open-Loop Gain

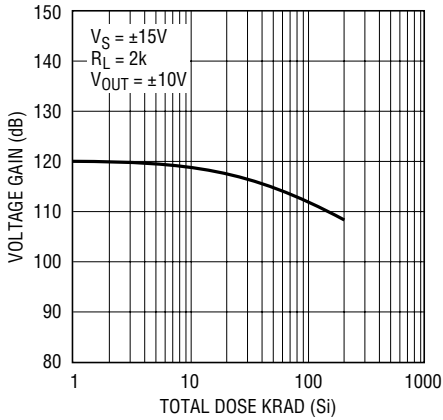

RH07 G04

Input Bias Current

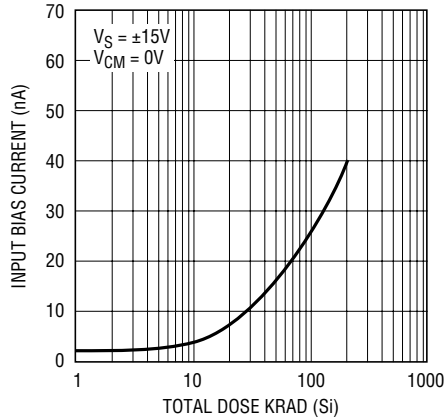

RH07 G05

Common-Mode Rejection Ratio

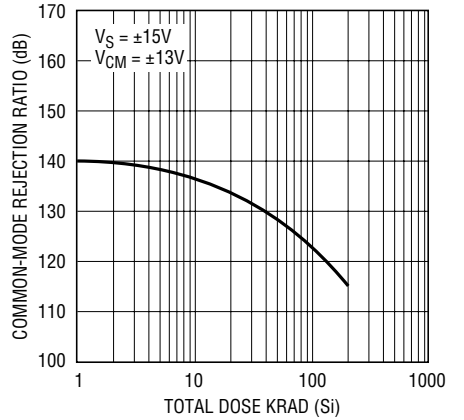

RH07 G06

Input Offset Current

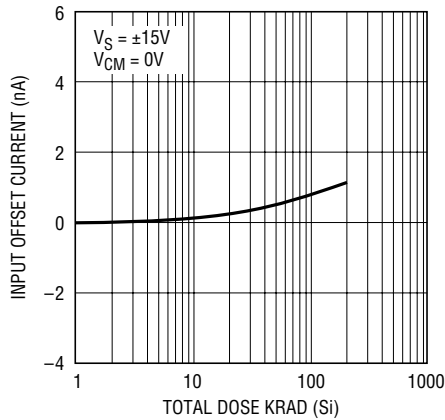

RH07 G07

Power Supply Rejection Ratio

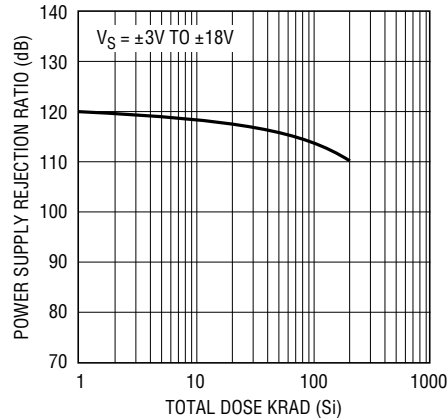

RH07 G08