





RJ-13

CERMET TRIMMERS

LIST OF PART NUMBERS

Adjustment position	Shape of terminal (Top view)	Form of packaging	Pieces in package
		Plastic bag	
Top adjustment		RJ-13P	50 pcs./pack
		RJ-13B	
		RJ-13PR	
Side adjustment (↑ Adjustment direction)		RJ-13S	
		RJ-13SR	

ELECTRICAL CHARACTERISTICS

Nominal resistance range	10 Ω ~ 5 MΩ
Resistance tolerance	± 10 %
Power ratings	0.75 W (70 °C) 0 W (120 °C)
Resistance law	(B) Linear law
Maximum input voltage	DC300 V or power rating, whichever is smaller
Maximum wiper current	100 mA or power rating, whichever is smaller
Effective electrical angle	230 ° (1 turn)
End resistance	1 % or 2 Ω, whichever is greater
C.R.V.	1 % or 3 Ω, whichever is greater
Operating temp. range	-55 ~ 120 °C
Temp. coefficient	10 Ω, 20 Ω, 5 MΩ : ± 250 10 ⁻⁶ /°C maximum 50 Ω ~ 2 MΩ : ± 100 10 ⁻⁶ /°C maximum
Insulation resistance	1000 MΩ minimum (DC500 V)
Dielectric strength	AC900 V, 60 s
Net weight	Approx. 1.90 g (RJ-13P) Approx. 4.50 g (RJ-13B) Approx. 2.15 g (RJ-13PR) Approx. 2.50 g (RJ-13S) Approx. 2.78 g (RJ-13SR)

<Nominal resistance values>

↻ 10 Ω	↻ 20 Ω	50 Ω	100 Ω	200 Ω	500 Ω	1 kΩ	2 kΩ	5 kΩ	10 kΩ
20 kΩ	↻ 25 kΩ	50 kΩ	100 kΩ	200 kΩ	↻ 250 kΩ	500 kΩ	1 MΩ	2 MΩ	↻ 5 MΩ

Fig. 1

※ The above part numbers are all available with the respective combination of <Nominal resistance values> (Fig. 1).
 ※ Verify the above part numbers when placing orders.

The products indicated by ↻ mark are manufactured upon receipt of order basis.

MECHANICAL CHARACTERISTICS

Mechanical angle	270 ° (1 turn)
Operating torque	3 ~ 35 mN·m {30.6~357 gf·cm}
Stop strength	100 mN·m {1.02 kgf·cm}
Rotational life	200 cycles 10 Ω ~ 200 Ω [Δ R/R ≤ ± (0.5 Ω + 3 %)] 500 Ω ~ 5 MΩ [Δ R/R ≤ ± (0.5 Ω + 2 %)]
Terminal to strength	20 N {2.04 kgf} minimum (Tensile strength)
Thrust to rotor	10 N {1.02 kgf} minimum
Solderability	245 ± 3 °C, 2 ~ 3 s

{ } : eference only

ENVIRONMENTAL CHARACTERISTICS

Test item	Test conditions	Specifications
Thermal shock	-65 ~ 125 °C (0.5 h), 5 cycles	[Δ R/R ≤ 1 %] [S.S. ≤ 1 %]
Humidity	-10 ~ 65 °C (80 ~ 98 %), 10 cycles, 240 h	[Δ R/R ≤ 1 %]
Shock	981 m/s ² , 6 ms 6 directions for 3 times each	[Δ R/R ≤ 1 %] [S.S. ≤ 1 %]
Vibration	(Amplitude) 1.52 mm or (Acceleration) 196 m/s ² , 10 ~ 2000 Hz, 3 directions, 12 times each	
Load life	70 °C, 0.75 W, 1000 h	[Δ R/R ≤ 2 %] [S.S. ≤ 1 %]
Low temp. operation	-55 °C, 2 h	[Δ R/R ≤ 1 %] [S.S. ≤ 2 %]
High temp. exposure	120 °C, 250 h	[Δ R/R ≤ 2 %] [S.S. ≤ 2 %]
Immersion seal	85 °C, 60 s	No leaks (No continuous bubbles)
Soldering heat	Flow 260 ± 3 °C, 5 ~ 6 s, two times maximum	[Δ R/R ≤ 1 %]
	Manual soldering 380 ± 10 °C, 3 ~ 4 s	

Δ R/R : Change in total resistance
S.S. : Setting stability

RJ-13

CERMET TRIMMERS

MAXIMUM INPUT RATINGS

Nominal resistance value (Ω)	Resistance code	Maximum input voltage (V)	Maximum wiper current (mA)
<ul style="list-style-type: none"> ➔ 10 ➔ 20 50 100 200 500 	<ul style="list-style-type: none"> 100 200 500 101 201 501 	<ul style="list-style-type: none"> 1.00 2.00 5.00 8.66 12.2 19.4 	<ul style="list-style-type: none"> 100 100 100 86.6 61.0 38.8
<ul style="list-style-type: none"> 1 k 2 k 5 k 10 k 20 k ➔ 25 k 50 k 	<ul style="list-style-type: none"> 102 202 502 103 203 253 503 	<ul style="list-style-type: none"> 27.4 38.7 61.2 86.6 122 137 194 	<ul style="list-style-type: none"> 27.4 19.3 12.2 8.66 6.10 5.48 3.88
<ul style="list-style-type: none"> ➔ 100 k ➔ 200 k ➔ 250 k 500 k ➔ 1 M ➔ 2 M ➔ 5 M 	<ul style="list-style-type: none"> 104 204 254 504 105 205 505 	<ul style="list-style-type: none"> 274 300 300 300 300 300 300 	<ul style="list-style-type: none"> 2.74 1.50 1.20 0.60 0.30 0.15 0.06

The products indicated by ➔ mark are manufactured upon receipt of order basis.

OUTLINE DIMENSIONS

Unless otherwise specified, tolerance: ± 0.3 (Unit: mm)

RJ-13P Top adjustment

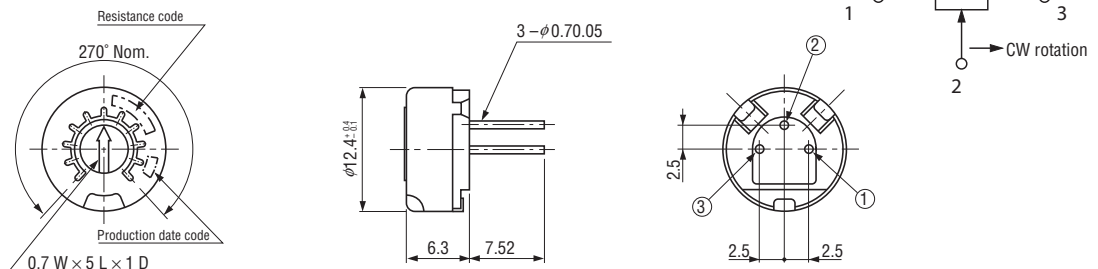

RJ-13B Panel mount

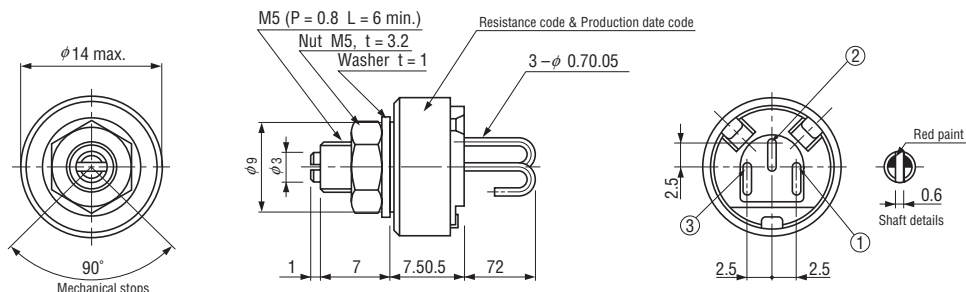

RJ-13PR Top adjustment with knob

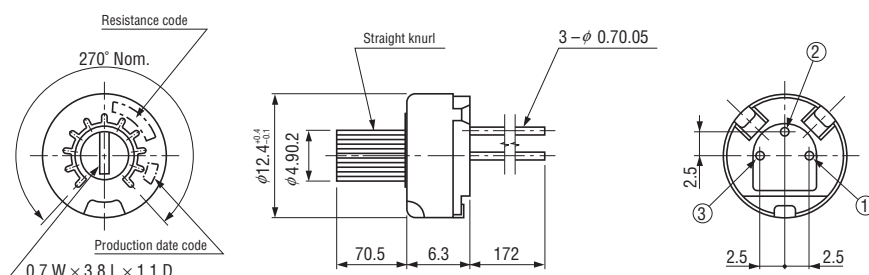

RJ-13

CERMET TRIMMERS

OUTLINE DIMENSIONS

RJ-13S Side adjustment

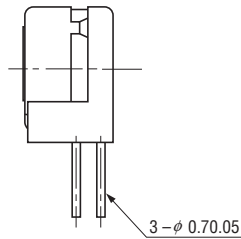
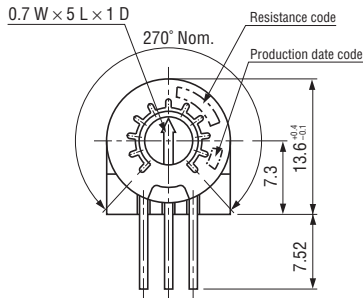

Unless otherwise specified, tolerance: ± 0.3 (Unit: mm)

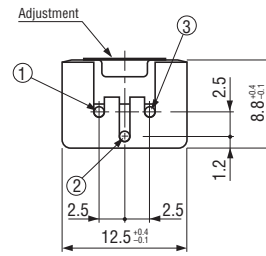
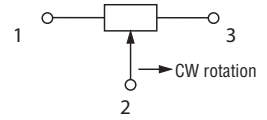

RJ-13SR Side adjustment with knob

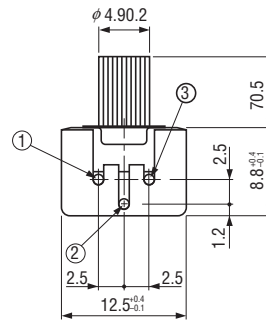
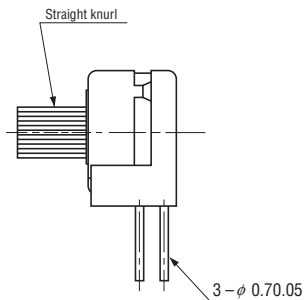
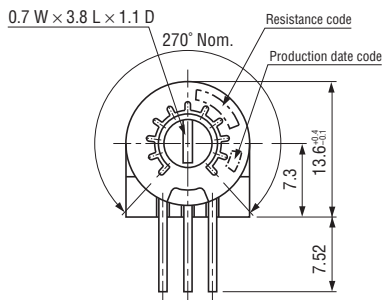

PACKAGING SPECIFICATIONS

<Bulk pack specifications>

- Unit of bulk pack in a plastic bag is 25 pcs. per pack, only that RJ-13P is 50 pcs. per pack.
- Boxing of bulk in a plastic bag is performed with 50 pcs. per box, only that RJ-13P is 100 pcs. per box.