

# Switching (30V, 6A)

## RK4936

●Features

- 1) Low Qg.
- 2) Low on-resistance.
- 3) Excellent resistance to damage from static electricity.

●Structure

Silicon N-channel  
MOS FET

●Equivalent circuit

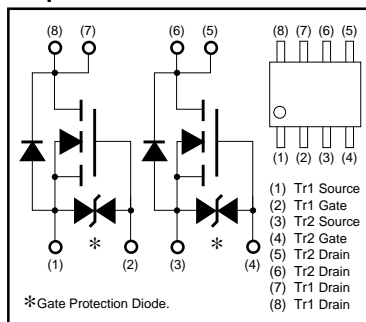

\* A protection diode is included between the gate and the source terminals to protect the diode against static electricity when the product is in use. Use a protection circuit when the fixed voltage are exceeded.

●External dimensions (Units : mm)

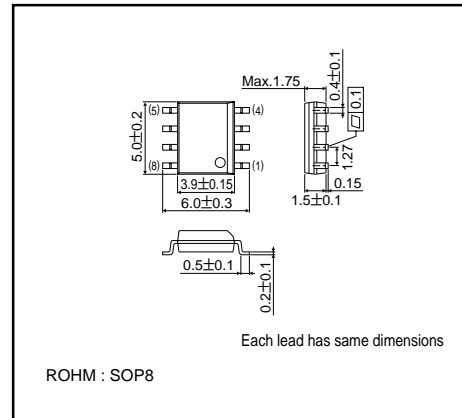

●Absolute maximum ratings (Ta = 25°C)

Parameter	Symbol	Limits	Unit
Drain-Source Voltage	V <sub>DSS</sub>	30	V
Gate-Source Voltage	V <sub>GSS</sub>	±20	V
Drain Current	Continuous	I <sub>D</sub>	6 A
	Pulsed	I <sub>DP</sub> *	24 A
Reverse Drain Current	Continuous	I <sub>DR</sub>	6 A
	Pulsed	I <sub>DRP</sub> *	24 A
Source Current (Body Diode)	Continuous	I <sub>S</sub>	1.3 A
	Pulsed	I <sub>SP</sub> *	5.2 A
Total Power Dissipation(Tc=25°C)	P <sub>D</sub>	2	W
Channel Temperature	T <sub>ch</sub>	150	°C
Storage Temperature	T <sub>stg</sub>	-55~+150	°C

\*Pw≤10μs, Duty cycle≤1%

## Transistors

### ● Thermal resistance (Ta = 25°C)

Parameter	Symbol	Limits	Unit
Channel to Ambient	Rth(ch-A)	62.5	°C/W

### ● Electrical characteristics (Ta = 25°C)

Parameter	Symbol	Min.	Typ.	Max.	Unit	Test Conditions
Gate-Source Leakage	I <sub>GSS</sub>	–	–	±10	μA	V <sub>GS</sub> =±20V, V <sub>DS</sub> =0V
Drain-Source Breakdown Voltage	V <sub>(BR) DSS</sub>	30	–	–	V	I <sub>D</sub> =1mA, V <sub>GS</sub> =0V
Zero Gate Voltage Drain Current	I <sub>DSS</sub>	–	–	10	μA	V <sub>DS</sub> =30V, V <sub>GS</sub> =0V
Gate Threshold Voltage	V <sub>GS(th)</sub>	1.0	–	2.5	V	V <sub>DS</sub> =10V, I <sub>D</sub> =1mA
Static Drain-Source On-State Resistance	R <sub>DS(on)*</sub>	–	22	28	mΩ	I <sub>D</sub> =6A, V <sub>GS</sub> =10V
		–	32	42		I <sub>D</sub> =6A, V <sub>GS</sub> =4.5V
		–	40	52		I <sub>D</sub> =6A, V <sub>GS</sub> =4V
Forward Transfer Admittance	Y <sub>fs</sub>  *	5	–	–	S	I <sub>D</sub> =6A, V <sub>DS</sub> =10V
Input Capacitance	C <sub>iss</sub>	–	740	–	pF	V <sub>DS</sub> =10V
Output Capacitance	C <sub>oss</sub>	–	420	–	pF	V <sub>GS</sub> =0V
Reverse Transfer Capacitance	C <sub>rss</sub>	–	180	–	pF	f=1MHz
Turn-On Delay Time	t <sub>d(on)*</sub>	–	14	–	ns	I <sub>D</sub> =3A, V <sub>DD</sub> =15V
Rise Time	t <sub>r</sub> *	–	30	–	ns	V <sub>GS</sub> =10V
Turn-Off Delay Time	t <sub>d(off)*</sub>	–	55	–	ns	R <sub>L</sub> =5Ω
Fall Time	t <sub>f</sub> *	–	25	–	ns	R <sub>GS</sub> =10Ω
Total Gate Charge	Q <sub>g</sub> *	–	21	42	nC	V <sub>DD</sub> =15V
Gate-Source Charge	Q <sub>gs</sub> *	–	2.7	–	nC	V <sub>GS</sub> =10V
Gate-Drain Charge	Q <sub>gd</sub> *	–	5.6	–	nC	I <sub>D</sub> =6A

\* Pulsed

### ● Body diode characteristics (Source-Drain characteristics) (Ta = 25°C)

Parameter	Symbol	Min.	Typ.	Max.	Unit	Test Conditions
Forward Voltage	V <sub>SD</sub> *	–	–	1.5	V	I <sub>S</sub> =5.2A, V <sub>GS</sub> =0V
Reverse Recovery Time	t <sub>rr</sub> *	–	140	–	ns	I <sub>DR</sub> =5.2A, V <sub>GS</sub> =0V
Reverse Recovery Charge	Q <sub>rr</sub> *	–	140	–	nC	di/dt=100A/μs

\* Pulsed

Transistors

● Electrical characteristic curves

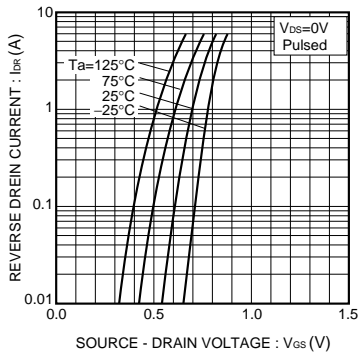

Fig.1 Reverse Drain Current vs. Source-Drain Voltage

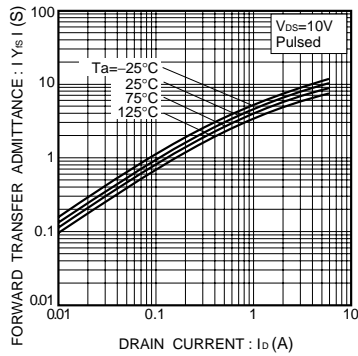

Fig.2 Forward Transfer Admittance vs. Drain Current

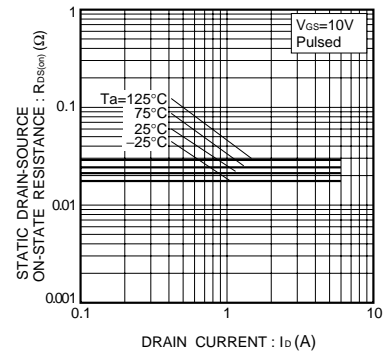

Fig.3 Static Drain-Source On-State Resistance vs. Drain Current ( I )

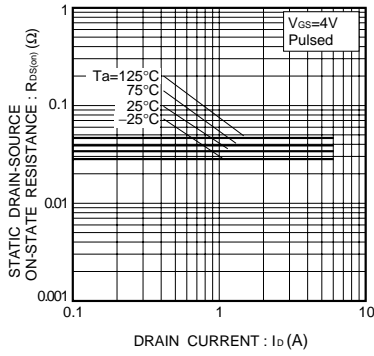

Fig.4 Static Drain-Source On-State Resistance vs. Drain Current ( II )

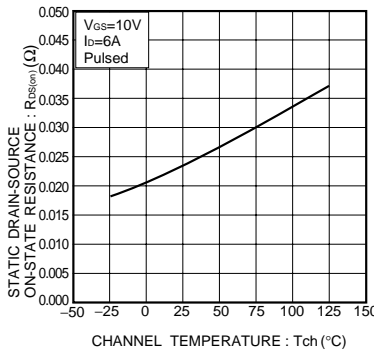

Fig.5 Static Drain-Source On-State Resistance vs. Channel Temperature

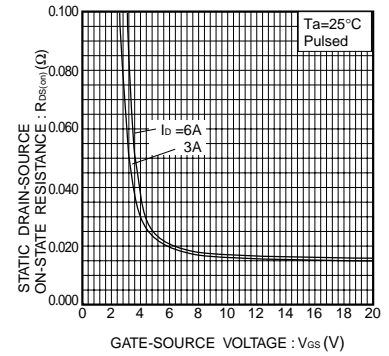

Fig.6 Static Drain-Source On-State Resistance vs. Gate-Source Voltage

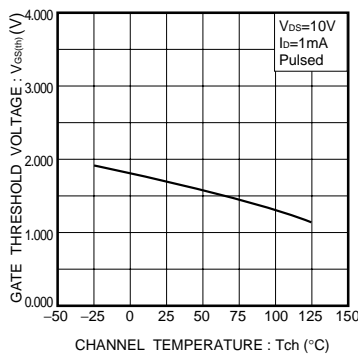

Fig.7 Gate Threshold Voltage vs. Channel Temperature

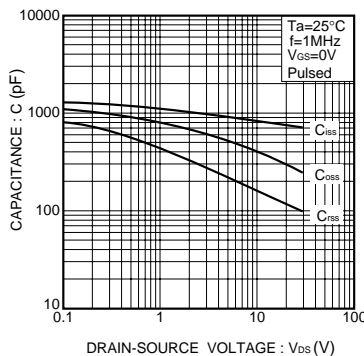

Fig.8 Typical Capacitance vs. Drain-Source Voltage

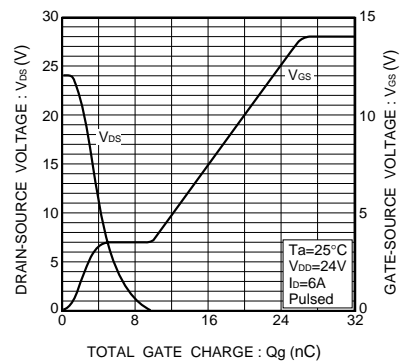

Fig.9 Dynamic Input Characteristics

Transistors

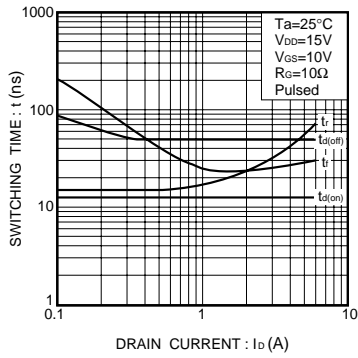

Fig.10 Switching Characteristics

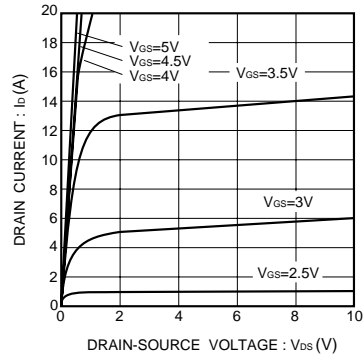

Fig.11 Typical Output Characteristics

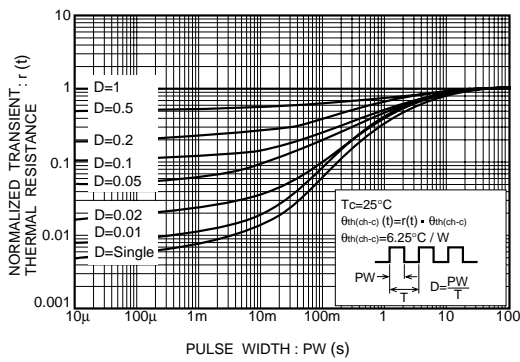

Fig.12 Normalized Transient Thermal Resistance vs. Pulse Width