



RLTCO-1064-400W



TECHNICAL DATA

High Power Infrared Diode Pumped Solid State Laser

Features

- Output Power: 400 W
- 1064 nm Emission Wavelength
- Small Size, Compact Package
- Water-Cooled, High Efficiency
- High Beam Quality, Stability and Reliability

Applications

- Metal Sheet Cutting
- Transparent Plastic Welding
- Laser Cleaning
- High-Speed Punching, laser Marking on Titanium Metal

Specifications (25°C)

Item	Symbol	Value	Unit
Optical Specifications			
CW Output Power	P_O	400	W
Center Wavelength	λ_C	1064	nm
YAG Center Height		50	mm
YAG Size		Ø5 x 136	mm
YAG Terminal		Flat / AR	-
Electrical Specifications			
Threshold Current	I_{TH}	≤ 10	A
Operating Current	I_{OP}	≤ 22	A
Structural			
Size	L x W x H	162 x 125 x 90	mm ³
Weight		2.6	kg
Absolute Maximum Ratings			
Operating Temperature	T_{OP}	+10 ... +30	°C
Storage Temperature	T_{STG}	-20 ... +70	°C
Cooling Style		Pure Water	
Cooling Water Temperatur		20	°C
Cooling Water Flow		30	L/min
Cooling Water Pressure		3.5	kg/cm ²
Optical		3.6	KW





Package Dimensons

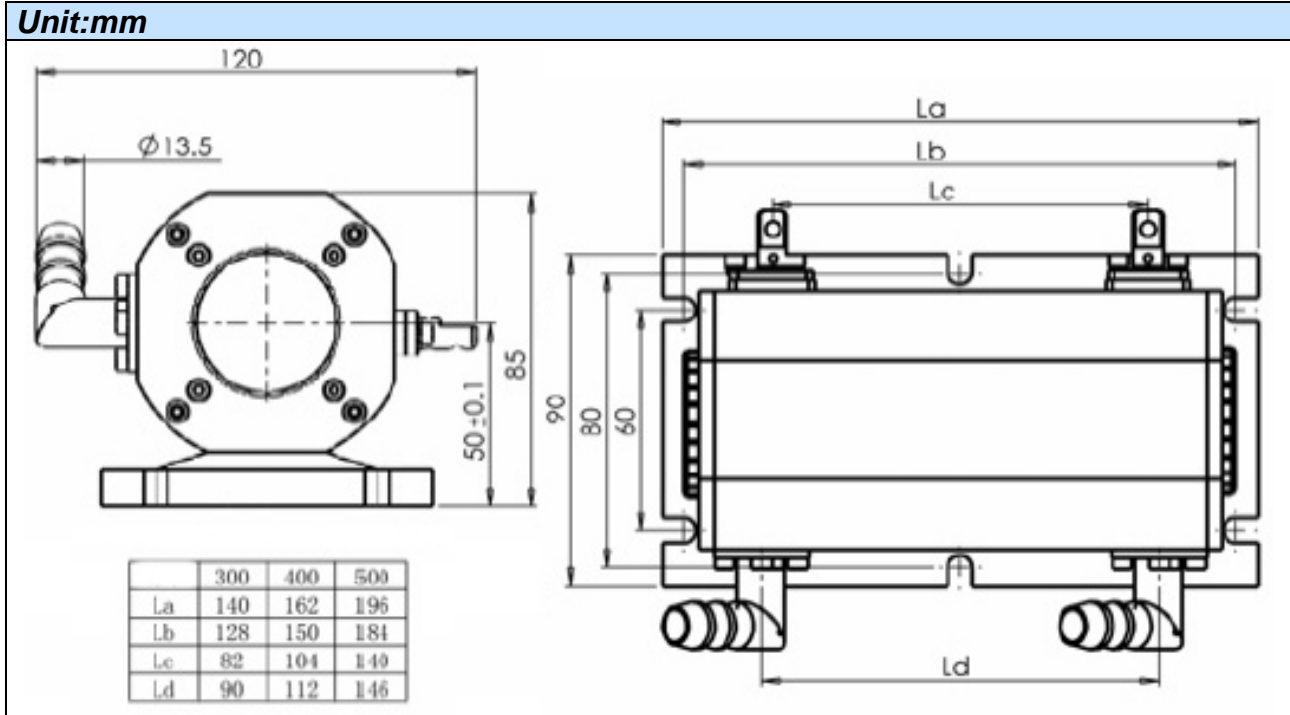

Safety of Laser light

- Laser Light can damage the human eyes and skin. Do not expose the eye or skin directly to any laser light and/or through optical lens. When handling the Lasers, wear appropriate safety glasses to prevent laser light, even any reflections from entering to the eye. Focused laser beam through optical instruments will increase the chance of eye hazard.
- These Lasers are emitting invisible light.



Cautions

1. Operating methode

- Confirm that electrical spike current generated by switching on and off does not exceed the maximum operating current level specified herein above as absolute maximum rating. Also, employ appropriat countermeasures to reduce chattering and/or overshooting in the circuit.

2. Static Electricity

- Static electricity or electrical surges will reduce and degrade the reliability of the LDs. It is recommended to use a wrist trap or anti-electrostatic glove when handling the product.

3. Absolute Maximum Rating

- Active layer of LDs shall have high current density and generate high electric field during its operation. In order to prevent excessive damage, the LD must be operated strictly below absolute maximum rating.



NOTE
LASERDIODE
MUST BE COOLED