

RMPA1751-102

3V PCS CDMA Power Amplifier Module

ADVANCED INFORMATION

Description

The RMPA1751-102 is a small-outline, power amplifier module (PAM) for Korean-band CDMA Personal Communication System (PCS) and Wireless Local Loop (WLL) applications. **Advanced DC power management provides an effective means to reduce current consumption during peak phone usage at backed-off RF power levels.** Analog or digital bias control enables the handset designer to optimize gain, linearity and power-added efficiency over a wide range of output powers, depending on the power-density profile of the wireless network. High power-added efficiency and excellent linearity are achieved using Raytheon's Heterojunction Bipolar Transistor (HBT) process.

Features

- ◆ **Advanced DC power-management extends average phone-battery life!**
- ◆ Single positive-supply operation and power-down mode.
- ◆ 35% power-added efficiency at +29 dBm CDMA average output power.
- ◆ Compact LCC package: 6.0 x 6.0 x 1.5 mm³.
- ◆ 50 ohm matched and DC blocked input/output



Absolute Maximum Ratings¹

Parameter	Symbol	Min	Typical	Max	Units
Supply Voltage	V _{cc}		3.5	6	V
Reference Voltage	V _{ref}	1.5	2.7	4.0	V
RF Input Power ²	P _{in}		+1	+7	dBm
Load VSWR	V _{SWR}		1.2:1	10:1	
Case Operating Temperature	T _c	-40	+25	+110	°C
Storage Temperature	T _{stg}	-55	+25	+150	°C

Electrical Characteristics³

Parameter	Min	Typ	Max	Unit
Operating Frequency	1720		1780	MHz
Gain				
(P _o =0 dBm)	21	24		dB
(P _o =28 dBm)	25	27		dB
Linear Output Power	29			dBm
Power-Added Efficiency				%
(P _o =16 dBm)		6.0		%
(P _o =28 dBm)	27	30		%
(P _o =29 dBm)		33		%
ACPR (Offset ≥ 1.25 MHz) ⁴		-49	-46	dBc
Noise Figure		5	6	dB
Noise Power (P _o ≤ 29 dBm)			-135	dBm/Hz
Input VSWR (50Ω)		2.0:1	2.5:1	
Output VSWR (50Ω)		3.5:1		

Parameter	Min	Typ	Max	Unit
Stability (All spurious) ⁵			-70	dBc
Harmonics (P _o ≤ 29 dBm) 2fo, 3fo, 4fo		-30		dBc
Quiescent Current				
(V _{ref} =2.7V)	60	80	100	mA
(V _{ref} =2.0V)		50		mA
(V _{ref} =1.7V)		35		mA
Power Shutdown Current ⁶		2	10	uA
V _{cc}	3.0	3.5	4.5	V
V _{ref}	1.7	2.7	3.2	V
I _{ref}		13		mA
Case Operating Temperature	-30		+85	°C

Notes:

1. No permanent damage with only one parameter set at extreme limit. Other parameters set to typical values.
2. Typical RF input power for CDMA P_{out}=+28 dBm.
3. All parameters met at T_c =+25°C, V_{cc} =+3.5V, V_{ref}=+2.7V, f=1750 MHz and load VSWR ≤ 1.2:1.
4. P_o ≤ 28 dBm at V_{cc}=3.5V; CDMA Waveform measured using the ratio of average power within a 1.23 MHz channel to average power within a 30 kHz bandwidth at + 1.25 MHz offset.
5. Load VSWR ≤ 6:1, all phase angles.
6. No applied RF signal. V_{cc}=+3.5V nominal, V_{ref}=+0.2V maximum.

Characteristic performance data and specifications are subject to change without notice.

RMPA1751-102

3V PCS CDMA Power Amplifier Module

Figure 1
Package Outline and Pin Designations

Dimensions in inches (mm)

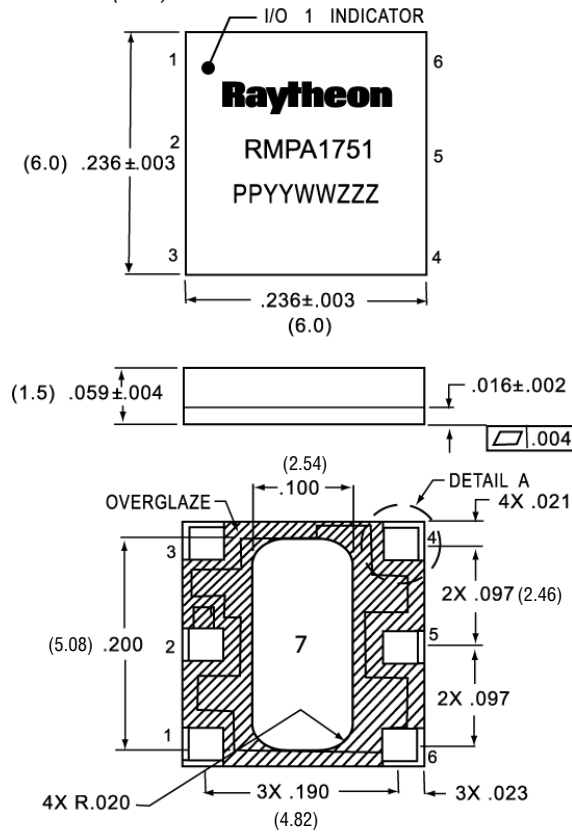

Pin #	Description
1	Vcc
2	RF In
3	VREF
4	N/C
5	RF Out
6	GND
7	GND

Figure 2
Functional Block Diagram

VCC=3.5V (nom)
VREF=2.7V (nom)
1720-1780 MHz
50 Ohms I/O

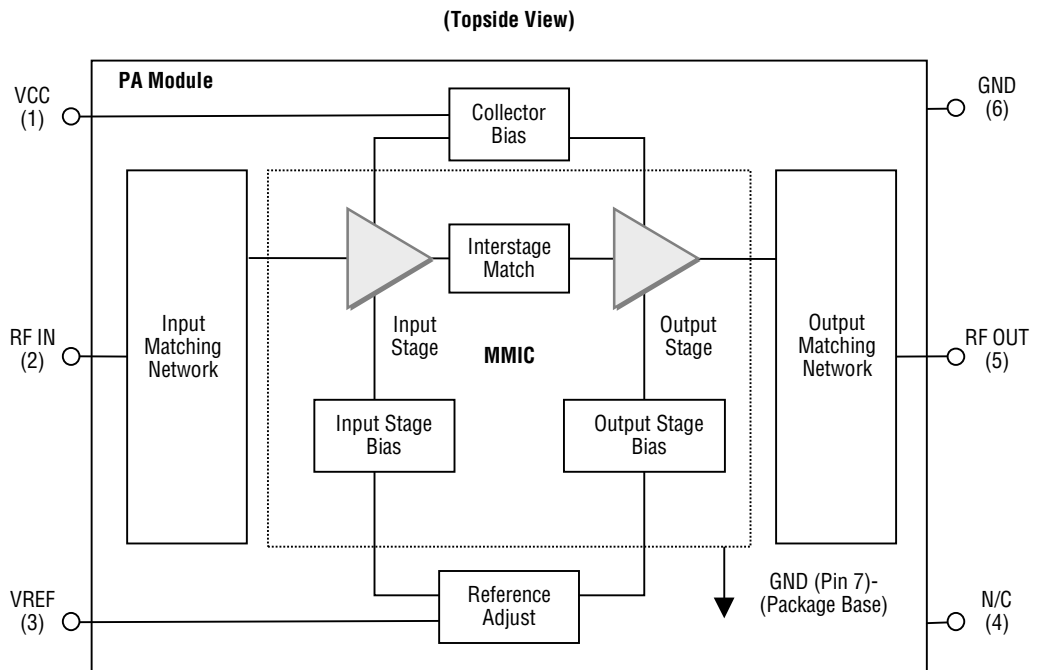

Characteristic performance data and specifications are subject to change without notice.

RMPA1751-102

3V PCS CDMA Power Amplifier Module

ADVANCED INFORMATION

Evaluation Board Instructions

With device marking oriented right side up, RF IN is on the left and RF OUT is on the right.

Blue wire is collector DC voltage input (pin 1). VCC= +3.5V nominal.

Brown wire is reference DC voltage input (pin 3). Vref=+ 2.7V nominal to obtain Iccq= 80mA. Operation at lower or higher quiescent currents can be achieved by decreasing or increasing Vref voltage relative to +2.7V.

First apply +3.5V to the collector supply (blue wire). Next apply +2.7V to the reference supply to brown wire. Quiescent collector current with no RF applied will be about 80 mA. Reference supply current with or without RF applied will be about 13 mA. When turning amplifier off, reverse power supply sequence.

Apply -20dBm RF input power at Korean PCS frequency (1720 -1780MHz). After making any initial small signal measurements at this drive level, input power may be increased up to a maximum of +6dBm for large signal, single-tone or digital CDMA measurements. Do not exceed +6dBm input power.

Figure 3
Evaluation Board
Layout and Schematic

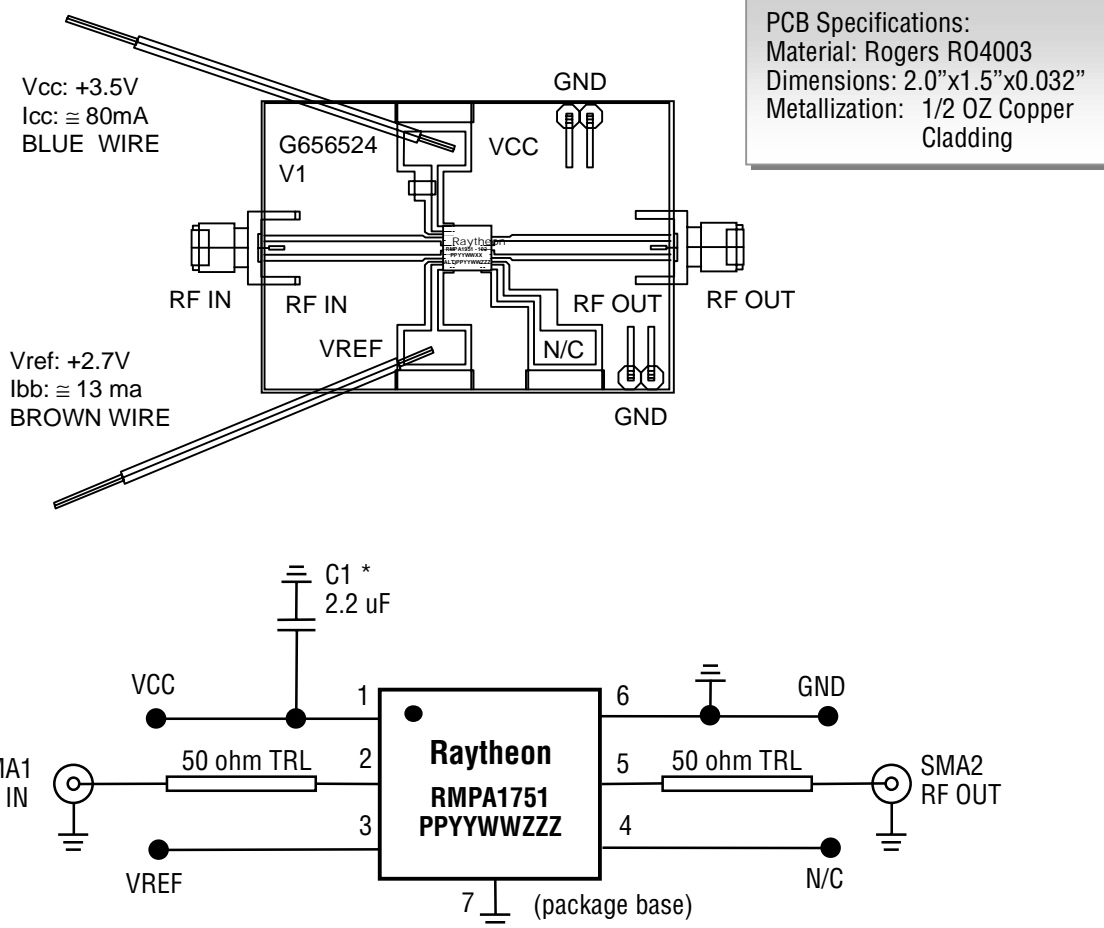

* Minimum VCC bypass capacitance recommended for best RF performance.

Characteristic performance data and specifications are subject to change without notice.

RMPA1751-102

3V PCS CDMA Power Amplifier Module

Application Information

CAUTION: THIS IS AN ESD SENSITIVE DEVICE.

◆ Precautions to Avoid Permanent Device Damage:

- Cleanliness: Observe proper handling procedures to ensure clean devices and PCBs. Devices should remain in their original packaging until component placement to ensure no contamination or damage to RF, DC & ground contact areas.
- Device Cleaning: Standard board cleaning techniques should not present device problems provided that the boards are properly dried to remove solvents or water residues.
- Static Sensitivity: Follow ESD precautions to protect against ESD damage:
 - A properly grounded static-dissipative surface on which to place devices.
 - Static-dissipative floor or mat.
 - A properly grounded conductive wrist strap for each person to wear while handling devices.
- General Handling: Handle the package on the top with a vacuum collet or along the edges with a sharp pair of bent tweezers. Avoiding damaging the RF, DC, & ground contacts on the package bottom. Do not apply excessive pressure to the top of the lid.
- Device Storage: Devices are supplied in heat-sealed, moisture-barrier bags. In this condition, devices are protected and require no special storage conditions. Once the sealed bag has been opened, devices should be stored in a dry nitrogen environment.

◆ Device Usage: Raytheon recommends the following procedures prior to assembly.

- Dry-bake devices at 125°C for 24 hours minimum. Note: The shipping trays cannot withstand 125°C baking temperature.
- Assemble the dry-baked devices within 7 days of removal from the oven.
- During the 7-day period, the devices must be stored in an environment of less than 60% relative humidity and a maximum temperature of 30°C
- If the 7-day period or the environmental conditions have been exceeded, then the dry-bake procedure must be repeated.

◆ Solder Materials & Temperature Profile: Reflow soldering is the preferred method of SMT attachment. Hand soldering is not recommended.

– Reflow Profile

- Ramp-up: During this stage the solvents are evaporated from the solder paste. Care should be taken to prevent rapid oxidation (or paste slump) and solder bursts caused by violent solvent out-gassing. A typical heating rate is 1- 2°C/sec.
- Pre-heat/soak: The soak temperature stage serves two purposes; the flux is activated and the board and devices achieve a uniform temperature. The recommended soak condition is: 120-150 seconds at 150°C.
- Reflow Zone: If the temperature is too high, then devices may be damaged by mechanical stress due to thermal mismatch or there may be problems due to excessive solder oxidation. Excessive time at temperature can enhance the formation of inter-metallic compounds at the lead/board interface and may lead to early mechanical failure of the joint. Reflow must occur prior to the flux being completely driven off. The duration of peak reflow temperature should not exceed 10 seconds. Maximum soldering temperatures should be in the range 215-220°C, with a maximum limit of 225°C.
- Cooling Zone: Steep thermal gradients may give rise to excessive thermal shock. However, rapid cooling promotes a finer grain structure and a more crack-resistant solder joint. The illustration below indicates the recommended soldering profile.

◆ Solder Joint Characteristics: Proper operation of this device depends on a reliable void-free attachment of the heatsink to the PWB. The solder joint should be 95% void-free and be a consistent thickness.

◆ Rework Considerations: Rework of a device attached to a board is limited to reflow of the solder with a heat gun. The device should not be subjected to more than 225°C and reflow solder in the molten state for more than 5 seconds. No more than 2 rework operations should be performed.

Characteristic performance data and specifications are subject to change without notice.

RMPA1751-102

3V PCS CDMA Power Amplifier Module

Figure 4

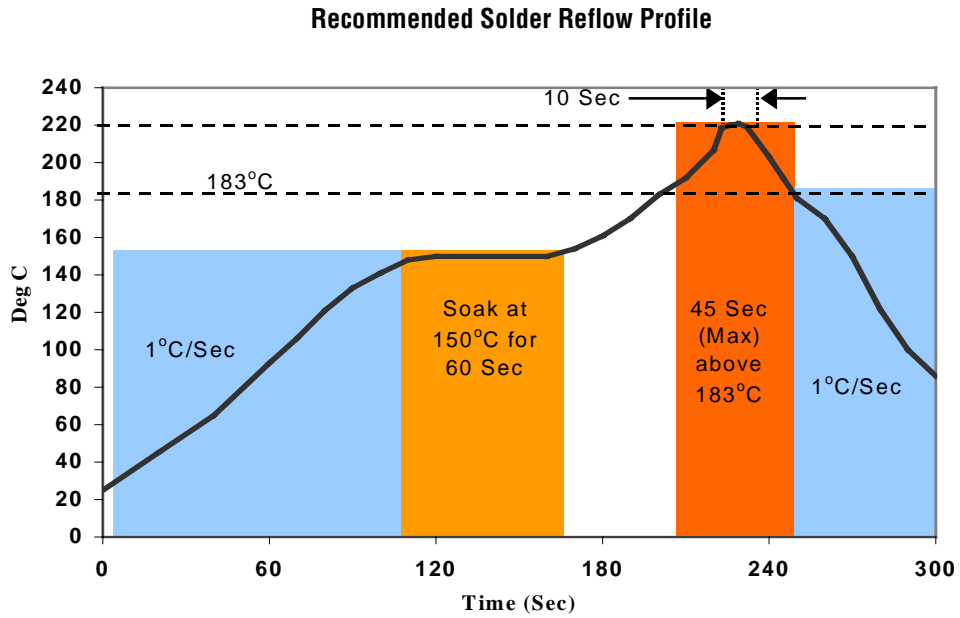

Characteristic performance data and specifications are subject to change without notice.

RMPA1751-102

3V PCS CDMA Power Amplifier Module

Performance Data
Figure 5

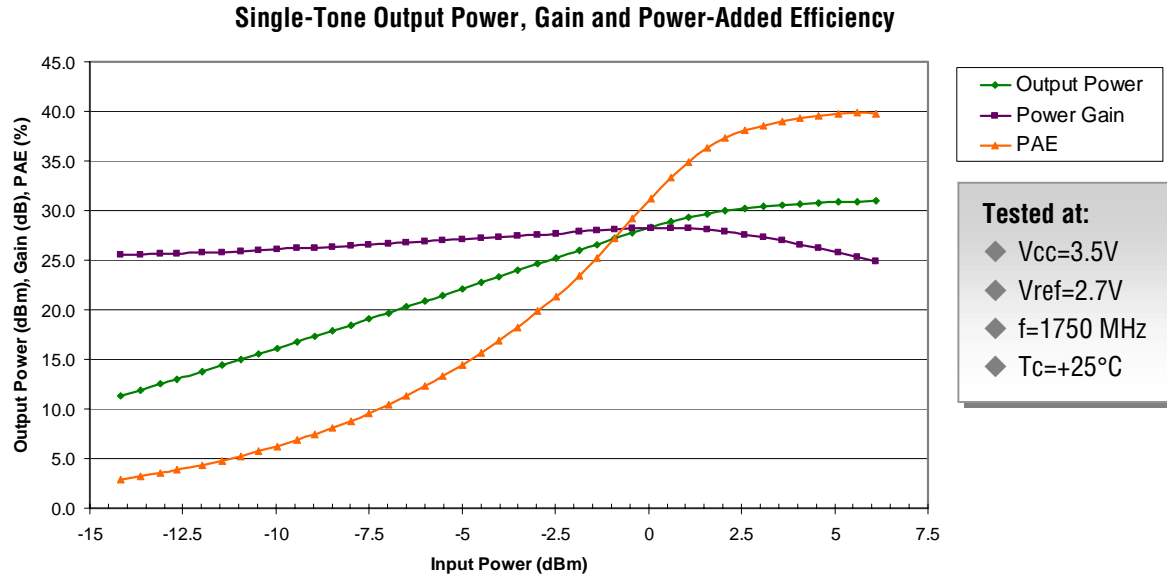
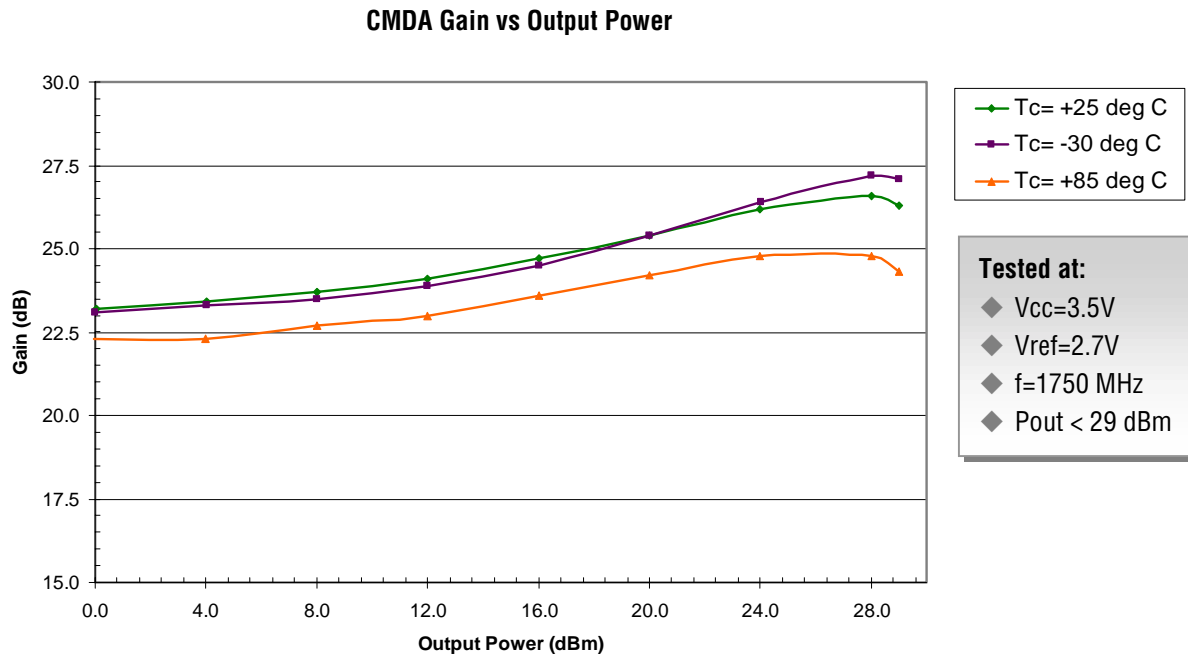

Figure 6



Characteristic performance data and specifications are subject to change without notice.

RMPA1751-102

3V PCS CDMA Power Amplifier Module

Figure 7

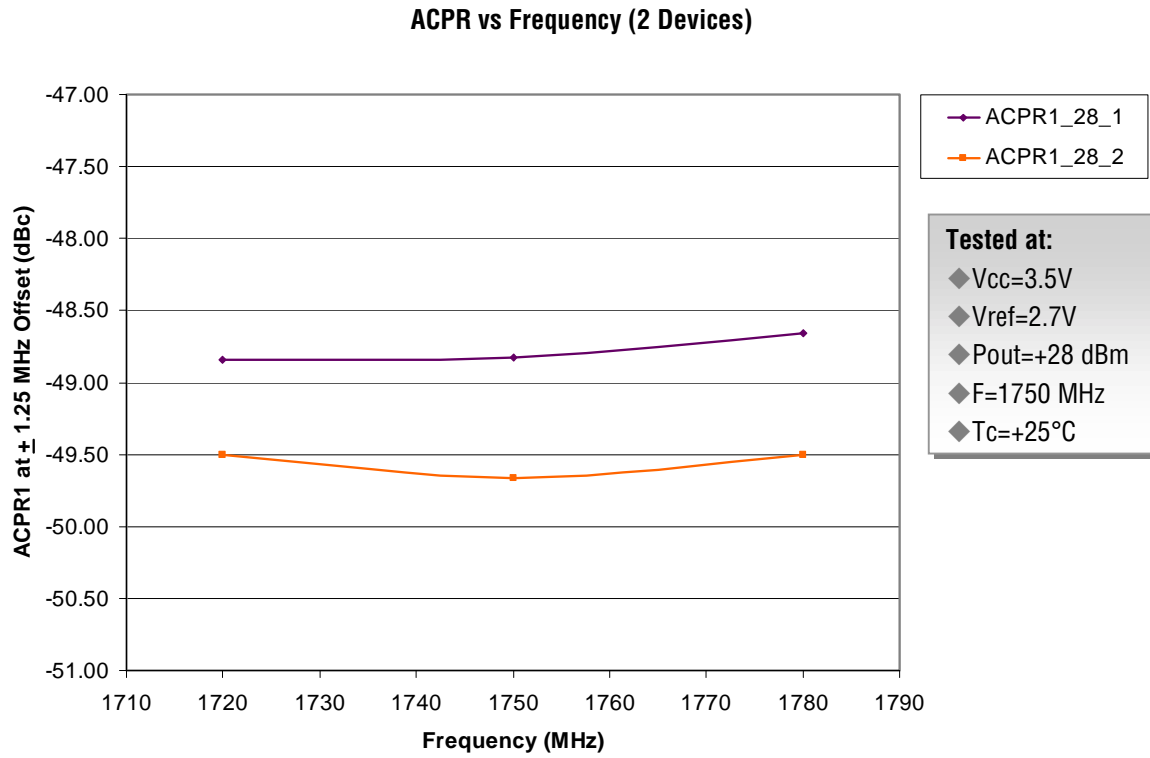
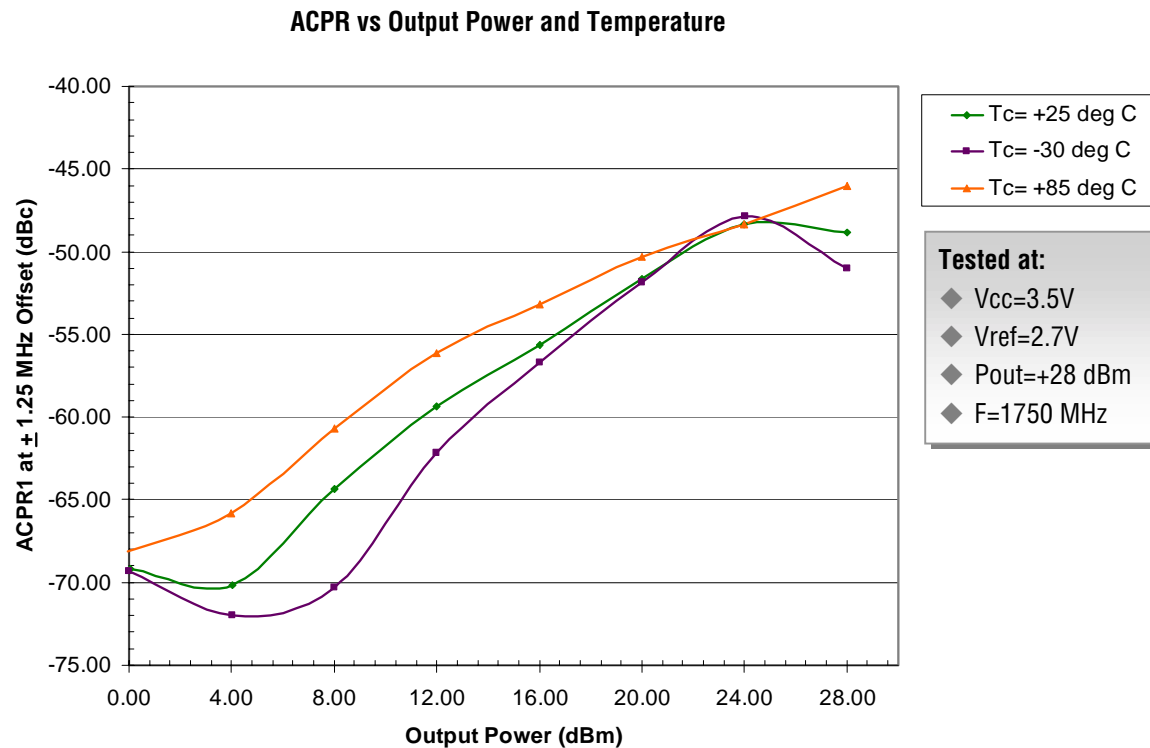

Figure 8



Characteristic performance data and specifications are subject to change without notice.

RMPA1751-102

3V PCS CDMA Power Amplifier Module

Figure 9

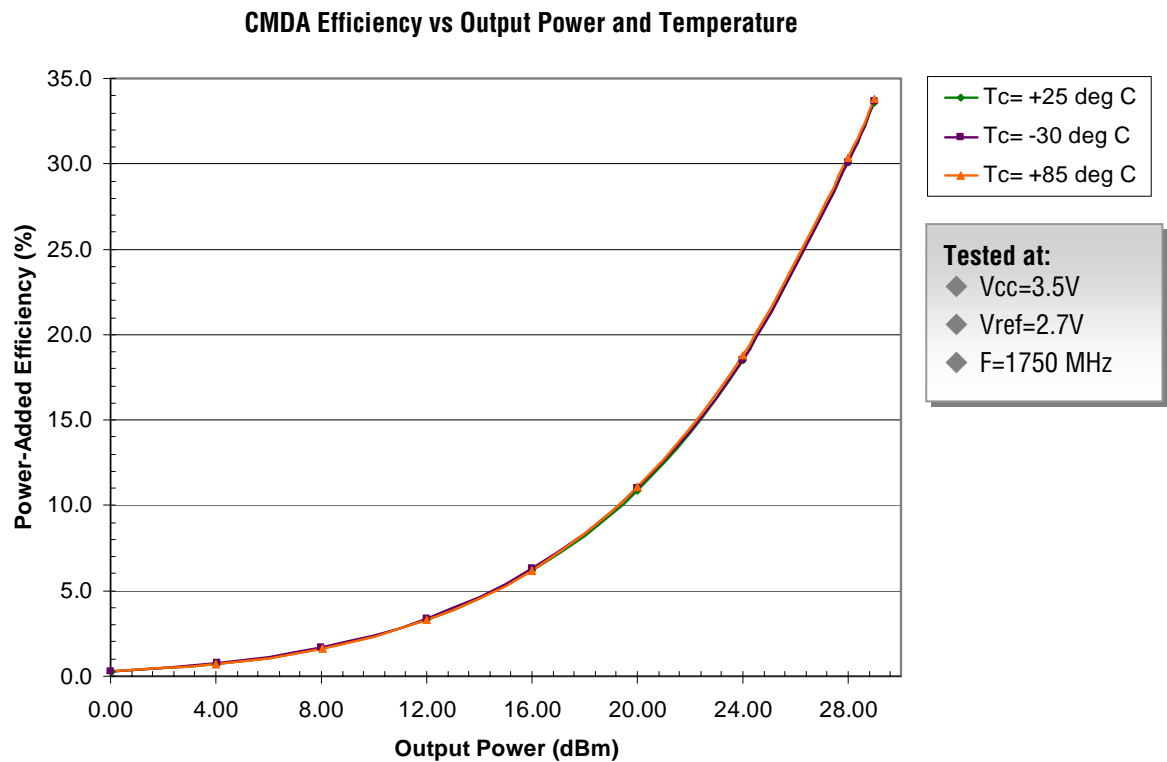
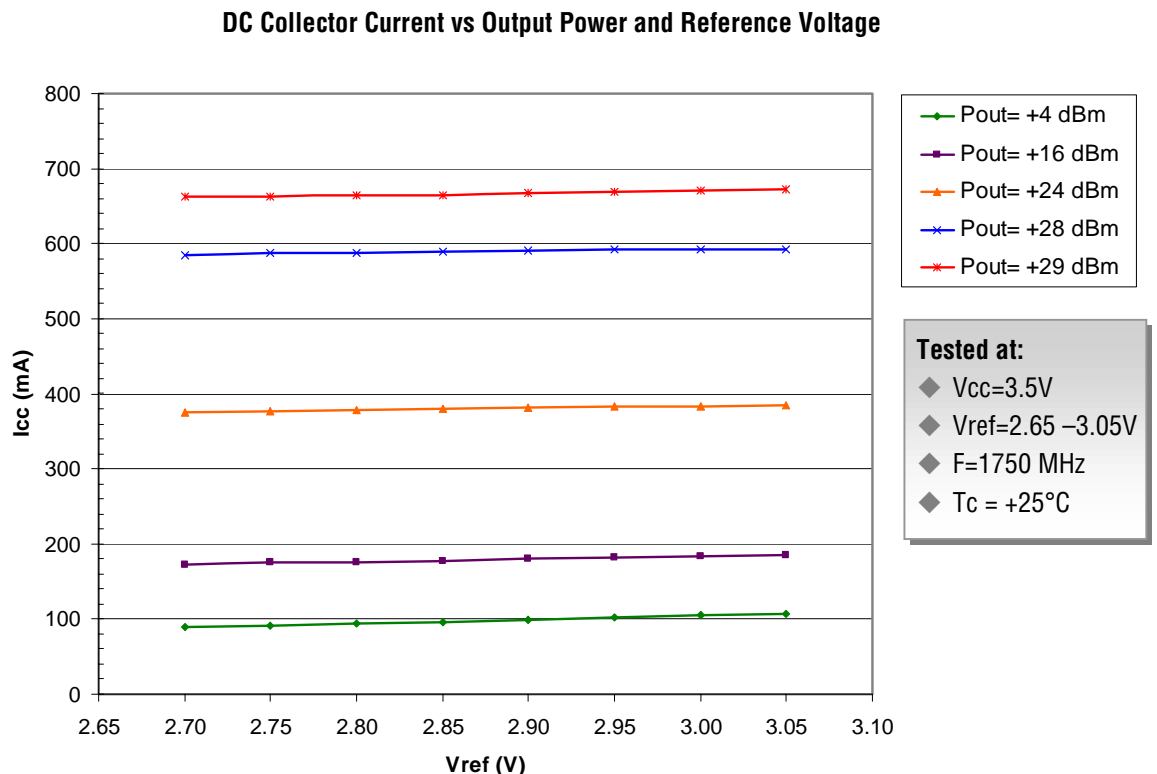

Figure 10



Characteristic performance data and specifications are subject to change without notice.

RMPA1751-102

3V PCS CDMA Power Amplifier Module

ADVANCED INFORMATION

DC Power Management

for Reduced-Power
Operating Modes

Many Cellular/PCS handsets can benefit from gain control and DC power management to optimize transmitter performance while operating at backed-off output power levels. Oftentimes, cellular systems will operate at 10-20 dB back-off from maximum-rated linear power and peak power-added efficiency. The ability to reduce current consumption under these conditions, without sacrificing linearity, is critical to extending battery life in next-generation handheld phones.

The RMPA1751-102 PA offers the ability to lower quiescent current by more than 60 percent and small-signal gain by up to 10 dB using a single control voltage (V_{ref}). Even with the amplifier biased for lowest current consumption, high linearity is maintained over the full operating temperature range and at output power levels up to +16 dBm. Bias and gain control through V_{ref} provides complete flexibility for the handset designer, allowing the user to define the operation by either an analog (continuously-variable) or digital (discrete-step) voltage input. As an example, reducing the V_{ref} voltage from 2.7V (nominal) to 1.7V (minimum) can lower PA current consumption by more than 20 percent at an output power of +16 dBm.

The following charts demonstrate analog and digital control techniques for minimizing DC power consumption at reduced RF output power levels. Figures 11 through 19 characterize analog control over a reference voltage (V_{ref}) range of 1.7V to 2.7V. Quiescent current is reduced to less than 30 mA and small-signal gain is reduced by 10 dB at $V_{ref}=1.7V$. Operating current at +16 dBm is also reduced by 20 percent, or 35 mA, at the lowest reference voltage. Figures 20 through 23 feature digital control using three discrete voltage levels (2.7V, 2.0V, 1.8V) to optimize linear PA performance over three output power ranges (< +4 dBm, +4 dBm to +16 dBm, >+16 dBm). Alternate output power ranges can be selected depending on the power-probability use in the cellular system.

DC Power Management

Application of Digital
Control Technique

Parameter	Symbol	Min	Typical	Max	Units	Conditions
Low-Power Range	P04			+4	dBm	$V_{ref}=1.8V$ typ
Current	Icc4			55	mA	
Gain	G4		13.5		dB	
Linearity	ACPR4		-50		dBc	
Mid-Power Range	P16	+4	+10	+16	dBm	$V_{ref}=2.0V$ typ
Current	Icc16			160	mA	
Gain	G16		19		dB	
Linearity	ACPR16		-50		dBc	
High-Power Range	P28	+16		+28	dBm	$V_{ref}=2.7V$ typ Pout=+28 dBm
Current	Icc28		560	660	mA	
Gain	G28		26		dB	
Linearity	ACPR28		-50		dBc	

Characteristic performance data and specifications are subject to change without notice.

RMPA1751-102

3V PCS CDMA Power Amplifier Module

Figure 11

Enhanced PAE vs Reference Voltage at Pout=+16 dBm (Analog Control)

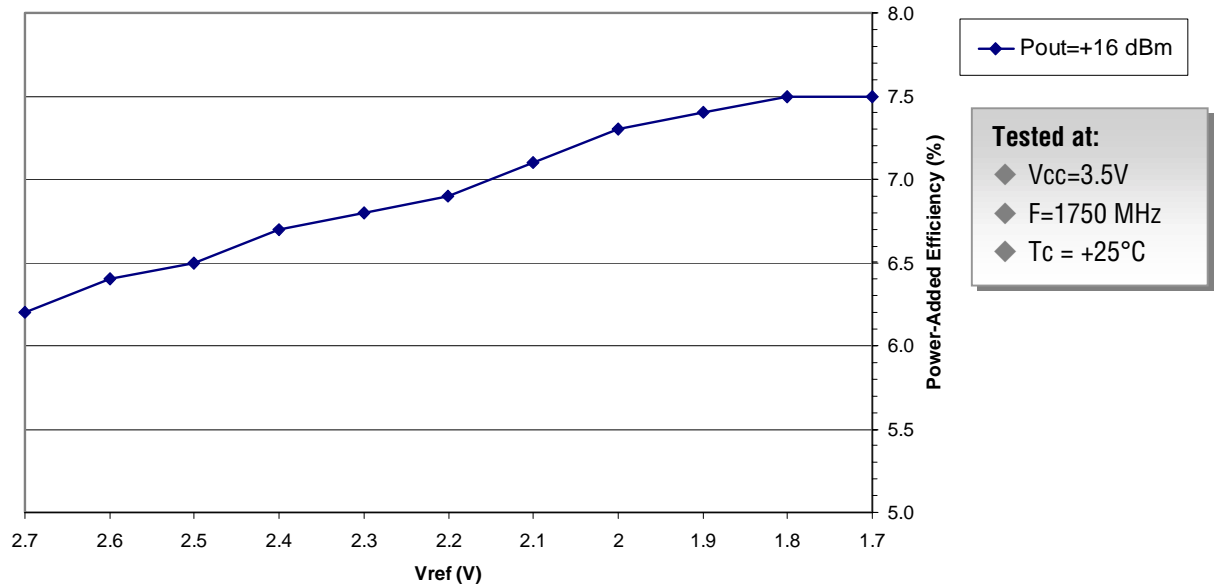
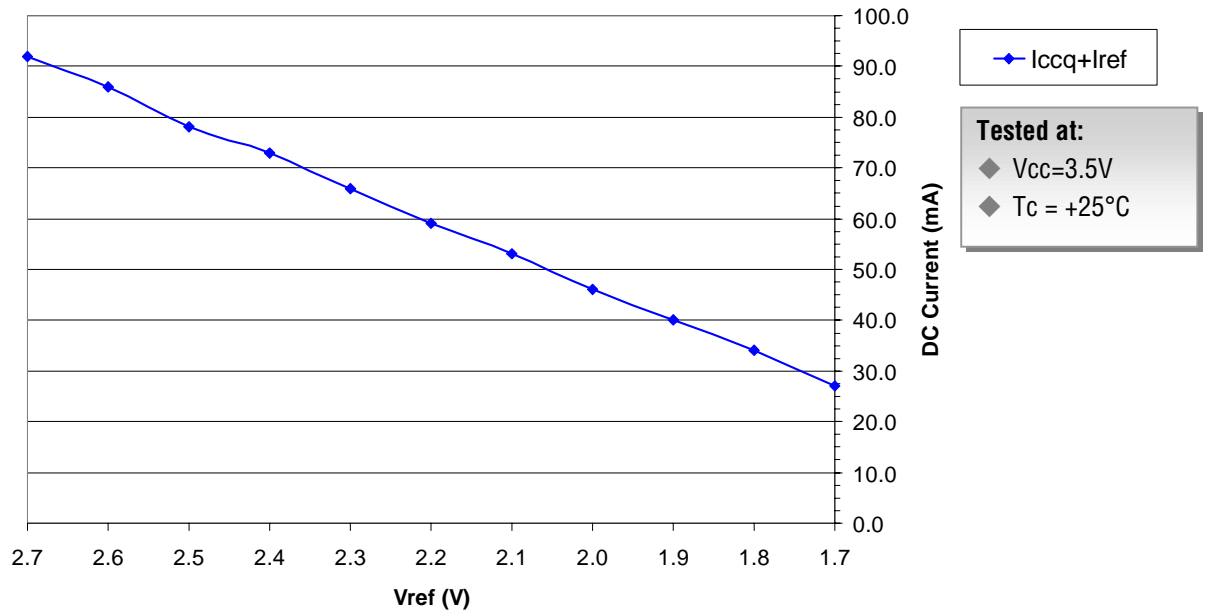

Figure 12

Total Quiescent Current vs Reference Voltage (Analog Control)



Characteristic performance data and specifications are subject to change without notice.

RMPA1751-102

3V PCS CDMA Power Amplifier Module

Figure 13

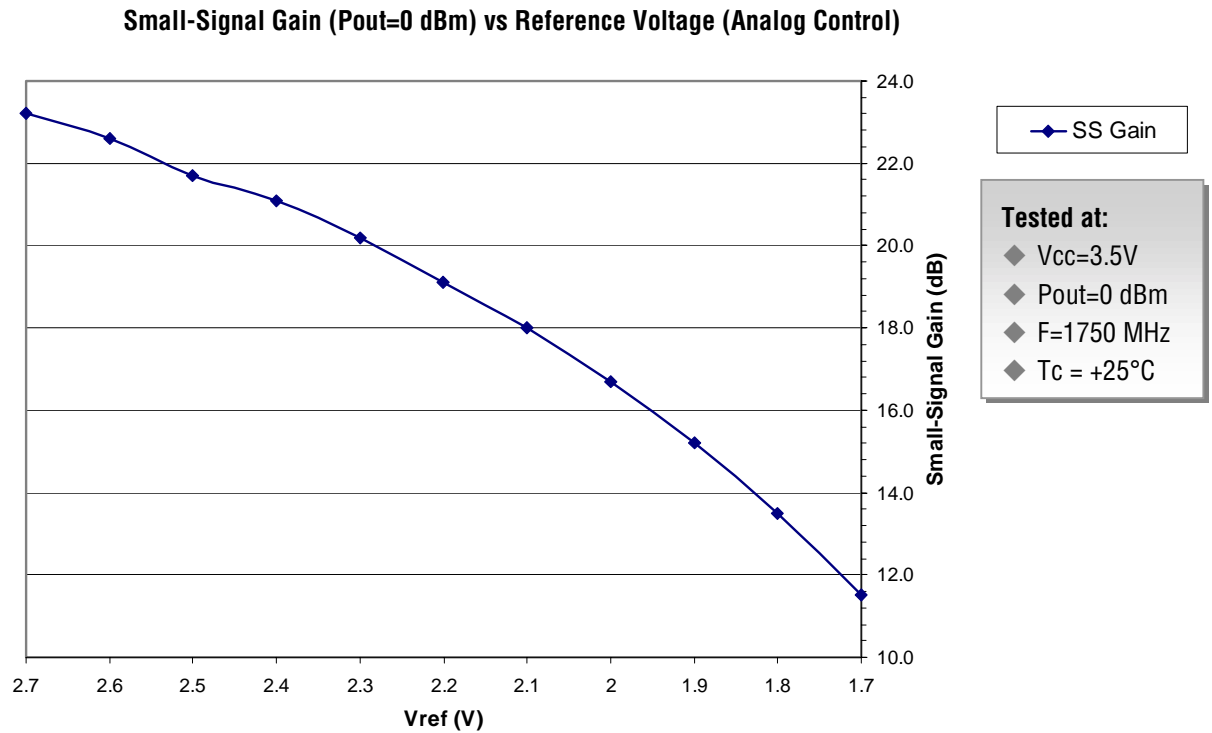
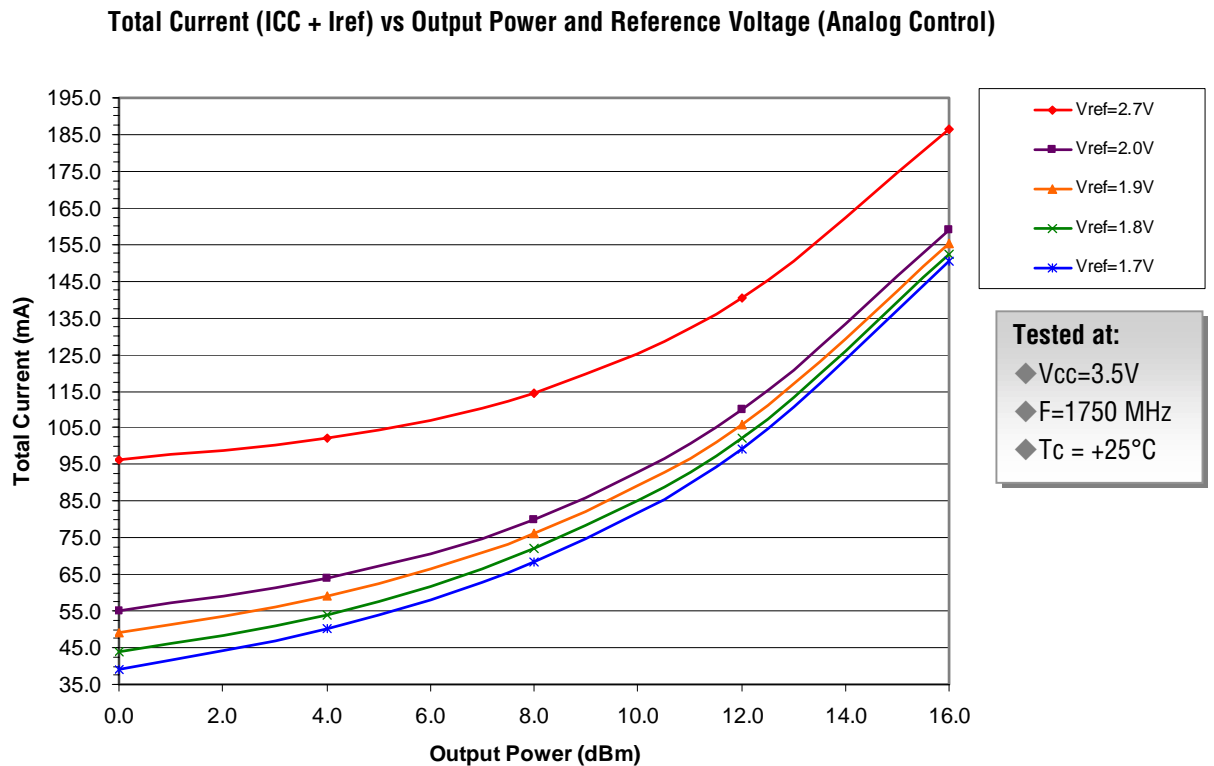

Figure 14



Characteristic performance data and specifications are subject to change without notice.

RMPA1751-102

3V PCS CDMA Power Amplifier Module

Figure 15

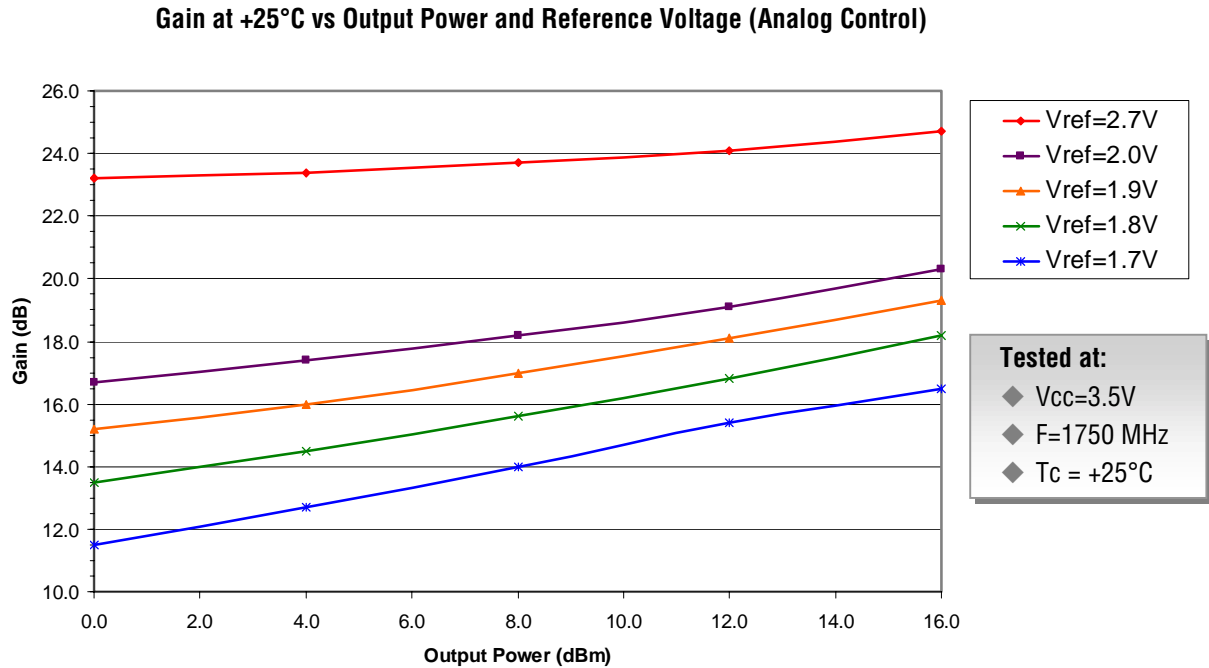
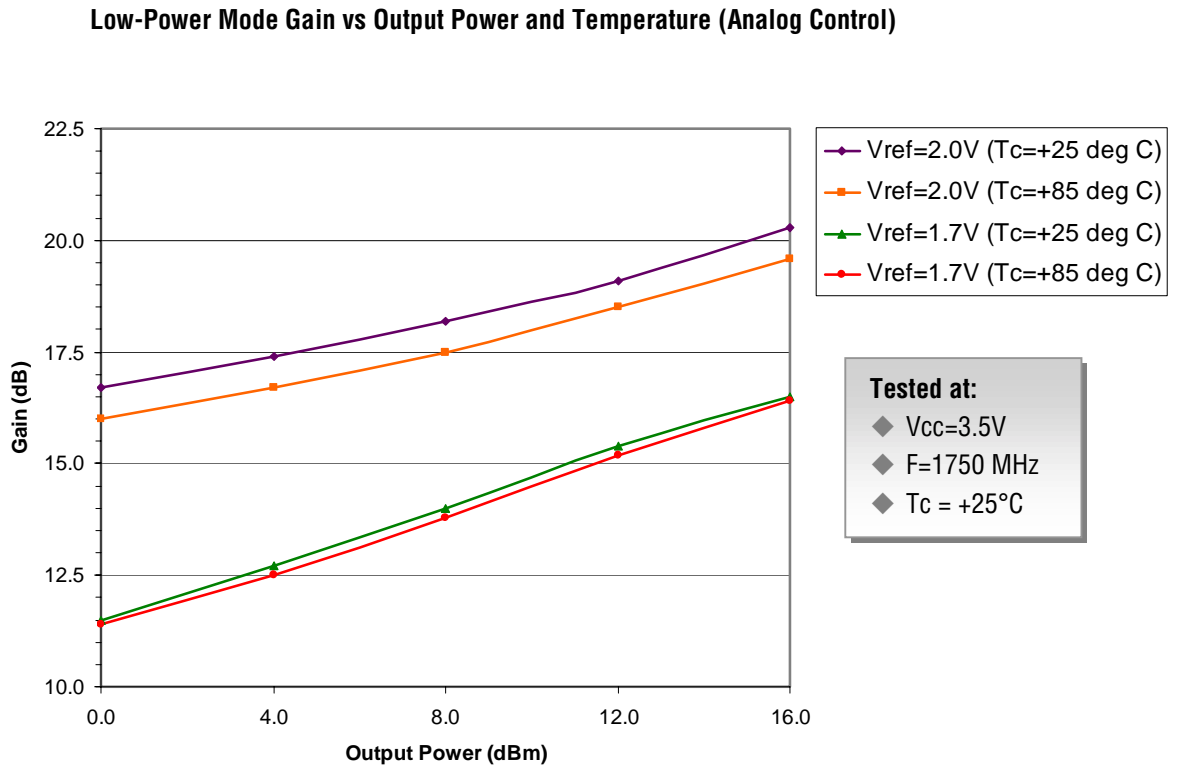

Figure 16



Characteristic performance data and specifications are subject to change without notice.

RMPA1751-102

3V PCS CDMA Power Amplifier Module

Figure 17

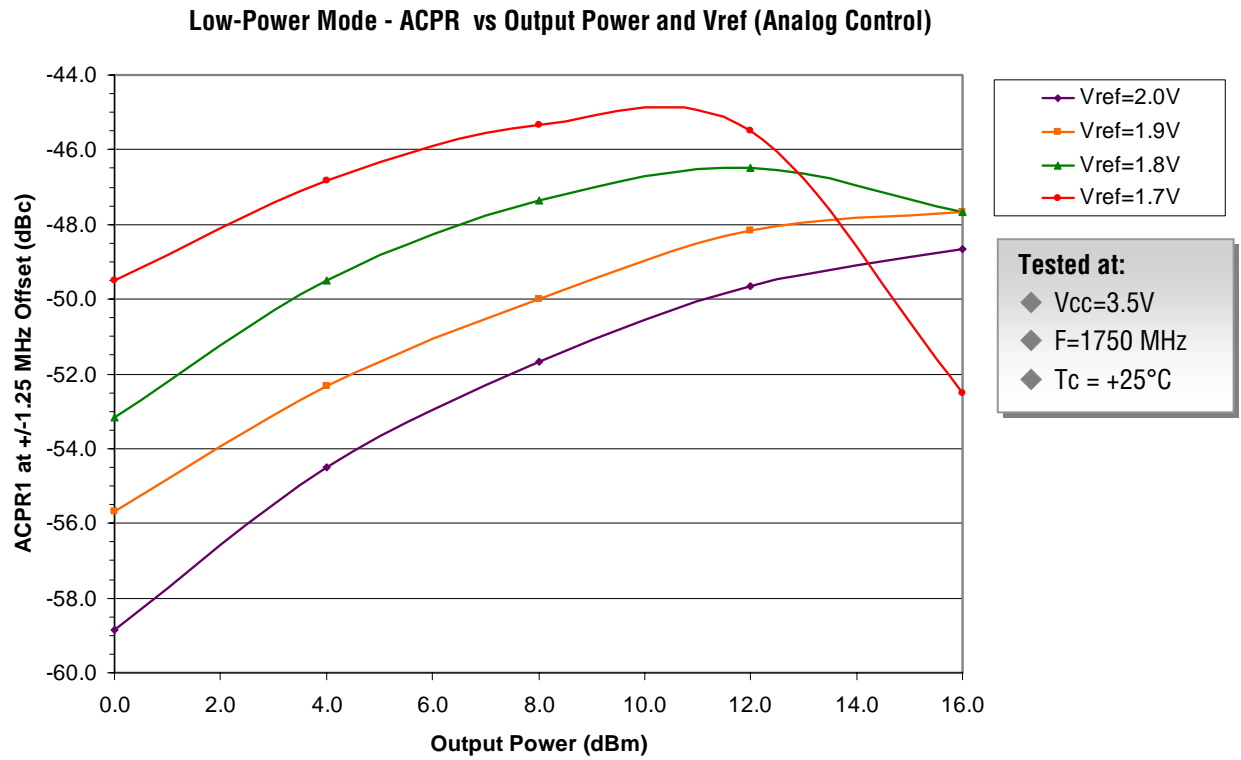
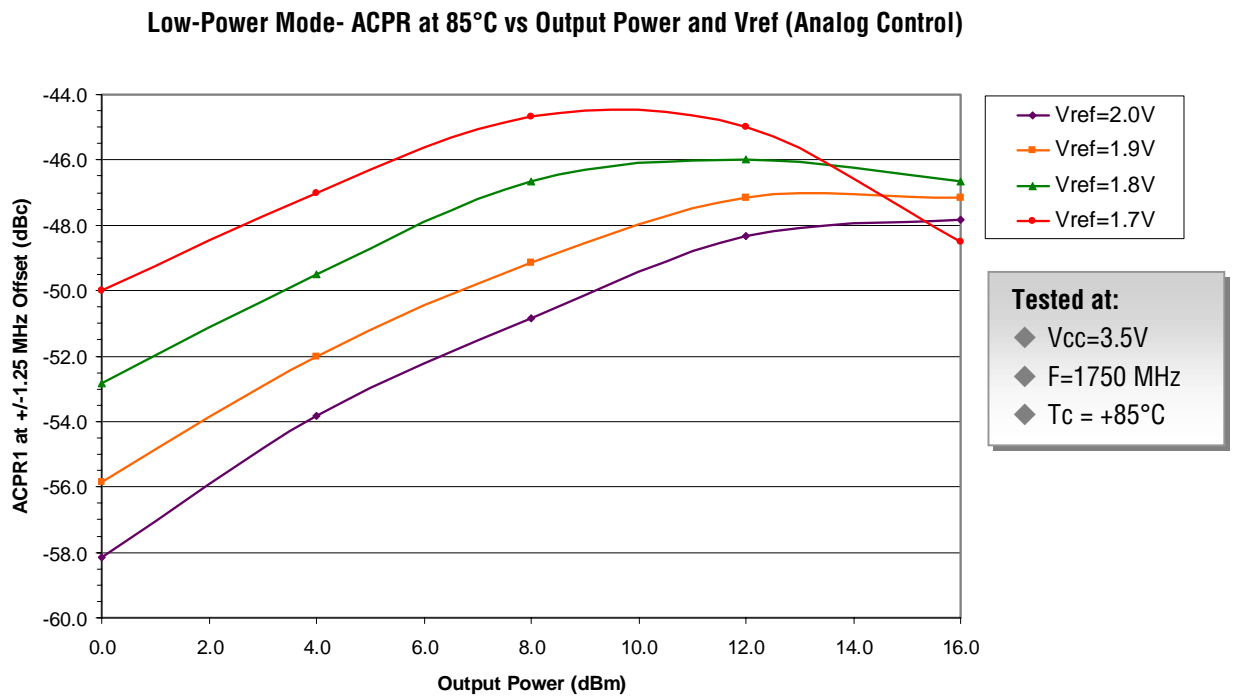

Figure 18



Characteristic performance data and specifications are subject to change without notice.

RMPA1751-102

3V PCS CDMA Power Amplifier Module

Figure 19

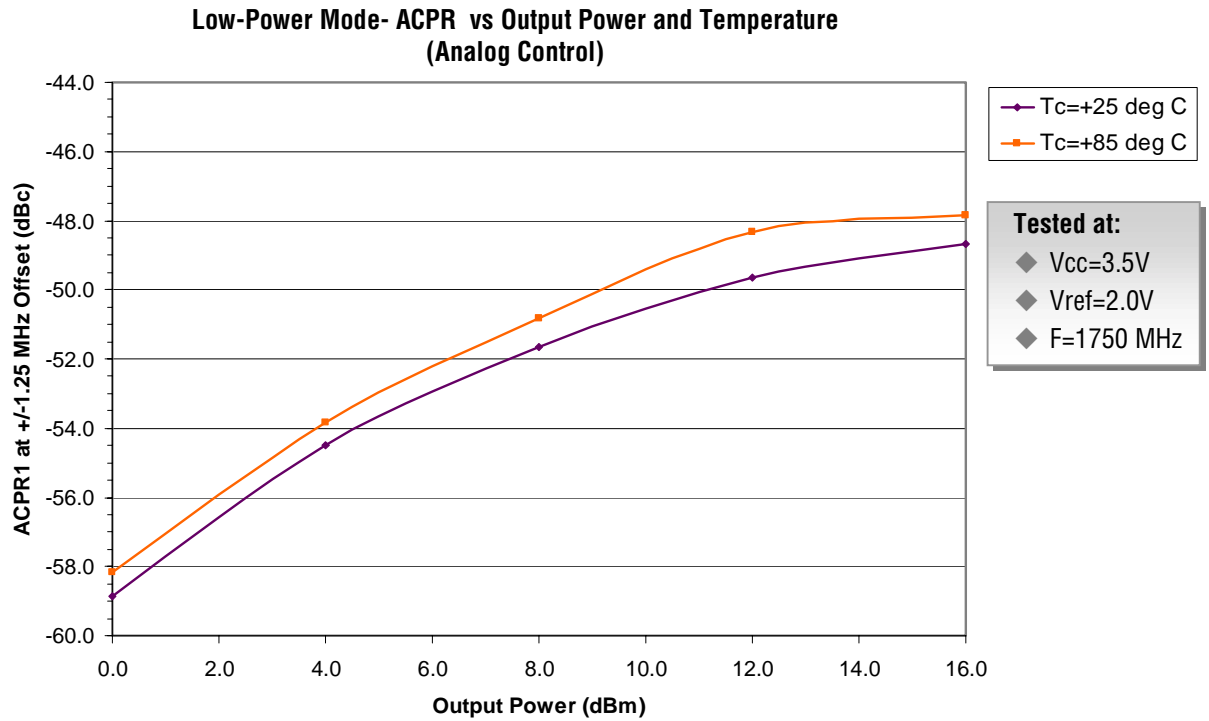
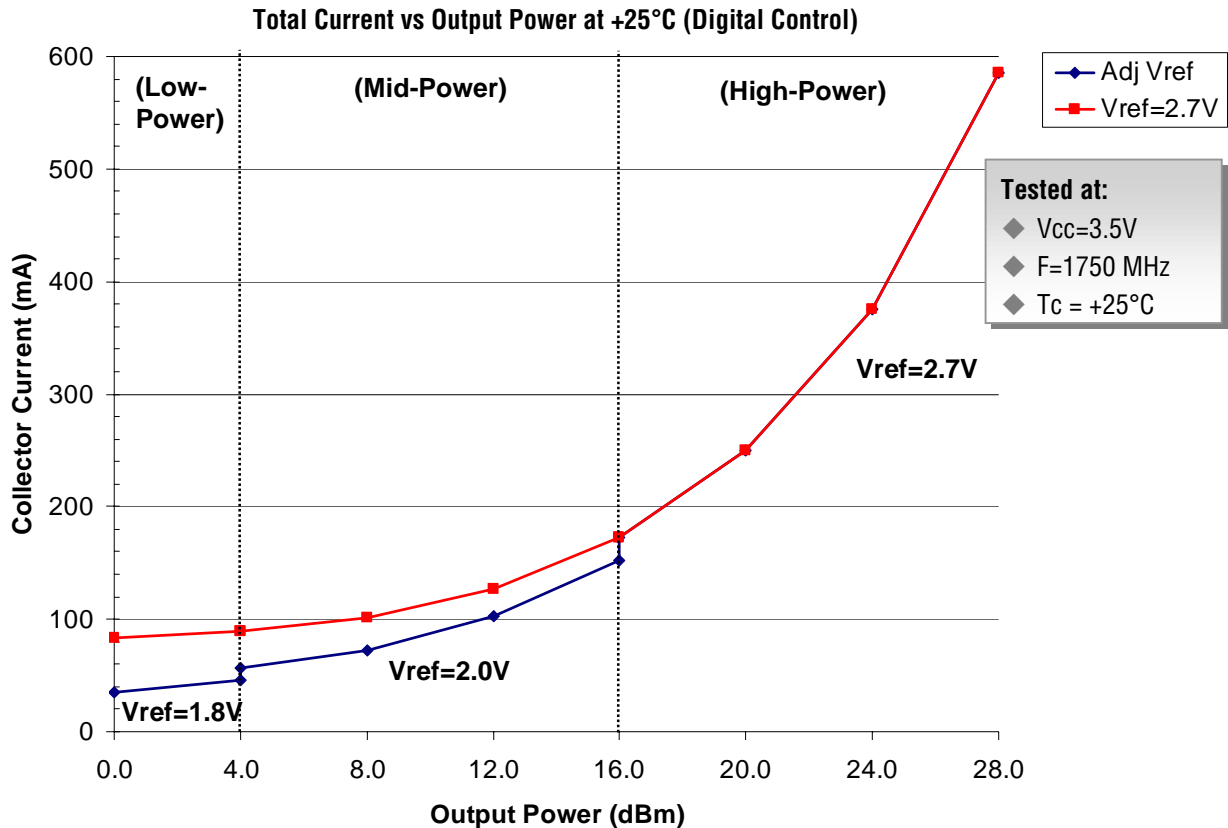

Figure 20



Characteristic performance data and specifications are subject to change without notice.

RMPA1751-102

3V PCS CDMA Power Amplifier Module

Figure 21

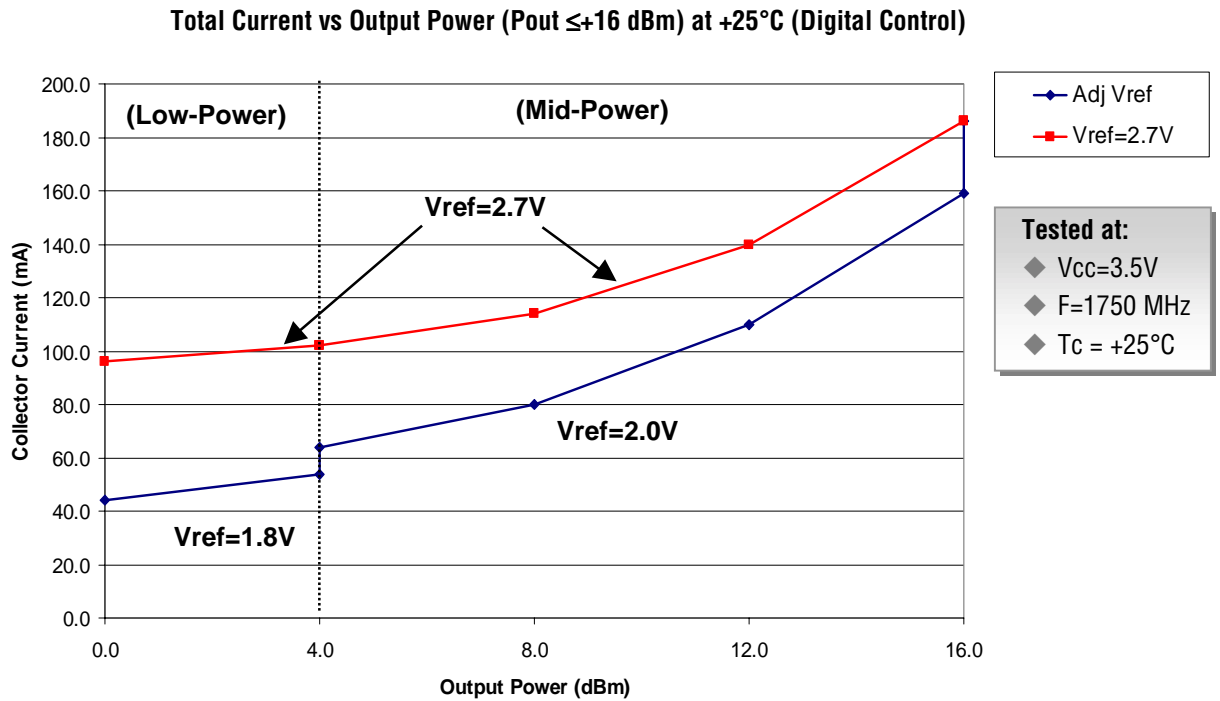
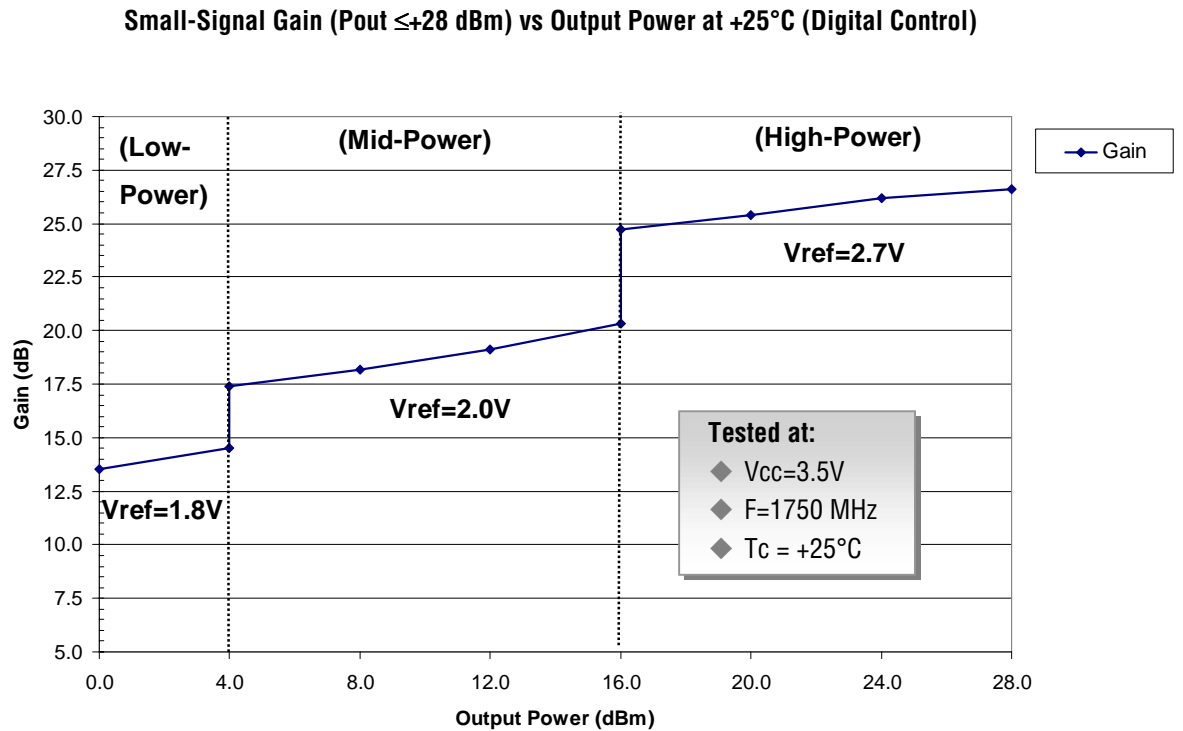

Figure 22



Characteristic performance data and specifications are subject to change without notice.

RMPA1751-102

3V PCS CDMA Power Amplifier Module

Figure 23

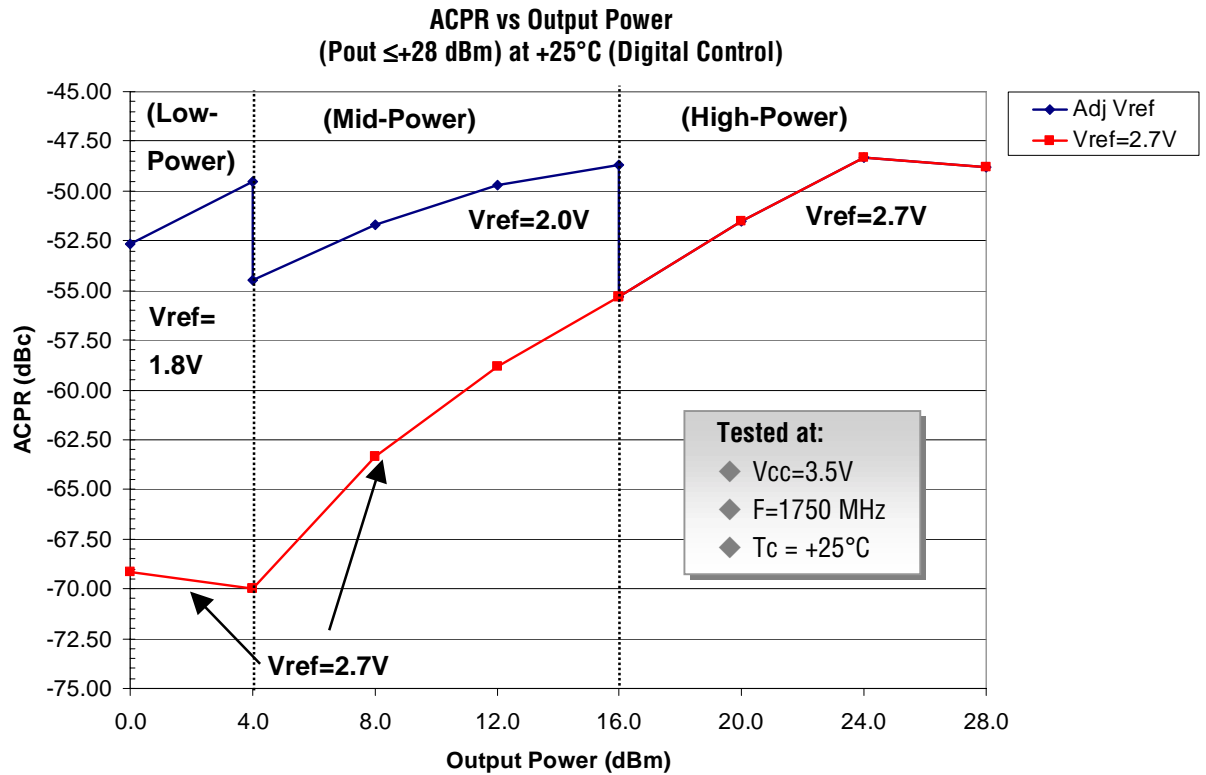
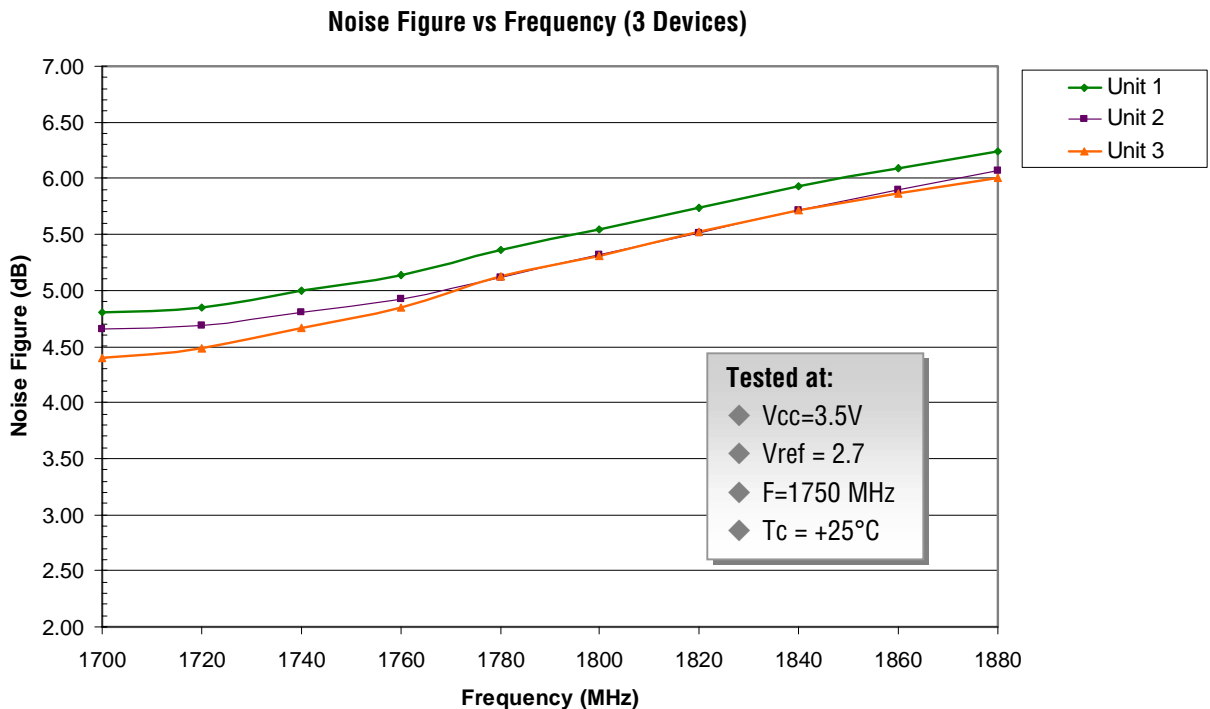

Figure 24



Characteristic performance data and specifications are subject to change without notice.

Worldwide Sales Representatives

North America

D&L Technical Sales
6139 S. Rural Road, #102
Tempe, AZ 85283
480-730-9553
fax: 480-730-9647
Nicholas Delvecchio, Jr.
dlarizona@aol.com

Hi-Peak Technical Sales
P.O. Box 6067
Amherst, NH 03031
866-230-5453
fax: 603-672-9228
sales@hi-peak.com

Spartech South
2115 Palm Bay Road, NE,
Suite 4
Palm Bay, FL 32904
321-727-8045
fax: 321-727-8086
Jim Morris
jim@spartech-south.com

TEQ Sales, Inc.
920 Davis Road, Suite 304
Elgin, IL 60123
847-742-3767
fax: 847-742-3947
Dennis Culpepper
dculpepper@teqsales.com

Cantec Representatives
8 Strathearn Ave, No. 18
Brampton, Ontario
Canada L6T 4L9
905-791-5922
fax: 905-791-7940
Dave Batten
cantec-ott@cantec-o.net

Steward Technology
6990 Village Pkwy #206
Dublin, CA 94568
925-833-7978
fax: 925-560-6522
John Steward
johnsteward1@msn.com

Europe

Sangus OY
Lunkintie 21,
90460 Oulunsalo
Finland
358-8-8251-100
fax: 358-8-8251-110
Juha Virtala
juha.virtala@sangus.fi

Sangus AB
Berghamnvgen 68
Box 5004
S-165 10 Hasselby
Sweden
Ronny Gustafson
468-0-380210
fax: 468-0-3720954

Globes Elektronik & Co.
Klarastrabe 12
74072 Heilbronn
Germany
49-7131-7810-0
fax: 49-7131-7810-20
Ulrich Blievernicht
hfwelt@globes.de

MTI Engineering Ltd.
Afeq Industrial Park
Hamelacha 11
New Industrial Area
Rosh Hayin 48091
Israel
972-3-902-5555
fax: 972-3-902-5556
Adi Peleg
adi_p@mti-group.co.il

Sirces srl
Via C. Boncompagni, 3B
20139 Milano
Italy
3902-57404785
fax: 3902-57409243
Nicola Iacovino
nicola.iacovino@sirces.it

Asia

ITX Corporation
2-5, Kasumigaseki
3-Chome
Chiyoda-Ku
Tokyo 100-6014 Japan
81-3-4288-7073
fax: 81-3-4288-7243
Maekawa Ryosuke
maekawa.ryosuke@
itx-corp.co.jp

Sea Union
9F-1, Building A, No 19-3
San-Chung Road
Nankang Software Park
Taiwan, ROC
Taipei 115
02-2655-3989
fax: 02-2655-3918
Murphy Su
murphy@seaunionweb.com.tw

Worldwide Distribution

Headquarters
6321 San Ignacio Drive
San Jose, CA 95119
408-360-4073
fax: 408-281-8802
Art Herbig
art.herbig@avnet.com

Belgium and Luxembourg
Cipalstraat
2440 GEEL
Belgium
32 14 570670
fax: 32 14 570679
sales.be@bfioptilas.avnet.com

United Kingdom
Burnt Ash Road
Aylesford, Kent
England
ME207XB
44 1622882467
fax: 44 1622882469
rfsales.uk@
bfioptilas.avnet.com

France
4 Allee du Cantal
Evry, Cedex
France
33 16079 5900
fax: 33 16079 8903
sales.fr@
bfioptilas.avnet.com

Holland
Chr. Huygensweg 17
2400 AJ ALPHEN AAN DEN
RIJN
The Netherlands
31 172 446060
fax: 33 172 443414
sales.nl@
bfioptilas.avnet.com

Spain
C/Isobel Colbrand, 6 – 4a
28050 Madrid
Spain
34 913588611
fax: 34 913589271
sales.es@
bfioptilas.avnet.com

Sales Office Headquarters

United States (East Coast)
Raytheon
362 Lowell Street
Andover, MA 01810
978-684-8628
fax: 978-684-8646
Walter Shelmet
wshelmet@
rrfc.raytheon.com

United States (West Coast)
Raytheon
362 Lowell Street
Andover, MA 01810
978-684-8919
fax: 978-684-8646
Rob Sinclair
robert_w_sinclair@
rrfc.raytheon.com

Europe
Raytheon
AM Teckenberg 53
40883 Ratingen
Germany
49-2102-706-155
fax: 49-2102-706-156
Peter Hales
peter_j_hales@
raytheon.com

Asia
Raytheon
Room 601, Gook Je Ctr. Bldg
191 Hangang Ro 2-GA
Yongsan-Gu, Seoul,
Korea 140-702
82-2-796-5797
fax: 82-2-796-5790
T.G. Lee
tg_lee@
rrfc.raytheon.com

Customer Support

978-684-8900

fax: 978-684-5452

customer_support@rrfc.raytheon.com