LOW VOLTAGE DETECTOR
RN5VS SERIES

APPLICATION MANUAL

RICOH

ELECTRONIC DEVICES DIVISION

NOTICE

1. The products and the product specifications described in this application manual are subject to change or discontinuation of production without notice for reasons such as improvement. Therefore, before deciding to use the products, please refer to Ricoh sales representatives for the latest information thereon.
2. This application manual may not be copied or otherwise reproduced in whole or in part without prior written consent of Ricoh.
3. Please be sure to take any necessary formalities under relevant laws or regulations before exporting or otherwise taking out of your country the products or the technical information described herein.
4. The technical information described in this application manual shows typical characteristics of and example application circuits for the products. The release of such information is not to be construed as a warranty of or a grant of license under Ricoh's or any third party's intellectual property rights or any other rights.
5. The products listed in this document are intended and designed for use as general electronic components in standard applications (office equipment, computer equipment, measuring instruments, consumer electronic products, amusement equipment etc.). Those customers intending to use a product in an application requiring extreme quality and reliability, for example, in a highly specific application where the failure or misoperation of the product could result in human injury or death (aircraft, spacevehicle, nuclear reactor control system, traffic control system, automotive and transportation equipment, combustion equipment, safety devices, life support system etc.) should first contact us.
6. We are making our continuous effort to improve the quality and reliability of our products, but semiconductor products are likely to fail with certain probability. In order prevent any injury to persons or damages to property resulting from such failure, customers should be careful enough to incorporate safety measures in their design, such as redundancy feature, fire-containment feature and fail-safe feature. We do not assume any liability or responsibility for any loss or damage arising from misuse or inappropriate use of the products.
7. Anti-radiation design is not implemented in the products described in this application manual.
8. Please contact Ricoh sales representatives should you have any questions or comments concerning the products or the technical information.

June 1995

RN5VS SERIES

APPLICATION MANUAL

CONTENTS

OUTLINE	1
FEATURES	1
APPLICATIONS	1
BLOCK DIAGRAMS	2
TIME CHART	2
DEFINITION OF OUTPUT DELAY TIME t_{plh}	2
SELECTION GUIDE	4
PIN CONFIGURATION	5
PIN DESCRIPTION	5
ABSOLUTE MAXIMUM RATINGS	6
ELECTRICAL CHARACTERISTICS	7
ELECTRICAL CHARACTERISTICS BY DETECTOR THRESHOLD	10
OPERATION	14
TEST CIRCUITS	15
TYPICAL CHARACTERISTICS	16
1) Supply Current vs. Input Voltage	16
2) Detector Threshold vs. Temperature	16
3) Output Voltage vs. Input Voltage	17
4) Nch Driver Output Current vs. V_{ds}	18
5) Nch Driver Output Current vs. Input Voltage	19
6) Pch Driver Output Current vs. Input Voltage	20
7) Output Delay Time vs. Load Capacitance	20
8) Output Delay Time vs. Input Pin Capacitance	21
TYPICAL APPLICATIONS	22
• RN5VSxxA CPU Reset Circuit(Nch Open Drain Output)	22
• RN5VSxxC CPU Reset Circuit(CMOS Output)	22
• RN5VSxxA Output delay Time Circuit 1	22
• RN5VSxxA Output delay Time Circuit 2	22
• Memory Back-up Circuit	22
• Voltage Level Indicator Circuit (lighted when the power runs out)	23
• Detector Threshold Changing Circuit	23
• Window Comparator Circuit	23
• Excessive Charge Preventing Circuit	23

PACKAGE DIMENSIONS	25
TAPING SPECIFICATIONS	25

RN5VS SERIES

OUTLINE

The RN5VS Series are voltage detector ICs with high detector threshold accuracy and ultra-low supply current by CMOS process, which can be operated at an extremely low voltage and is used, for instance, for system reset.

Each of these ICs consists of a voltage reference unit, a comparator, resistors for voltage detection, an output driver and a hysteresis circuit. The detector threshold is fixed with high accuracy.

The RN5VS Series are operable by a lower voltage than that for the R×5VL Series, and can be driven by a single battery.

Two output types, Nch open drain type and CMOS type, are available. Since the package for these ICs are SOT-23-5 (Mini-mold) package, high density mounting of the ICs on board is possible.

FEATURES

- Ultra-low Supply CurrentTYP. 0.8 μ A (VDD=1.5V)
- Broad Operating Voltage Range 0.7V to 10.0V (Topt =25°C)
- Detector Threshold.....Stepwise setting with a step of 0.1V in the range of 0.9V to 6.0V is possible (refer to Selection Guide).
- High Accuracy Detector Threshold..... \pm 3.0%
- Low Temperature-Drift Coefficient of Detector ThresholdTYP. \pm 100ppm/°C
- Two Output Types.....Nch Open Drain and CMOS
- Packages.....SOT-23-5 (Mini-mold)

APPLICATIONS

- CPU & Logic Circuit Reset
- Battery Checker
- Window Comparator
- Wave Shaping Circuit
- Battery Back-Up Circuit
- Power Failure Detector

BLOCK DIAGRAMS

• Nch Open Drain Output (RN5VS××A)

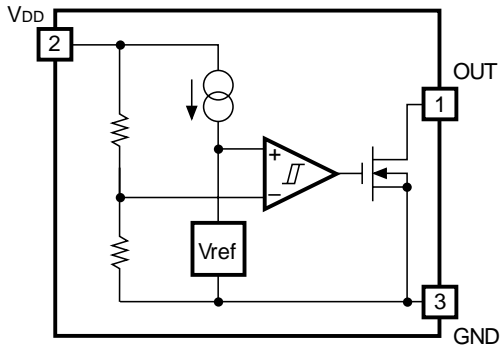

• CMOS Output (RN5VS××C)

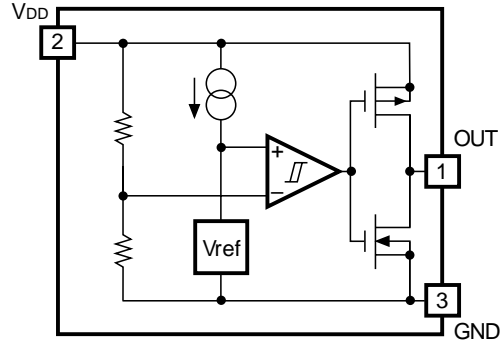

TIME CHART

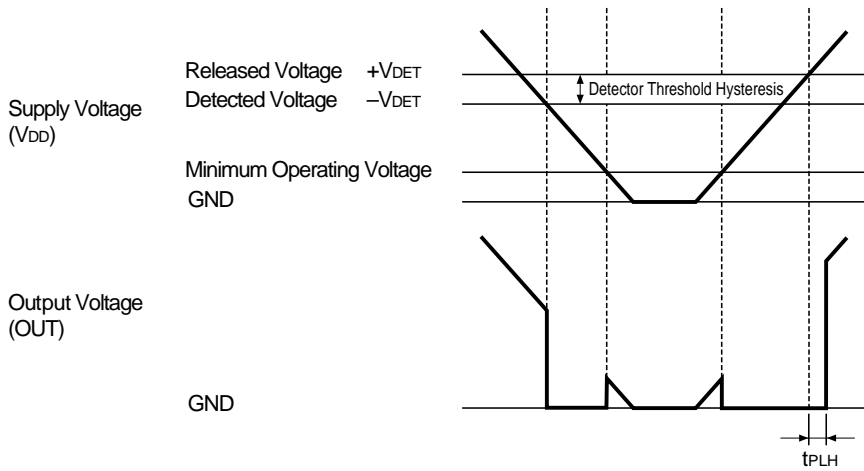

DEFINITION OF OUTPUT DELAY TIME t_{plh}

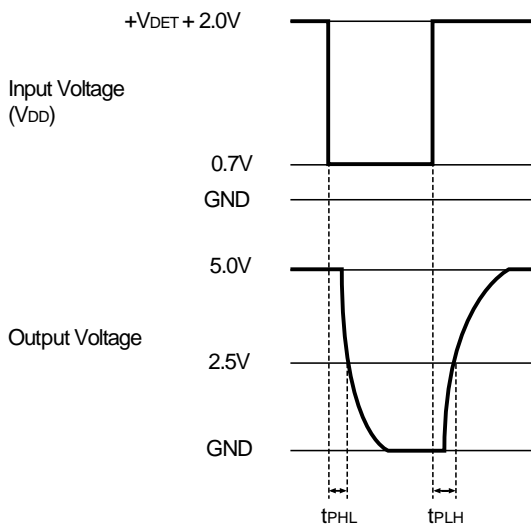

Nch Open Drain Output

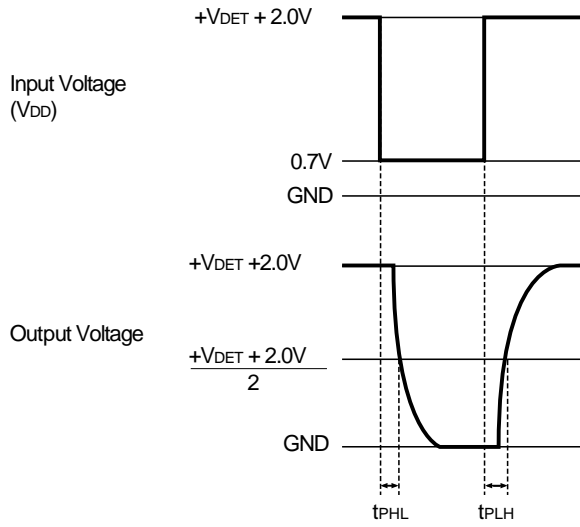

CMOS Output

Output Delay Time t_{PLH} is defined as follows:

1. In the case of Nch Open Drain Output:

When the time at which a pulse voltage which increases from 0.7V to $+V_{DET}+2.0V$ is applied to V_{DD} is Time A, and the time at which the output voltage reaches 2.5V under the conditions that the output pin (OUT) is pulled up to 5V by a resistor of 470k Ω is Time B, the time period from Time A through Time B.

2. In the case of CMOS Output:

When the time at which a pulse voltage which increases from 0.7V to $+V_{DET}+2.0V$ is applied to V_{DD} is Time A, and the time at which the output voltage reaches the voltage of $(+V_{DET}+2.0V)/2$ is Time B, the time period from Time A through Time B.

SELECTION GUIDE

The detector threshold, the output type, the packing type, and the taping type of RN5VS series can be designating at the user's request by specifying the part number as follows:

RN5VSXXXX-X → Part Number
 ↑ ↑ ↑ ↑
 a b c d

Code	Contents
a	Setting Detector Threshold ($-V_{DET}$): Stepwise setting with a step of 0.1V in the range of 0.9V to 6.0V is possible.
b	Designation of Output Type: A: Nch Open Drain C: CMOS
c	Designation of Packing Type: A: Taping C: Antistatic bag for samples
d	Designation of Taping Type: Ex. TR, TL (refer to Taping Specifications, the standard direction is TR.)

For example, the product with Detector Threshold 3.5V, Output Type Nch Open Drain and Taping Type TR, is designated by Part Number RN5VS35AA-TR.

PIN CONFIGURATION

• SOT-23-5

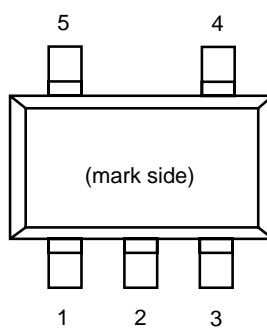

PIN DESCRIPTION

• SOT-23-5

Pin No.	Symbol
1	OUT
2	V _{DD}
3	GND
4	NC
5	NC

ABSOLUTE MAXIMUM RATINGST_{opt}=25°C

Symbol	Item	Rating		Unit
V _{DD}	Supply Voltage	+12		V
V _{OUT}	Output Voltage	CMOS	V _{SS} -0.3 to V _{DD} +0.3	V
		Nch	V _{SS} -0.3 to +12	
I _{OUT}	Output Current	70		mA
P _D	Power Dissipation	150		mW
T _{opt}	Operating Temperature Range	-40 to +85		°C
T _{stg}	Storage Temperature Range	-55 to +125		°C
T _{solder}	Lead Temperature (Soldering)	260°C, 10s		

ABSOLUTE MAXIMUM RATINGS

Absolute Maximum ratings are threshold limit values that must not be exceeded even for an instant under any conditions. Moreover, such values for any two items must not be reached simultaneously. Operation above these absolute maximum ratings may cause degradation or permanent damage to the device. These are stress ratings only and do not necessarily imply functional operation below these limits.

ELECTRICAL CHARACTERISTICS

• RN5VS09A/C

T_{opt}=25°C

Symbol	Item	Conditions	MIN.	TYP.	MAX.	Unit	Note
-V _{DET}	Detector Threshold		0.873	0.900	0.927	V	
V _{HYS}	Detector Threshold Hysteresis		0.018	0.045	0.072	V	
I _{SS}	Supply Current	V _{DD} =0.80V		0.8	2.4	μA	
		V _{DD} =2.90V		0.9	2.7		
V _{DDH}	Maximum Operating Voltage				10	V	
V _{DDL}	Minimum Operating Voltage	T _{opt} =25°C		0.55	0.70	V	Note 1
		-40°C≤T _{opt} ≤85°C		0.65	0.80		
I _{OUT}	Output Current	Nch	V _{DS} =0.05V, V _{DD} =0.70V	0.01	0.05	mA	
			V _{DS} =0.50V, V _{DD} =0.85V	0.05	0.50		
		Pch	V _{DS} =-2.1V, V _{DD} =4.5V	1.0	2.0	mA	
t _{PLH}	Output Delay Time				100	μs	Note 2
$\frac{\Delta-V_{DET}}{\Delta T_{opt}}$	Detector Threshold Temperature Coefficient	-40°C≤T _{opt} ≤85°C		±100		ppm/°C	

• RN5VS18A/C

T_{opt}=25°C

Symbol	Item	Conditions	MIN.	TYP.	MAX.	Unit	Note
-V _{DET}	Detector Threshold		1.746	1.800	1.854	V	
V _{HYS}	Detector Threshold Hysteresis		0.036	0.090	0.144	V	
I _{SS}	Supply Current	V _{DD} =1.70V		0.8	2.4	μA	
		V _{DD} =3.80V		1.0	3.0		
V _{DDH}	Maximum Operating Voltage				10	V	
V _{DDL}	Minimum Operating Voltage	T _{opt} =25°C		0.55	0.70	V	Note 1
		-40°C≤T _{opt} ≤85°C		0.65	0.80		
I _{OUT}	Output Current	Nch	V _{DS} =0.05V, V _{DD} =0.70V	0.01	0.05	mA	
			V _{DS} =0.50V, V _{DD} =1.50V	1.00	2.00		
		Pch	V _{DS} =-2.1V, V _{DD} =4.5V	1.0	2.0	mA	
t _{PLH}	Output Delay Time				100	μs	Note 2
$\frac{\Delta-V_{DET}}{\Delta T_{opt}}$	Detector Threshold Temperature Coefficient	-40°C≤T _{opt} ≤85°C		±100		ppm/°C	

RN5VS

• RN5VS27A/C

T_{opt}=25°C

Symbol	Item	Conditions	MIN.	TYP.	MAX.	Unit	Note
-V _{DET}	Detector Threshold		2.619	2.700	2.781	V	
V _{HYS}	Detector Threshold Hysteresis		0.054	0.135	0.216	V	
I _{SS}	Supply Current	V _{DD} =2.60V		0.9	2.7	μA	
		V _{DD} =4.70V		1.1	3.3		
V _{DDH}	Maximum Operating Voltage				10	V	
V _{DDL}	Minimum Operating Voltage	T _{opt} =25°C		0.55	0.70	V	Note 1
		-40°C≤T _{opt} ≤85°C		0.65	0.80		
I _{OUT}	Output Current	Nch	V _{DS} =0.05V, V _{DD} =0.70V	0.01	0.05		mA
			V _{DS} =0.50V, V _{DD} =1.50V	1.00	2.00		
		Pch	V _{DS} =-2.1V, V _{DD} =4.5V	1.0	2.0		mA
t _{PLH}	Output Delay Time				100	μs	Note 2
$\frac{\Delta-V_{DET}}{\Delta T_{opt}}$	Detector Threshold Temperature Coefficient	-40°C≤T _{opt} ≤85°C		±100		ppm/°C	

• RN5VS36A/C

T_{opt}=25°C

Symbol	Item	Conditions	MIN.	TYP.	MAX.	Unit	Note
-V _{DET}	Detector Threshold		3.492	3.600	3.708	V	
V _{HYS}	Detector Threshold Hysteresis		0.072	0.180	0.288	V	
I _{SS}	Supply Current	V _{DD} =3.47V		1.0	3.0	μA	
		V _{DD} =5.60V		1.2	3.6		
V _{DDH}	Maximum Operating Voltage				10	V	
V _{DDL}	Minimum Operating Voltage	T _{opt} =25°C		0.55	0.70	V	Note 1
		-40°C≤T _{opt} ≤85°C		0.65	0.80		
I _{OUT}	Output Current	Nch	V _{DS} =0.05V, V _{DD} =0.70V	0.01	0.05		mA
			V _{DS} =0.50V, V _{DD} =1.50V	1.00	2.00		
		Pch	V _{DS} =-2.1V, V _{DD} =4.5V	1.0	2.0		mA
t _{PLH}	Output Delay Time				100	μs	Note 2
$\frac{\Delta-V_{DET}}{\Delta T_{opt}}$	Detector Threshold Temperature Coefficient	-40°C≤T _{opt} ≤85°C		±100		ppm/°C	

• RN5VS45A/C

Topt=25°C

Symbol	Item	Conditions	MIN.	TYP.	MAX.	Unit	Note
-VDET	Detector Threshold		4.365	4.500	4.635	V	
VHYS	Detector Threshold Hysteresis		0.090	0.225	0.360	V	
ISS	Supply Current	VDD=4.34V		1.1	3.3	μA	
		VDD=6.50V		1.3	3.9		
VDDH	Maximum Operating Voltage				10	V	
VDDL	Minimum Operating Voltage	Topt=25°C		0.55	0.70	V	Note 1
		-40°C≤Topt≤85°C		0.65	0.80		
IOUT	Output Current	Nch	VDS=0.05V, VDD=0.70V	0.01	0.05	mA	
			VDS=0.50V, VDD=1.50V	1.00	2.00		
		Pch	VDS=-2.1V, VDD=8.0V	1.5	3.0	mA	
tPLH	Output Delay Time				100	μs	Note 2
$\frac{\Delta-V_{DET}}{\Delta T_{opt}}$	Detector Threshold Temperature Coefficient	-40°C≤Topt≤85°C		±100		ppm/°C	

• RN5VS54A/C

Topt=25°C

Symbol	Item	Conditions	MIN.	TYP.	MAX.	Unit	Note
-VDET	Detector Threshold		5.238	5.400	5.562	V	
VHYS	Detector Threshold Hysteresis		0.108	0.270	0.432	V	
ISS	Supply Current	VDD=5.20V		1.2	3.6	μA	
		VDD=7.40V		1.4	4.2		
VDDH	Maximum Operating Voltage				10	V	
VDDL	Minimum Operating Voltage	Topt=25°C		0.55	0.70	V	Note 1
		-40°C≤Topt≤85°C		0.65	0.80		
IOUT	Output Current	Nch	VDS=0.05V, VDD=0.70V	0.01	0.05	mA	
			VDS=0.50V, VDD=1.50V	1.00	2.00		
		Pch	VDS=-2.1V, VDD=8.0V	1.5	3.0	mA	
tPLH	Output Delay Time				100	μs	Note 2
$\frac{\Delta-V_{DET}}{\Delta T_{opt}}$	Detector Threshold Temperature Coefficient	-40°C≤Topt≤85°C		±100		ppm/°C	

(Note 1) Minimum Operating Voltage means the value of input voltage when output voltage maintains 0.1V or less, provided that in the case of Nch Open Drain Type Products, the pull-up resistance is set at 470kΩ, and the pull-up voltage is set at 5.0V.

(Note 2) Refer to the previously defined "Output Delay Time tPLH".

ELECTRICAL CHARACTERISTICS BY DETECTOR THRESHOLD

• RN5VS09A/C to RN5VS39A/C

Part Number	Detector Threshold			Detector Threshold Hysteresis			Supply Current 1			Supply Current 2		
	-Vdet(V)			Vhys(V)			Iss(μA)			Iss(μA)		
	MIN.	TYP.	MAX.	MIN.	TYP.	MAX.	Conditions	TYP.	MAX.	Conditions	TYP.	MAX.
RN5VS09A/C	0.873	0.900	0.927	0.018	0.045	0.072	V _{DD} = (-V _{DET}) -0.10V	0.8	2.4	V _{DD} = (-V _{DET}) +2.0V	0.9	2.7
RN5VS10A/C	0.970	1.000	1.030	0.020	0.050	0.080					1.0	3.0
RN5VS11A/C	1.067	1.100	1.133	0.022	0.055	0.088					1.0	3.0
RN5VS12A/C	1.164	1.200	1.236	0.024	0.060	0.096					1.0	3.0
RN5VS13A/C	1.261	1.300	1.339	0.026	0.065	0.104					1.0	3.0
RN5VS14A/C	1.358	1.400	1.442	0.028	0.070	0.112					1.0	3.0
RN5VS15A/C	1.455	1.500	1.545	0.030	0.075	0.120					1.0	3.0
RN5VS16A/C	1.552	1.600	1.648	0.032	0.080	0.128					1.0	3.0
RN5VS17A/C	1.649	1.700	1.751	0.034	0.085	0.136					1.0	3.0
RN5VS18A/C	1.746	1.800	1.854	0.036	0.090	0.144					1.0	3.0
RN5VS19A/C	1.843	1.900	1.957	0.038	0.095	0.152					1.0	3.0
RN5VS20A/C	1.940	2.000	2.060	0.040	0.100	0.160					1.0	3.0
RN5VS21A/C	2.037	2.100	2.163	0.042	0.105	0.168					1.0	3.0
RN5VS22A/C	2.134	2.200	2.266	0.044	0.110	0.176					1.0	3.0
RN5VS23A/C	2.231	2.300	2.369	0.046	0.115	0.184					1.0	3.0
RN5VS24A/C	2.328	2.400	2.472	0.048	0.120	0.192	1.0	3.0				
RN5VS25A/C	2.425	2.500	2.575	0.050	0.125	0.200	1.0	3.0				
RN5VS26A/C	2.522	2.600	2.678	0.052	0.130	0.208	1.0	3.0				
RN5VS27A/C	2.619	2.700	2.781	0.054	0.135	0.216	1.0	3.0				
RN5VS28A/C	2.716	2.800	2.884	0.056	0.140	0.224	1.0	3.0				
RN5VS29A/C	2.813	2.900	2.987	0.058	0.145	0.232	1.0	3.0				
RN5VS30A/C	2.910	3.000	3.090	0.060	0.150	0.240	1.0	3.0				
RN5VS31A/C	3.007	3.100	3.193	0.062	0.155	0.248	1.0	3.0				
RN5VS32A/C	3.104	3.200	3.296	0.064	0.160	0.256	1.0	3.0				
RN5VS33A/C	3.201	3.300	3.399	0.066	0.165	0.264	1.0	3.0				
RN5VS34A/C	3.298	3.400	3.502	0.068	0.170	0.272	1.0	3.0				
RN5VS35A/C	3.395	3.500	3.605	0.070	0.175	0.280	1.0	3.0				
RN5VS36A/C	3.492	3.600	3.708	0.072	0.180	0.288	1.0	3.0				
RN5VS37A/C	3.589	3.700	3.811	0.074	0.185	0.296	1.0	3.0				
RN5VS38A/C	3.686	3.800	3.914	0.076	0.190	0.304	1.0	3.0				
RN5VS39A/C	3.783	3.900	4.017	0.078	0.195	0.312	1.0	3.0				

(Note 1) Refer to the previously defined "Output Delay Time t_{PLH}".

(Note 2) Refer to the previously defined "Minimum Operating Voltage".

Condition 1 : T_{opt} = 25°CCondition 2 : -40°C ≤ T_{opt} ≤ 85°C

RN5VS

• RN5VS40A/C to RN5VS60A/C

Part Number	Detector Threshold			Detector Threshold Hysteresis			Supply Current 1			Supply Current 2		
	-Vdet(V)			Vhys(V)			Iss(μA)			Iss(μA)		
	MIN.	TYP.	MAX.	MIN.	TYP.	MAX.	Conditions	TYP.	MAX.	Conditions	TYP.	MAX.
RN5VS40A/C	3.880	4.000	4.120	0.080	0.200	0.320	VDD= (-VDET) -0.16V	1.1	3.3	VDD= (-VDET) +2.0V	1.3	3.9
RN5VS41A/C	3.977	4.100	4.223	0.082	0.205	0.328						
RN5VS42A/C	4.074	4.200	4.326	0.084	0.210	0.336						
RN5VS43A/C	4.171	4.300	4.429	0.086	0.215	0.344						
RN5VS44A/C	4.268	4.400	4.532	0.088	0.220	0.352						
RN5VS45A/C	4.365	4.500	4.635	0.090	0.225	0.360						
RN5VS46A/C	4.462	4.600	4.738	0.092	0.230	0.368						
RN5VS47A/C	4.559	4.700	4.841	0.094	0.235	0.376						
RN5VS48A/C	4.656	4.800	4.944	0.096	0.240	0.384						
RN5VS49A/C	4.753	4.900	5.047	0.098	0.245	0.392	VDD= (-VDET) -0.20V	1.2	3.6	1.4	4.2	
RN5VS50A/C	4.850	5.000	5.150	0.100	0.250	0.400						
RN5VS51A/C	4.947	5.100	5.253	0.102	0.255	0.408						
RN5VS52A/C	5.044	5.200	5.356	0.104	0.260	0.416						
RN5VS53A/C	5.141	5.300	5.459	0.106	0.265	0.424						
RN5VS54A/C	5.238	5.400	5.562	0.108	0.270	0.432						
RN5VS55A/C	5.335	5.500	5.665	0.110	0.275	0.440						
RN5VS56A/C	5.432	5.600	5.768	0.112	0.280	0.448						
RN5VS57A/C	5.529	5.700	5.871	0.114	0.285	0.456						
RN5VS58A/C	5.626	5.800	5.974	0.116	0.290	0.464						
RN5VS59A/C	5.723	5.900	6.077	0.118	0.295	0.472						
RN5VS60A/C	5.820	6.000	6.180	0.120	0.300	0.480						

(Note 1) Refer to the previously defined "Output Delay Time t_{PLH}".

(Note 2) Refer to the previously defined "Minimum Operating Voltage".

Condition 1 : T_{opt} = 25°C

Condition 2 : -40°C ≤ T_{opt} ≤ 85°C

Topt=25°C

Output Current 1			Output Current 2			Output Current 3			Output Delay Time	Minimum Operating Voltage		Detector Threshold Tempco.		
Iout(mA)			Iout(mA)			Iout(mA)			tph(μs)	Vddl(V)		Δ-Vdet/ΔTopt (ppm/°C)		
Conditions	MIN.	TYP.	Conditions	MIN.	TYP.	Conditions	MIN.	TYP.	MAX.	TYP.	MAX.	Conditions	TYP.	
Nch						Pch				Note 2	Note 2			
VDS= 0.05V	0.01	0.05	VDS= 0.50V	VDD= 1.5V	1.0	2.0	VDS= -2.1V	1.5	3.0	Note 1 100	Condition 1 0.55	Condition 1 0.70	-40°C ≤ Topt ≤85°C	±100
VDD= 0.7V							VDD= 8.0V				Condition 2 0.65	Condition 2 0.80		

OPERATION

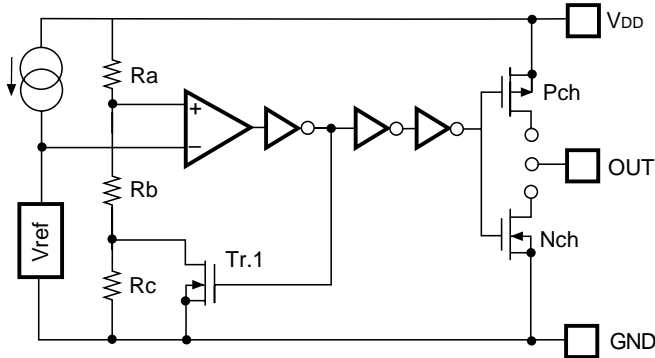

FIG. 1 Block Diagram

- In RN5VS××A, Nch Tr. drain is connected to OUT pin.
- In RN5VS××C, Nch Tr. drain and Pch Tr. drain are connected to OUT pin.

Operation Diagram

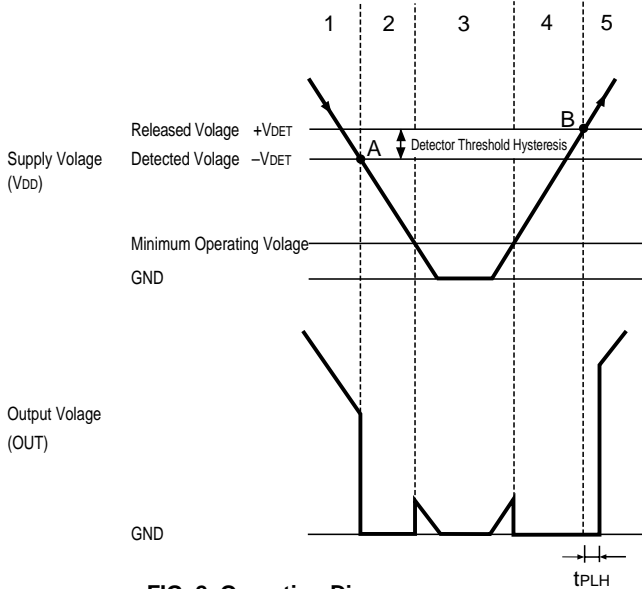

FIG. 2 Operation Diagram

Step	Step 1	Step 2	Step 3	Step 4	Step 5
Comparator(+) Pin Input Voltage	I	II	II	II	I
Comparator Output	H	L	Indefinite	L	H
Tr. 1	OFF	ON	Indefinite	ON	OFF
Output Tr.	Pch	ON	OFF	OFF	ON
	Nch	OFF	ON	Indefinite	ON

$$I. \frac{Rb + Rc}{Ra + Rb + Rc} \cdot V_{DD}$$

$$II. \frac{Rb}{Ra + Rb} \cdot V_{DD}$$

- Step 1. Output Voltage is equal to Power Source Voltage (V_{DD}).
- Step 2. When Input Voltage to Comparator reaches the state of $V_{ref} \geq V_{DD} \cdot (Rb + Rc) / (Ra + Rb + Rc)$ at Point A (Detected Voltage $-V_{DET}$), the output of Comparator is reserved, so that Output Voltage becomes GND.
- Step 3. In the case of CMOS Output, Output Voltage becomes unstable when Supply Voltage (V_{DD}) is smaller than Minimum Operating Voltage. In the case of Nch Open Drain Output, a pulled-up voltage is output.
- Step 4. Output Voltage becomes equal to GND.
- Step 5. When Input Voltage to Comparator reaches the state of $V_{ref} \leq V_{DD} \cdot (Rb) / (Ra + Rb)$ at Point B (Released Voltage $+V_{DET}$), the output of Comparator is reversed, so that Output Voltage becomes equal to Supply Voltage (V_{DD}).

TEST CIRCUITS

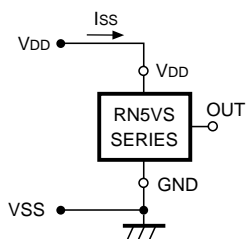

FIG. 3 Supply Current Test Circuit

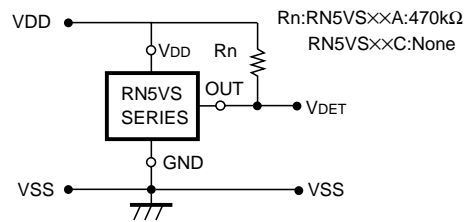

FIG. 4 Detector Threshold Test Circuit

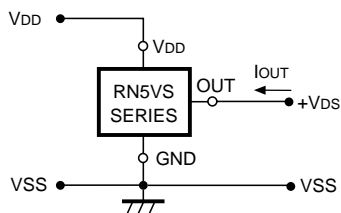

FIG. 5 Nch Driver Output Current Test Circuit

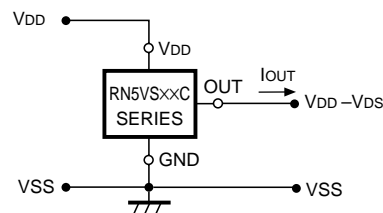

FIG. 6 Pch Driver Output Current Test Circuit

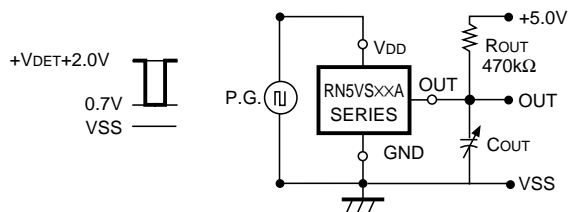

FIG. 7 Output Delay Time Test Circuit (1)

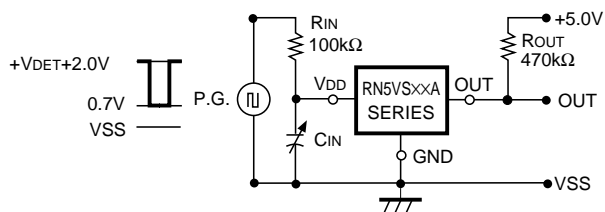
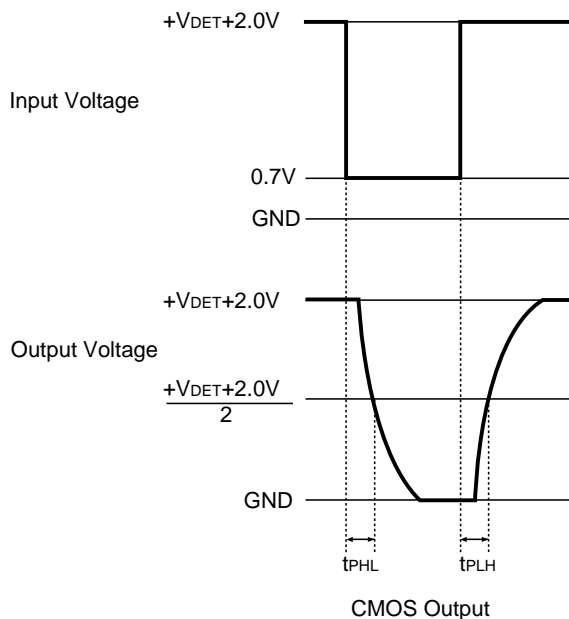
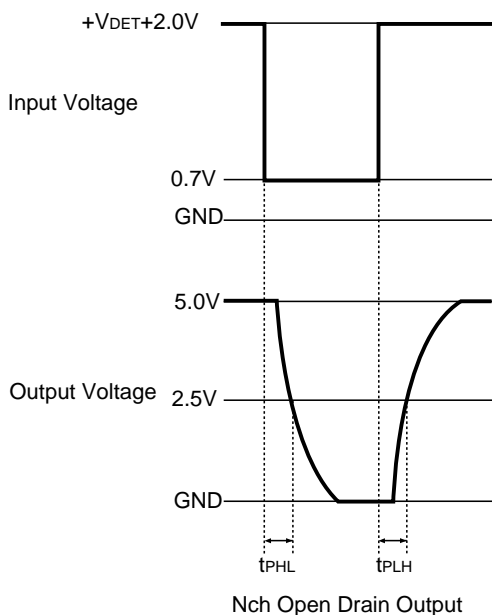

FIG. 8 Output Delay Time Test Circuit (2)

In Output Delay Time Test Circuits (1) and (2) in FIG. 7 and FIG. 8, their respective Output Voltage Fall Times (t_{PHL}) and Rise Times (t_{PLH}) are defined as shown below.



TYPICAL CHARACTERISTICS

1) Supply Current vs. Input Voltage

RN5VS09C

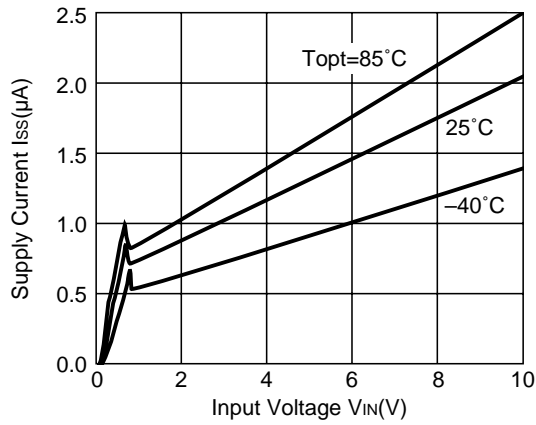

RN5VS27C

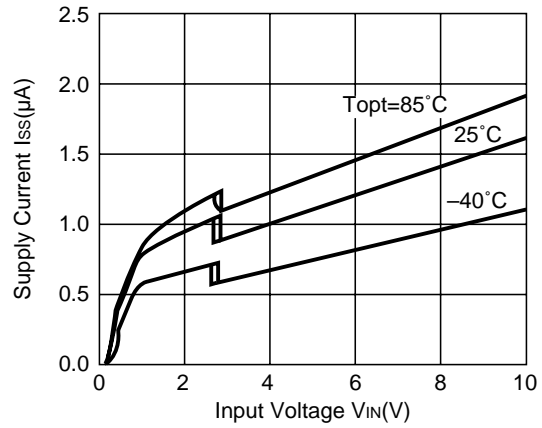

RN5VS45C

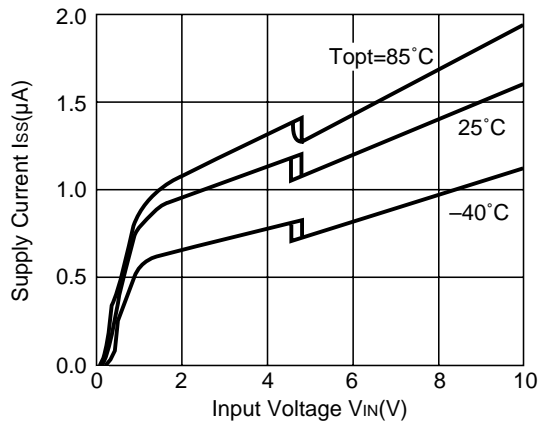

2) Detector Threshold vs. Temperature

RN5VS09C

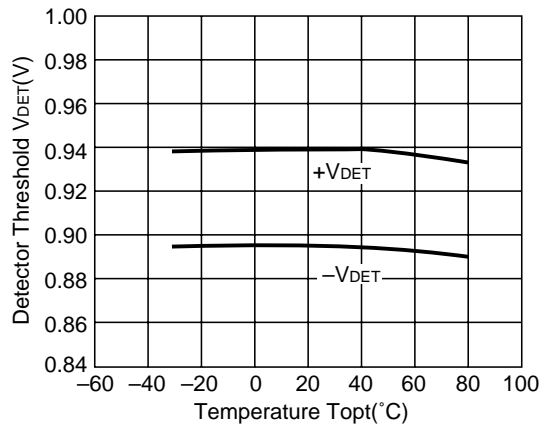

RN5VS27C

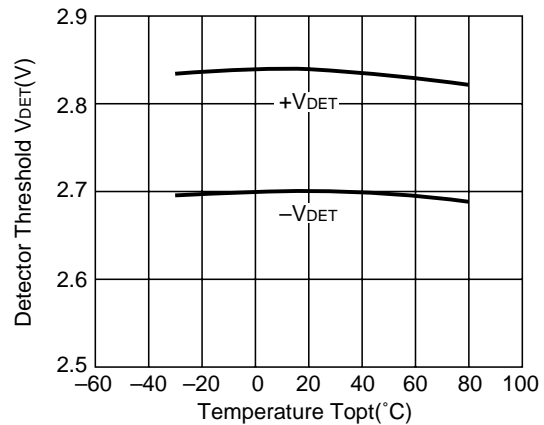

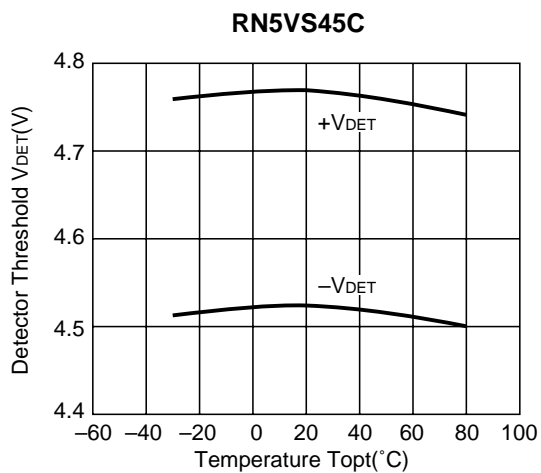

3) Output Voltage vs. Input Voltage

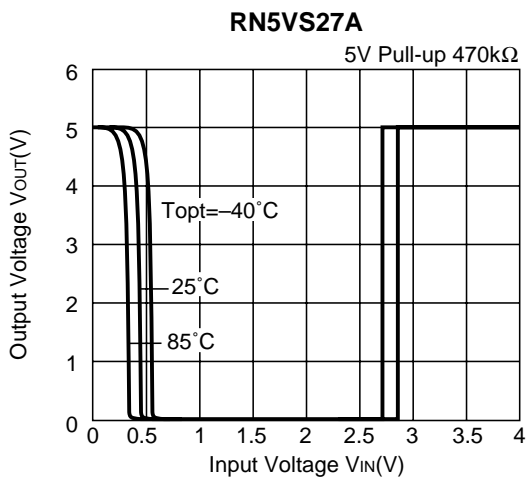
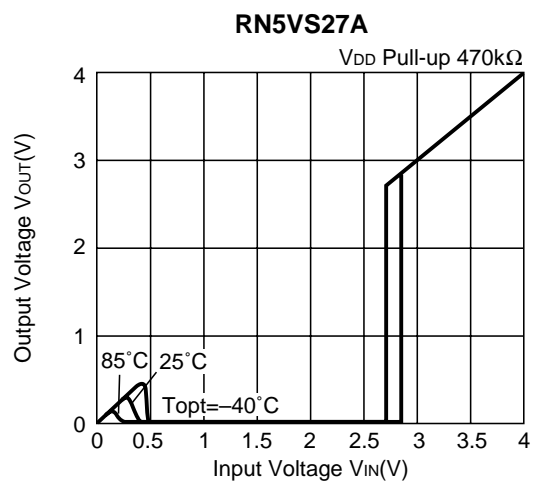
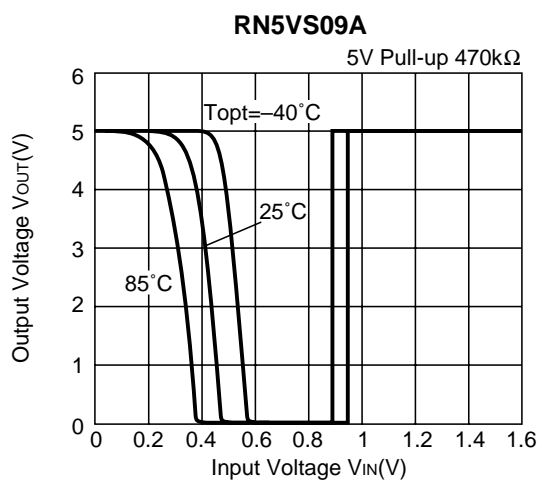
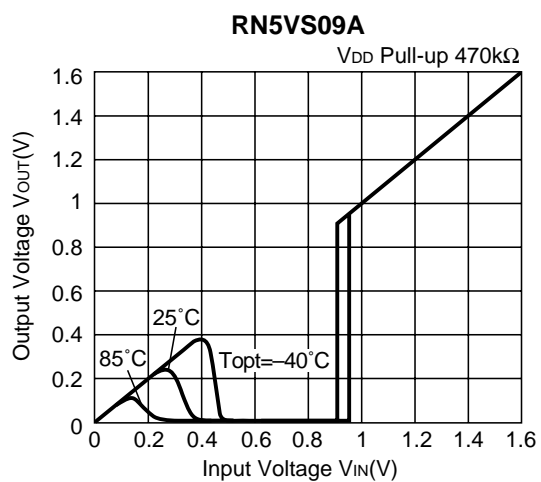

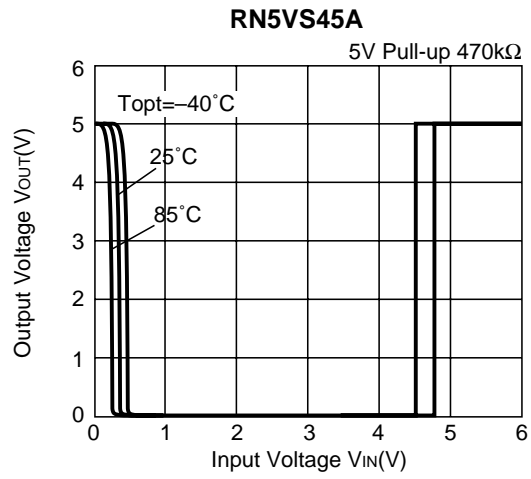
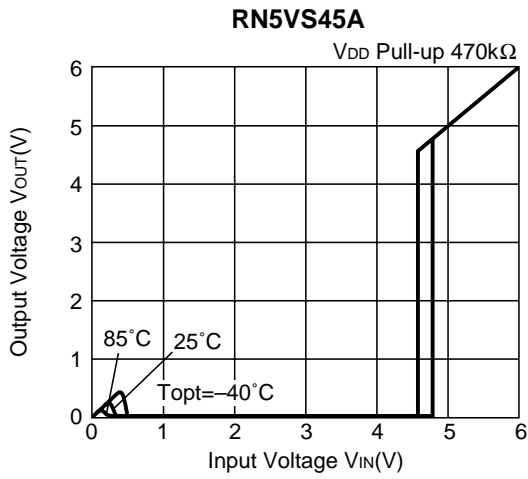

4) Nch Driver Output Current vs. V_{DS}

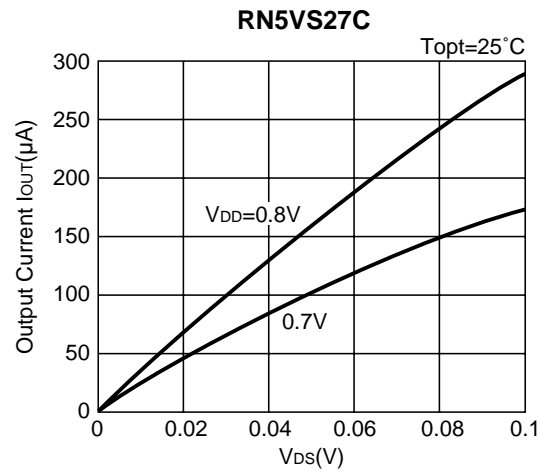
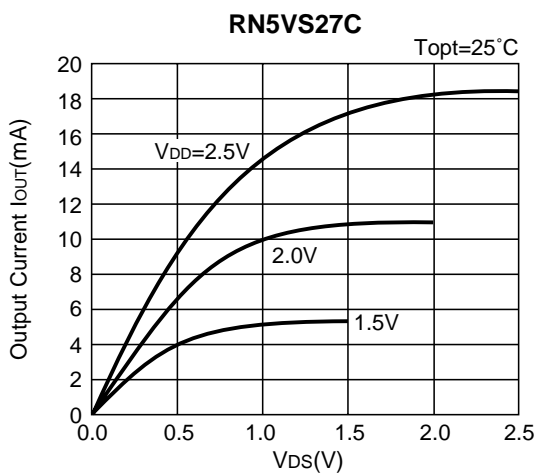
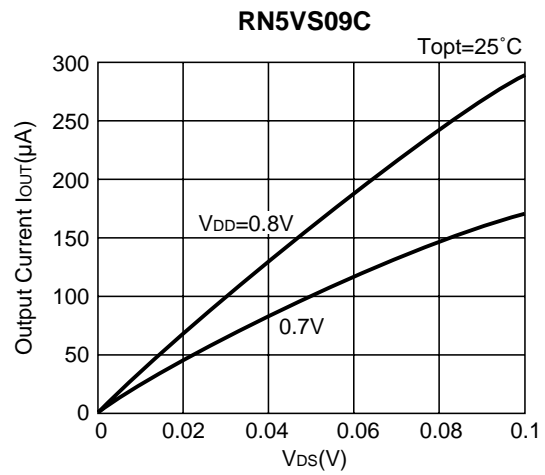
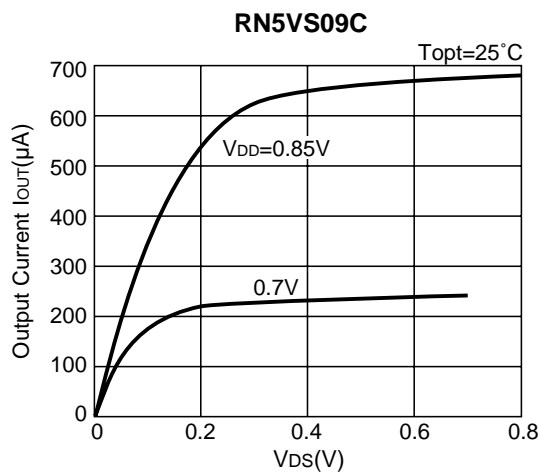

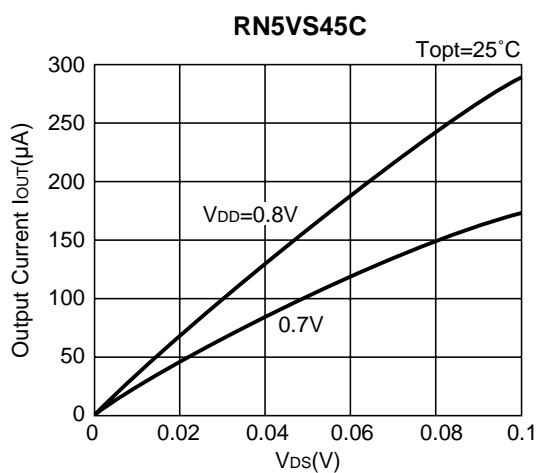
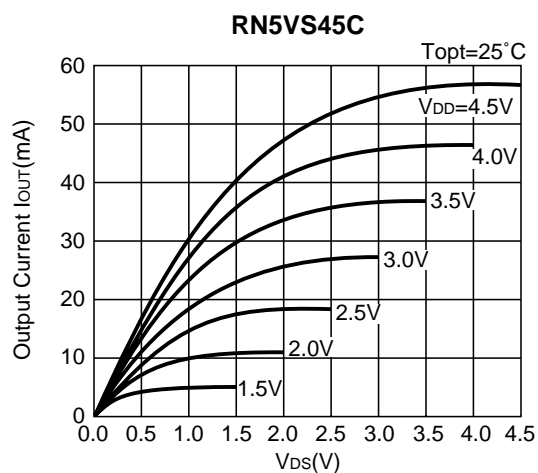

5) Nch Driver Output Current vs. Input Voltage

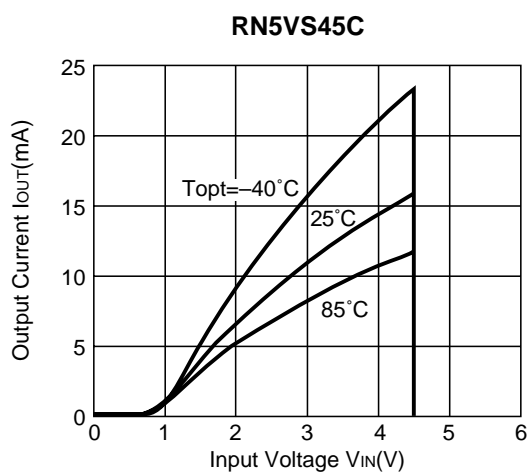
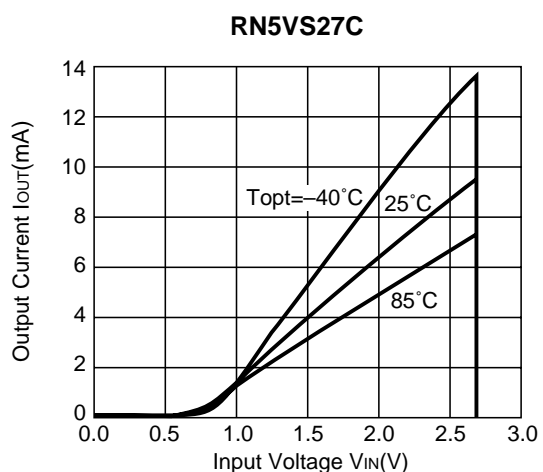
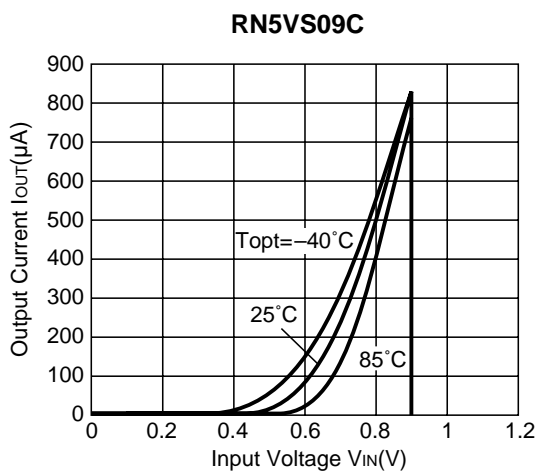

6) Pch Driver Output Current vs. Input Voltage

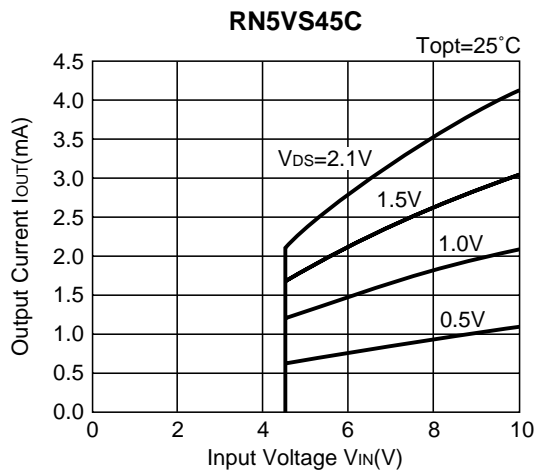
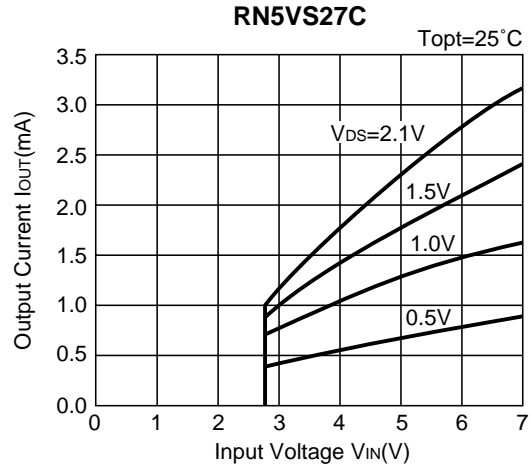
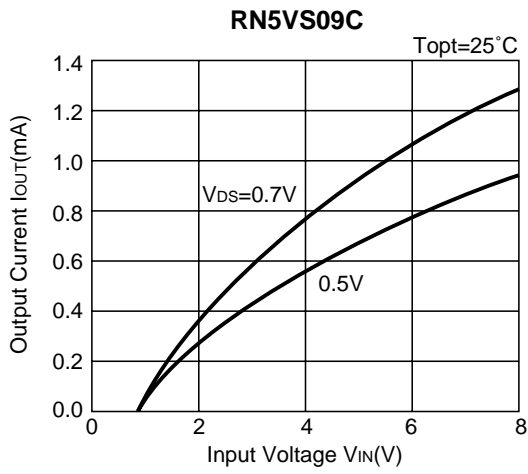

7) Output Delay Time vs. Load Capacitance

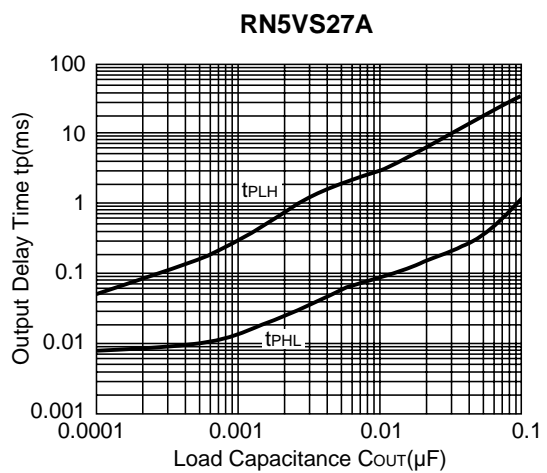
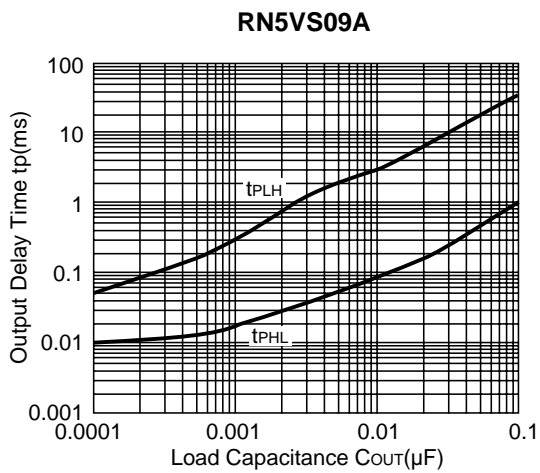

RN5VS45A

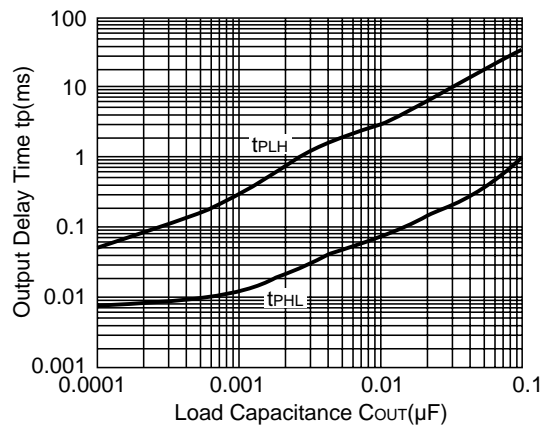

8) Output Delay Time vs. Input Pin Capacitance

RN5VS09A

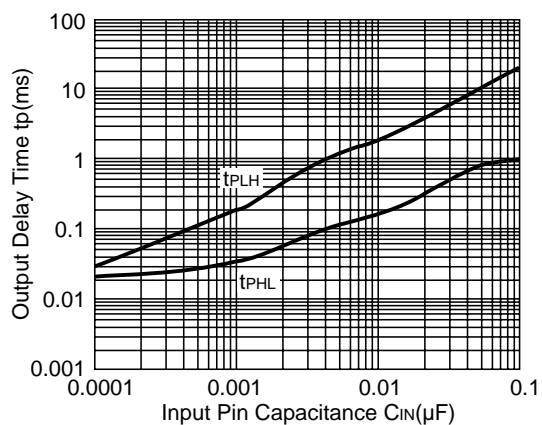

RN5VS27A

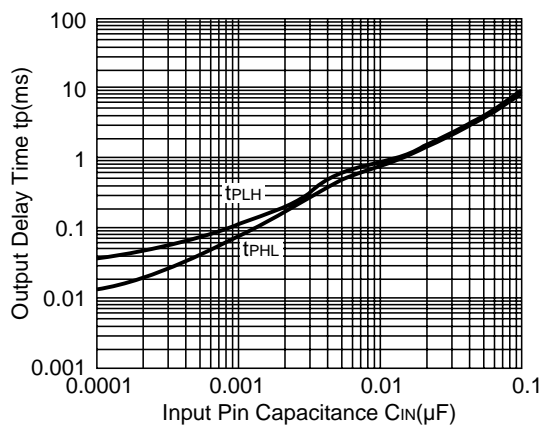

RN5VS45A

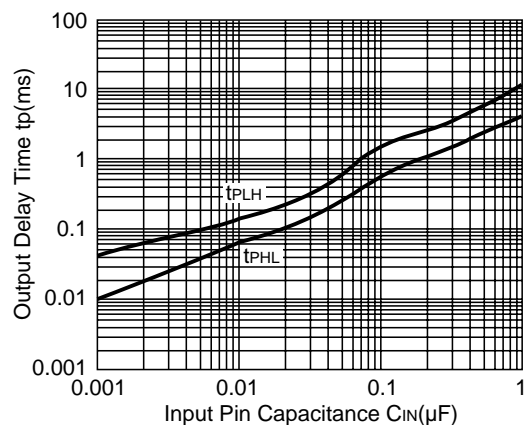

TYPICAL APPLICATIONS

• RN5VS××A CPU Reset Circuit (Nch Open Drain Output)

(1) Input Voltage to RN5VS××A is the same as the input voltage to CPU.

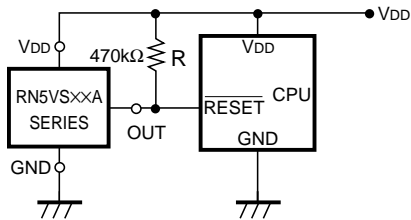

(2) Input Voltage to RN5VS××A is different from the input voltage to CPU.

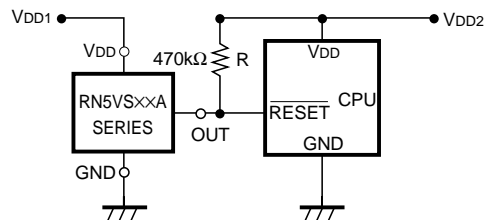

• RN5VS××C CPU Reset Circuit (CMOS Output)

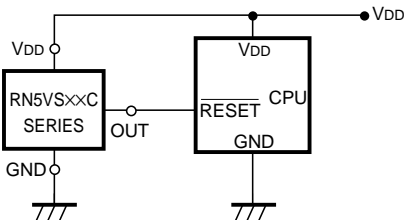

• RN5VS××A Output delay Time Circuit 1

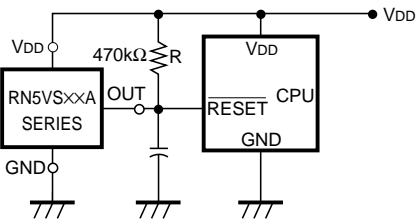

• RN5VS××A Output delay Time Circuit 2

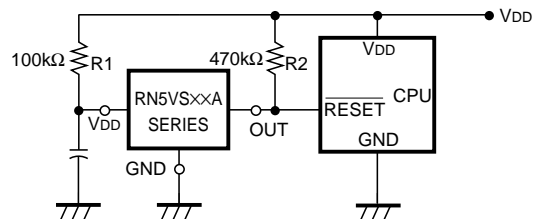

• Memory Back-up Circuit

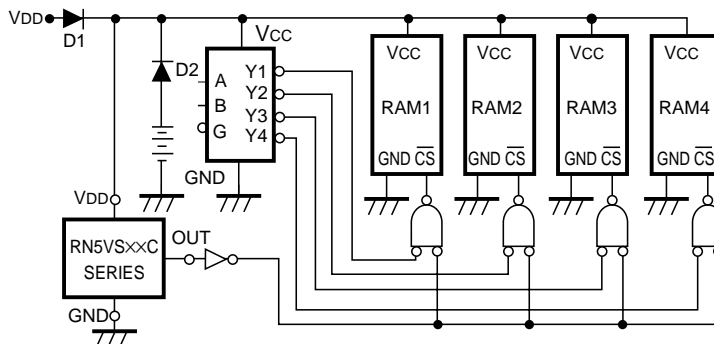

• **Voltage Level Indicator Circuit (lighted when the power runs out)**
 (Nch Open Drain Output)

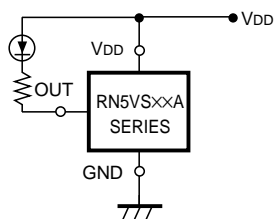

• **Detector Threshold Changing Circuit**
 (Nch Open Drain Output)

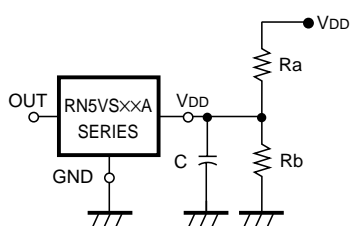

$$\text{Changed Detector Threshold} = \frac{Ra + Rb}{Rb} \cdot (-V_{DET})$$

$$\text{Hysteresis Voltage} = \frac{Ra + Rb}{Rb} \cdot V_{HYS}$$

(Note) Please note that when the value of Ra becomes excessively large, the detector threshold detected may differ from the value calculated by use of the above formula.

• **Window Comparator Circuit**
 (Nch Open Drain Output)

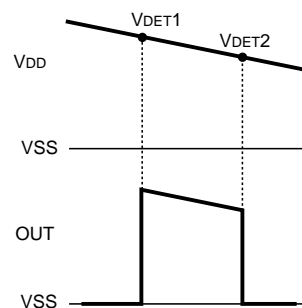
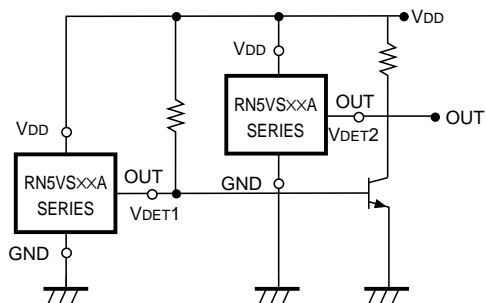

• **Excessive Charge Preventing Circuit**

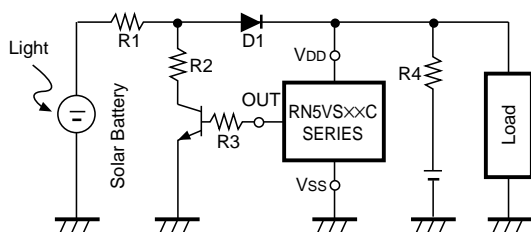

APPLICATION HINTS

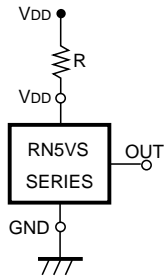

FIG. 9

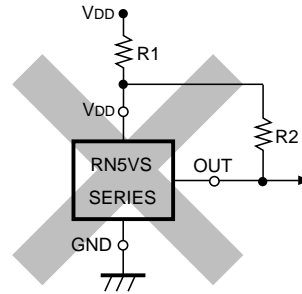
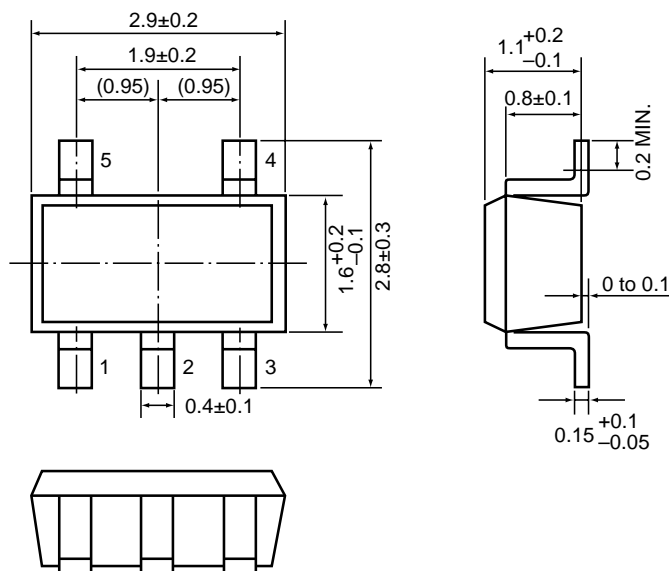

FIG. 10

1. When RN5VS $\times\times$ C (CMOS Output) is used in FIG. 9, this IC may oscillate by the through-type current at the detection when impedance is connected between Power Source VDD and RN5VS VDD Pin. When RN5VS $\times\times$ A (Nch Open Drain Output) is used in FIG. 9, and R becomes excessively large, Detector Threshold may be varied because of the voltage drop of the supply current in the IC itself.
2. The connection as shown in FIG. 10 may cause the oscillation in both RN5VS $\times\times$ C (CMOS Output) and RN5VS $\times\times$ A (Nch Open Drain Output).

PACKAGE DIMENSIONS (Unit: mm)

• SOT-23-5



TAPING SPECIFICATIONS (Unit: mm)

• SOT-23-5

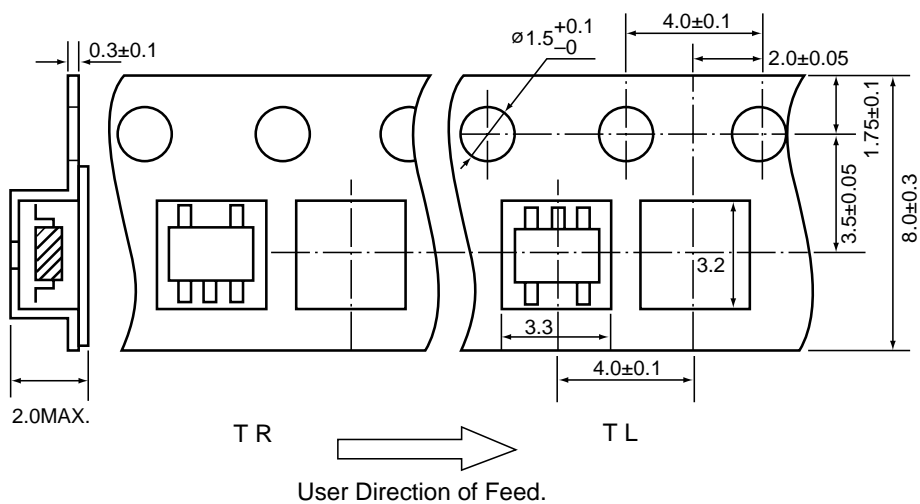



RICOH COMPANY, LTD.
ELECTRONIC DEVICES DIVISION

HEADQUARTERS

13-1, Himemuro-cho, Ikeda City, Osaka 563, JAPAN
Phone 81-727-53-1111 Fax 81-727-53-6011

YOKOHAMA OFFICE (International Sales)

3-2-3, Shin-Yokohama, Kohoku-ku, Yokohama City, Kanagawa 222,
JAPAN
Phone 81-45-477-1697 Fax 81-45-477-1694 · 1695

RICOH CORPORATION
ELECTRONIC DEVICES DIVISION

SAN JOSE OFFICE

3001 Orchard Parkway, San Jose, CA 95134-2088, U.S.A.
Phone 1-408-432-8800 Fax 1-408-432-8375