

Dual Low Dropout Regulator with Detector

General Description

The RT9002A/B/C is a dual-channel, low noise, and low dropout regulator. The first regulator is capable of sourcing 240mA, while the second regulator can source up to 500mA and includes a voltage detection function. The RT9002A/B/C performance is optimized for CD/DVD-ROM, CD/RW or wireless communication supply applications. The RT9002A/B/C regulator is stable with output capacitors as low as 1 μ F. The other features include high output accuracy, ultra-fast transient response, tight load and line regulation, current limiting/thermal protection and high ripple rejection ratio. The RT9002A/B/C is available in SOP-8 package requiring minimum board space and smallest components.

Ordering Information

RT9002A/B/C-□□

- Package Type
S : SOP-8
- Lead Plating System
P : Pb Free
G : Green (Halogen Free and Pb Free)
- Output Voltage : V_{OUT1}/V_{OUT2}
A : 2.5V/3.3V
B : 1.5V/2.8V
C : 2.5V/3.3V

Note :

Richtek products are :

- ▶ RoHS compliant and compatible with the current requirements of IPC/JEDEC J-STD-020.
- ▶ Suitable for use in SnPb or Pb-free soldering processes.

Features

- Low Quiescent Current (Typically 70 μ A)
- Wide Operating Voltage Ranges : 2.5V to 5.5V
- Ultra-Fast Transient Response
- Tight Load and Line Regulation
- Current Limiting Protection
- Thermal Shutdown Protection
- Only Low ESR Ceramic Capacitors Required for Stability
- Custom LDO V_{OUT1}, V_{OUT2} Voltage Available from 1.5V to 3.3V
- Custom V_{IN} Detector Available from 3.5V to 4V
- RoHS Compliant and 100% Lead (Pb)-Free

Applications

- CD/DVD-ROM, CD/RW
- Wireless LAN Card/Keyboard/Mouse
- Battery-Powered Equipment
- XDSL Router

Pin Configurations

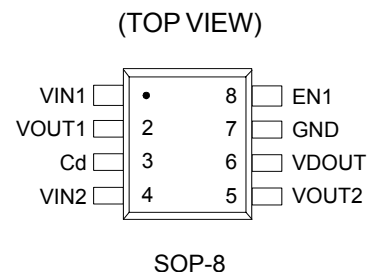

Typical Application Circuit

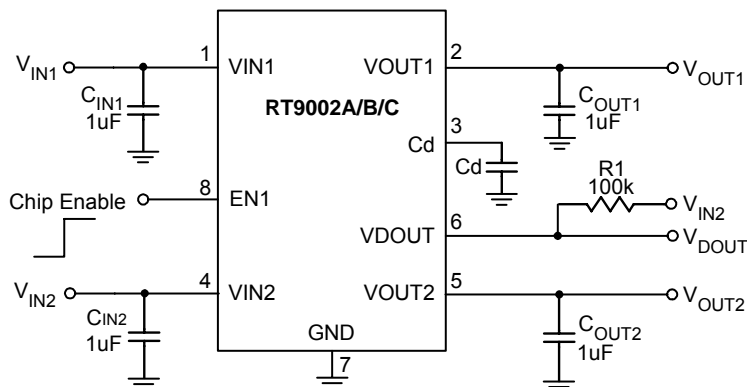

Functional Pin Description

| Pin No. | Pin Name | Pin Function |
|---------|----------|--|
| 1 | VIN1 | Channel 1 Supply Input. |
| 2 | VOUT1 | Channel 1 Output Voltage. |
| 3 | Cd | Delay Capacitor. |
| 4 | VIN2 | Channel 2 Supply Voltage. |
| 5 | VOUT2 | Channel 2 Output Input. |
| 6 | VDOUT | Detector Output Voltage. (RT9002A = Active High, RT9002B and RT9002C = Active Low) |
| 7 | GND | Common Ground. |
| 8 | EN1 | Chip Enable (Active High) for Channel 1. |

Function Block Diagram

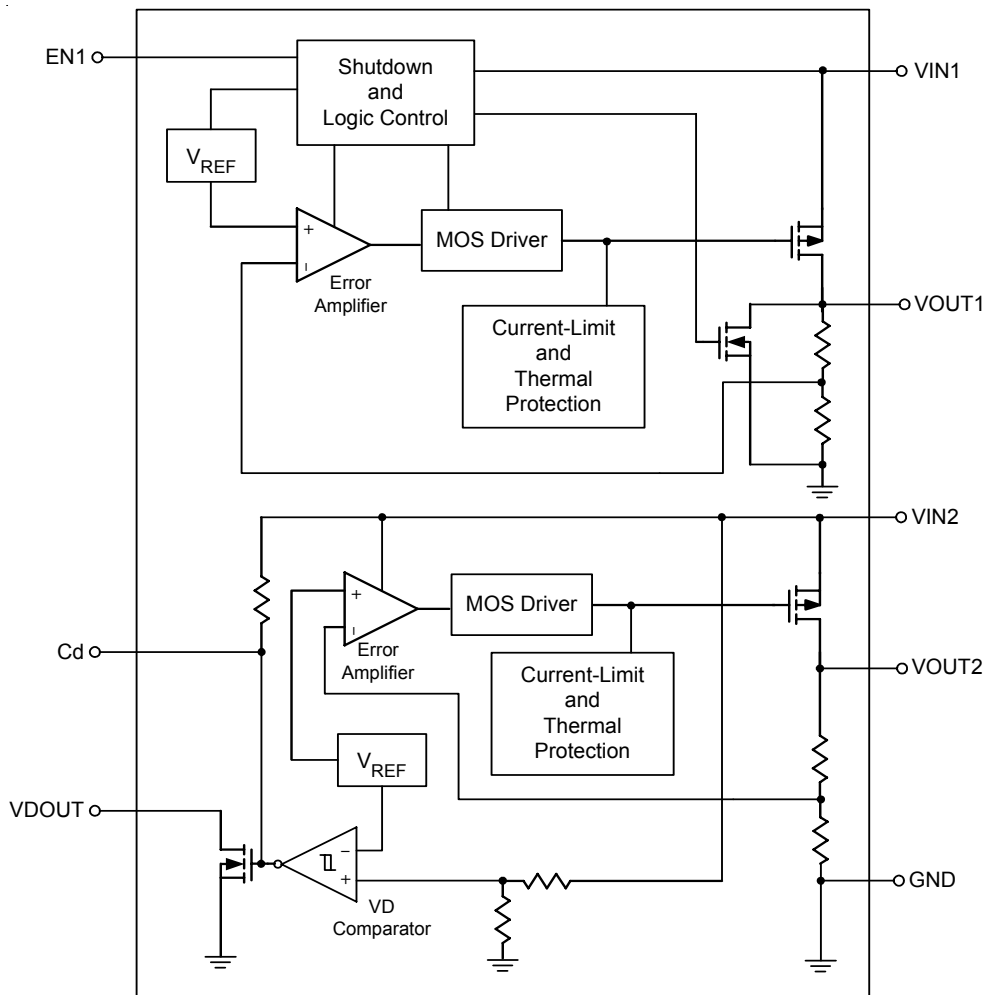

Absolute Maximum Ratings (Note 1)

- Supply Input Voltage ----- 6V
- Package Thermal Resistance (Note 2)
SOP-8, θ_{JA} ----- 110°C/W
- Power Dissipation, P_D @ $T_A = 25^\circ\text{C}$
SOP-8 ----- 0.909W
- Lead Temperature (Soldering, 10 sec.) ----- 260°C
- Junction Temperature ----- 150°C
- Storage Temperature Range ----- -65°C to 150°C
- ESD Susceptibility (Note 3)
HBM (Human Body Mode) ----- 2kV
MM (Machine Mode) ----- 200V

Recommended Operating Conditions (Note 4)

- Supply Input Voltage ----- 2.5V to 5.5V
- Chip Enable Input Voltage ----- 0V to 5.5V
- Junction Temperature Range ----- -40°C to 125°C
- Ambient Temperature Range ----- -40°C to 125°C

Electrical Characteristics

($V_{IN} = V_{OUT} + 1V$, whichever is greater, $C_{IN} = 1\mu\text{F}$, $C_{OUT} = 1\mu\text{F}$, $T_A = 25^\circ\text{C}$, unless otherwise specified)

| Parameter | Symbol | Test Conditions | Min | Typ | Max | Unit |
|-----------------------------|--------------------|--|------|------|------|------------------|
| Regulator 1 | | | | | | |
| Output Voltage Accuracy | RT9002A | ΔV_{OUT1} $I_{OUT1} = 30\text{mA}$ | 2.45 | 2.5 | 2.55 | V |
| | RT9002B | | 1.47 | 1.5 | 1.53 | |
| | RT9002C | | 2.45 | 2.5 | 2.55 | |
| Maximum Output Current | I_{OUT1_MAX} | | 240 | -- | -- | mA |
| Load Regulation (Note 5) | ΔV_{LOAD1} | $1\text{mA} < I_{OUT1} < 100\text{mA}$ | -- | 1 | -- | mV |
| Dropout Voltage (Note 6) | V_{DROP1_1} | $I_{OUT1} = 30\text{mA}$ | -- | 50 | -- | mV |
| | V_{DROP1_2} | $I_{OUT1} = 100\text{mA}$ | -- | 150 | -- | |
| Quiescent Current (Note 7) | I_{Q1} | $V_{IN1} = V_{EN1} = 3.5V$, $I_{OUT1} = 0\text{mA}$ | -- | 30 | -- | μA |
| Standby Current | I_{STB1} | $V_{IN1} = 3.5V$, $V_{EN1} = 0V$ | -- | 0.1 | 1 | μA |
| Line Regulation | ΔV_{LINE1} | $V_{IN1} = 3.5V$ to $5.5V$, $V_{IN1} = V_{EN1}$, $I_{OUT1} = 30\text{mA}$ | -- | 0.01 | 0.2 | %/V |
| Power Supply Rejection Rate | PSRR1 | $f = 100\text{Hz}$, $I_{OUT1} = 100\text{mA}$ | -- | -60 | -- | dB |
| Current Limit | I_{LIM1} | $V_{IN1} = V_{EN1} = 5V$ | -- | 450 | -- | mA |
| EN Threshold Voltage | Logic-Low | V_{IL} | -- | -- | 0.6 | V |
| | Logic-High | V_{IH} | 1.8 | -- | -- | |
| Thermal Shutdown Protection | T_{SD1} | | -- | 170 | -- | $^\circ\text{C}$ |

To be continued

| Parameter | | Symbol | Test Conditions | Min | Typ | Max | Unit |
|-----------------------------|---------|--------------------|---|----------------------|----------------------|----------------------|------|
| Thermal Shutdown Hysteresis | | ΔT_{SD1} | | -- | 40 | -- | °C |
| Enable Pin Current | | I_{EN} | $V_{IN} = 3.5V$, Enable | -- | 0.1 | 1 | μA |
| Regulator 2 | | | | | | | |
| Output Voltage Accuracy | RT9002A | ΔV_{OUT2} | $I_{OUT2} = 30mA$ | 3.234 | 3.3 | 3.366 | V |
| | RT9002B | | | 2.744 | 2.8 | 2.856 | |
| | RT9002C | | | 3.234 | 3.3 | 3.366 | |
| Maximum Output Current | | I_{OUT2_MAX} | | 500 | -- | -- | mA |
| Load Regulation (Note 5) | | ΔV_{LOAD2} | $1mA < I_{OUT2} < 100mA$ | -- | 15 | 50 | mV |
| Dropout Voltage (Note 6) | | V_{DROP2_1} | $I_{OUT2} = 30mA$ | -- | 50 | 90 | mV |
| | | V_{DROP2_2} | $I_{OUT2} = 100mA$ | -- | 150 | 200 | |
| Quiescent Current (Note 7) | | I_{Q2} | $V_{IN2} = 4.3V$, $I_{OUT2} = 0mA$ | -- | 40 | -- | μA |
| Line Regulation | | ΔV_{LINE2} | $V_{IN2} = 4.3V$ to $5.5V$, $I_{OUT2} = 30mA$ | -- | 0.01 | 0.2 | %/V |
| Power Supply Rejection Rate | | PSRR2 | $f = 100Hz$, $I_{OUT2} = 100mA$ | -- | -60 | -- | dB |
| Current Limit | | I_{LIM2} | $V_{IN2} = 5V$ | -- | 800 | -- | mA |
| Thermal Shutdown Protection | | T_{SD2} | | -- | 170 | -- | °C |
| Thermal Shutdown Hysteresis | | ΔT_{SD2} | | -- | 40 | -- | °C |
| Detector | | | | | | | |
| Detect Fall Voltage | RT9002A | V_{DF} | | 3.528 | 3.6 | 3.672 | V |
| | RT9002B | | | 3.822 | 3.9 | 3.978 | |
| | RT9002C | | | 3.528 | 3.6 | 3.672 | |
| Hysteresis | | ΔV_{HYS} | | $V_{DF} \times 0.02$ | $V_{DF} \times 0.05$ | $V_{DF} \times 0.08$ | V |
| Sink Current | RT9002A | I_{DOUT} | $V_{DOUT} = 0.5V$, $V_{IN2} = 5.0V$ | 7 | 12 | -- | mA |
| | RT9002B | | $V_{DOUT} = 0.5V$, $V_{IN2} = 2.0V$ | 4 | 8 | -- | |
| | RT9002C | | $V_{DOUT} = 0.5V$, $V_{IN2} = 2.0V$ | 4 | 8 | -- | |

Note 1. Stresses listed as the above “Absolute Maximum Ratings” may cause permanent damage to the device. These are for stress ratings. Functional operation of the device at these or any other conditions beyond those indicated in the operational sections of the specifications is not implied. Exposure to absolute maximum rating conditions for extended periods may remain possibility to affect device reliability.

Note 2. θ_{JA} is measured in the natural convection at $T_A = 25^\circ\text{C}$ on a high effective thermal conductivity test board of JEDEC 51-7 2S2P 4-layer thermal measurement standard.

Note 3. Devices are ESD sensitive. Handling precaution recommended.

Note 4. The device is not guaranteed to function outside its operating conditions.

Note 5. Regulation is measured at constant junction temperature by using a 20ms current pulse. Devices are tested for load regulation in the load range from 1mA to 100mA.

Note 6. The dropout voltage is defined as $V_{IN} - V_{OUT}$, which is measured when V_{OUT} is $V_{OUT(NORMAL)} - 100\text{mV}$.

Note 7. Quiescent, or ground current, is the difference between input and output currents. It is defined by $I_Q = I_{IN} - I_{OUT}$ under no load condition ($I_{OUT} = 0\text{mA}$). The total current drawn from the supply is the sum of the load current plus the ground pin current.

Typical Operating Characteristics

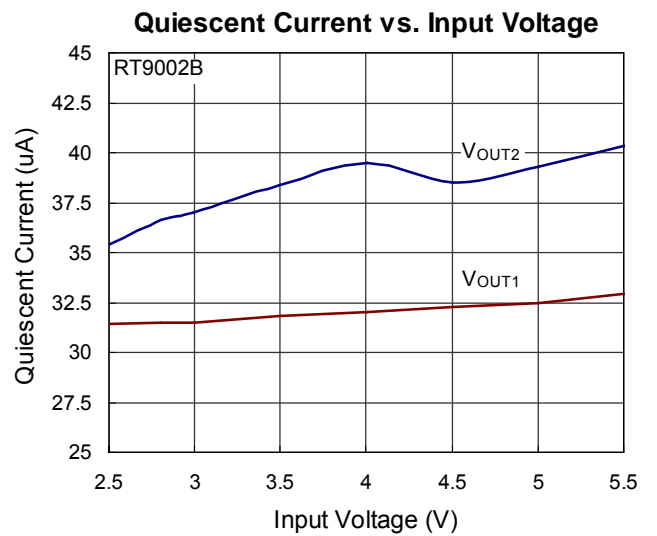
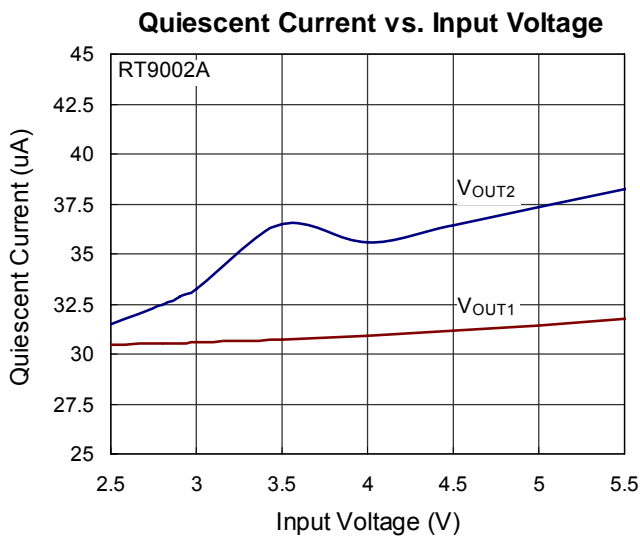
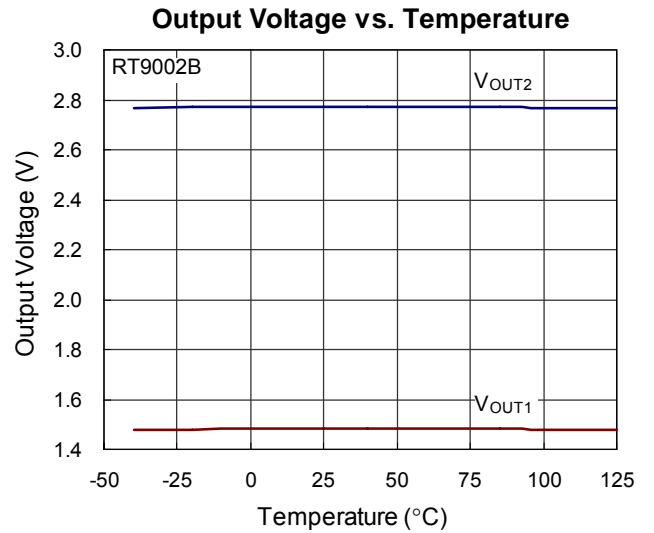
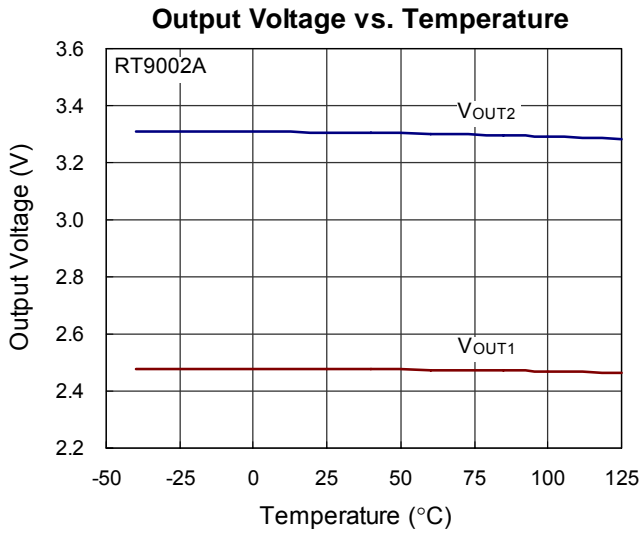
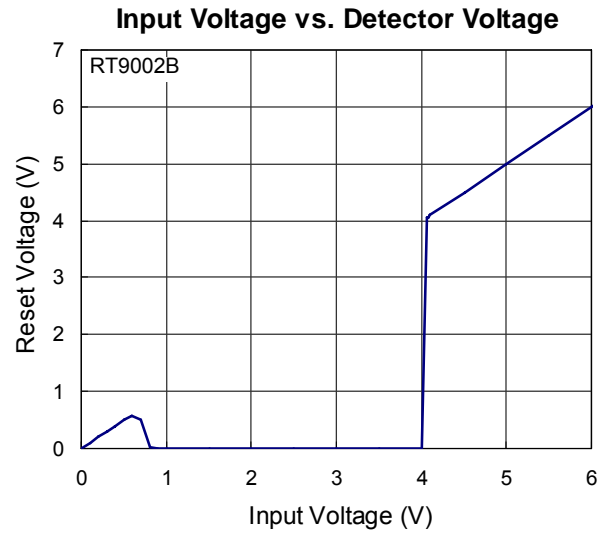
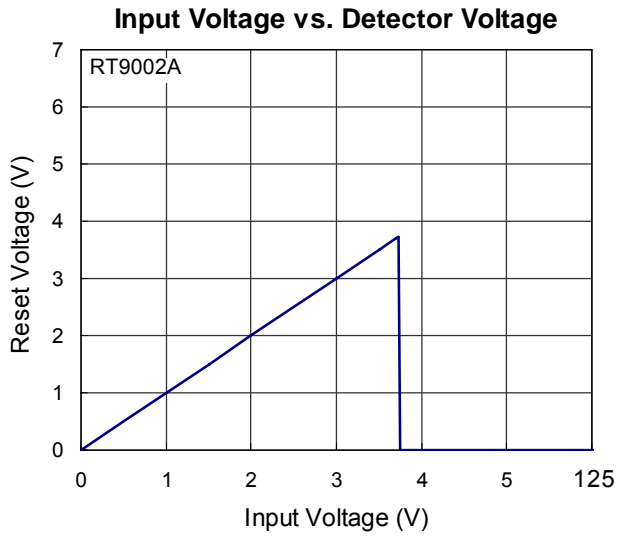

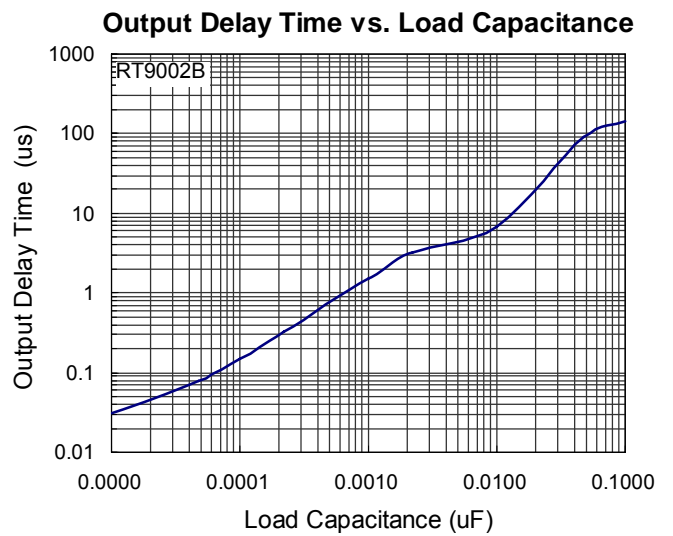
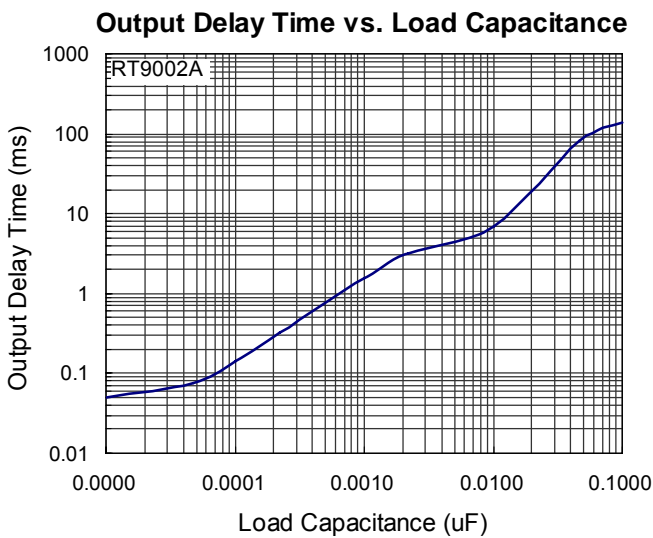
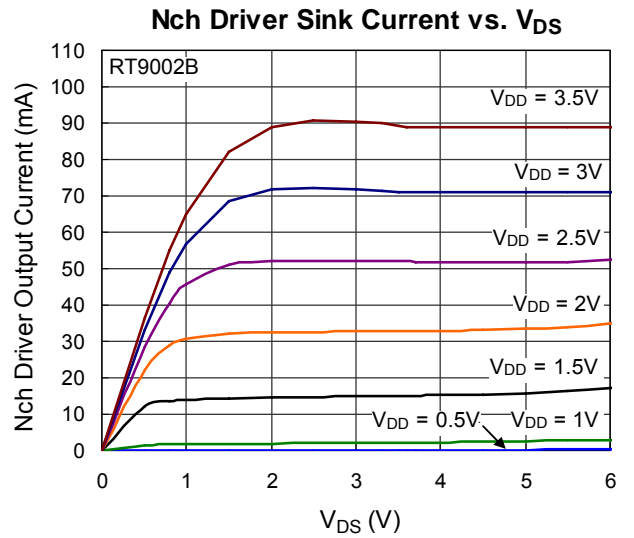
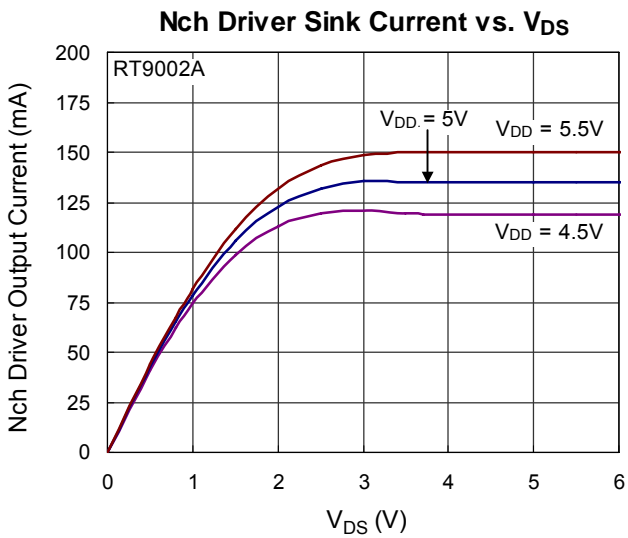
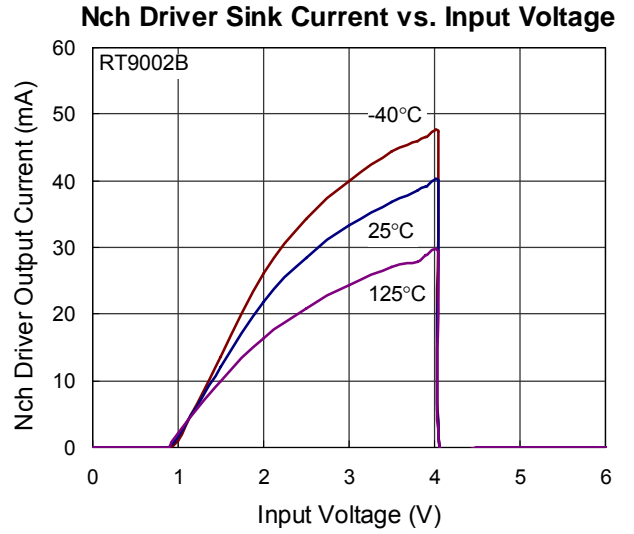
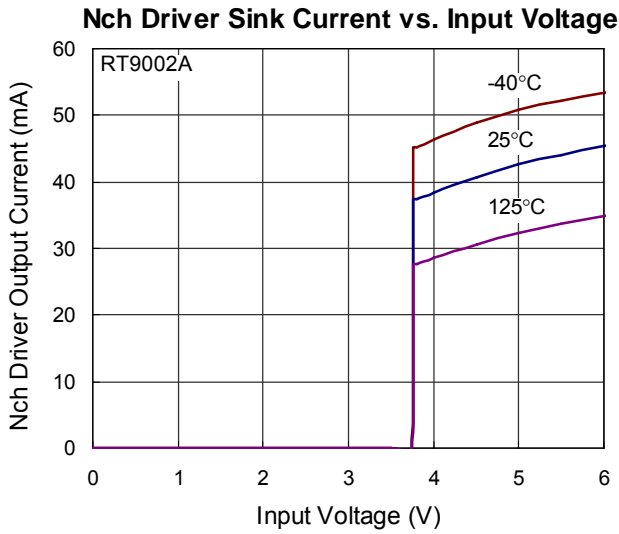

Dropout Voltage vs. Load Current

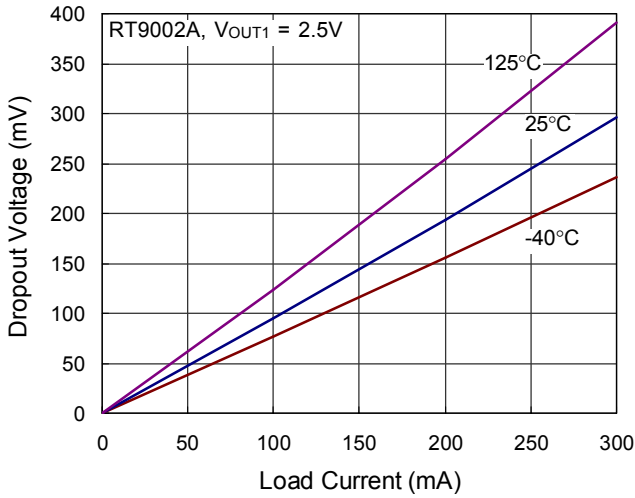

Dropout Voltage vs. Load Current

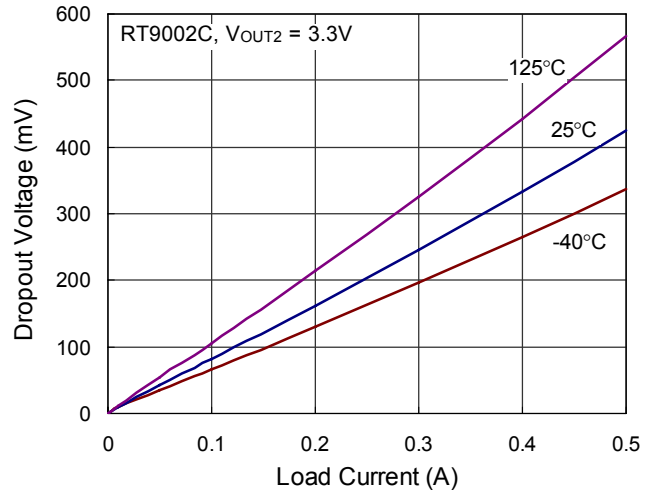

EN Pin Shutdown Response

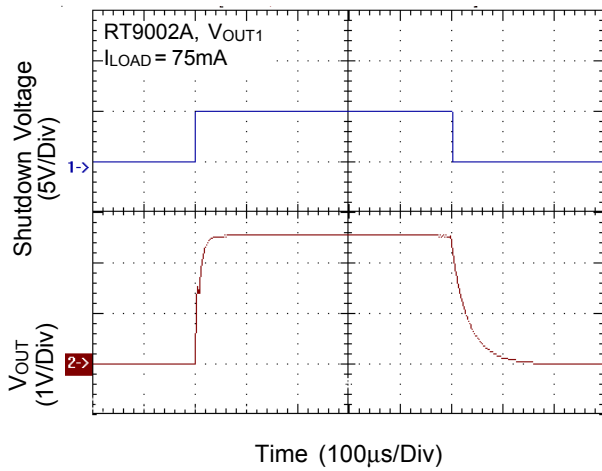

Line Transient Response

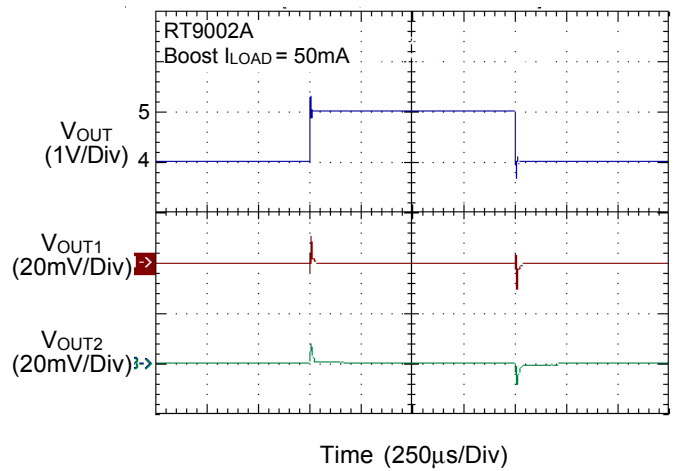

Load Transient Response

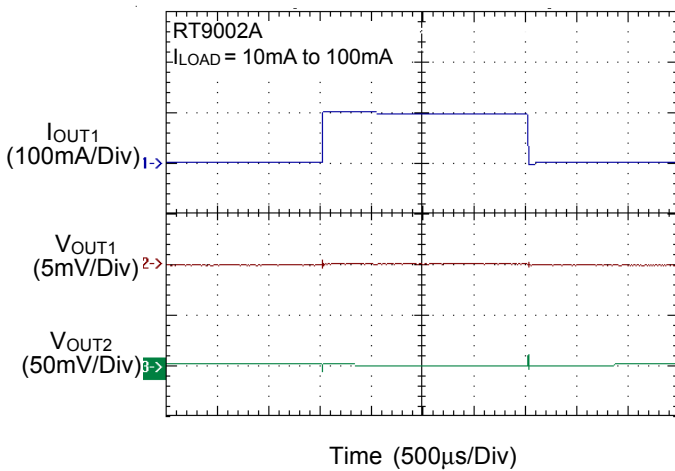

Start Up

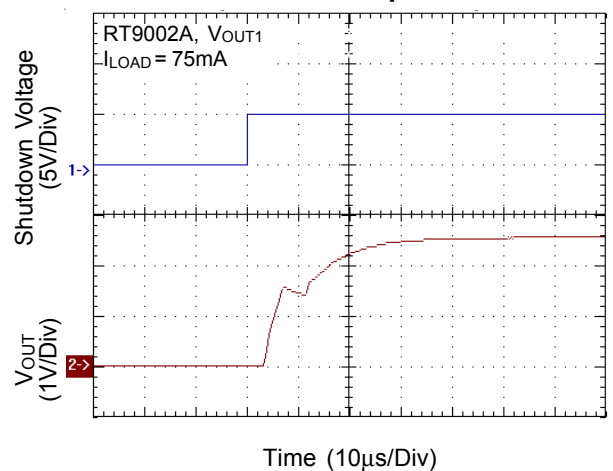

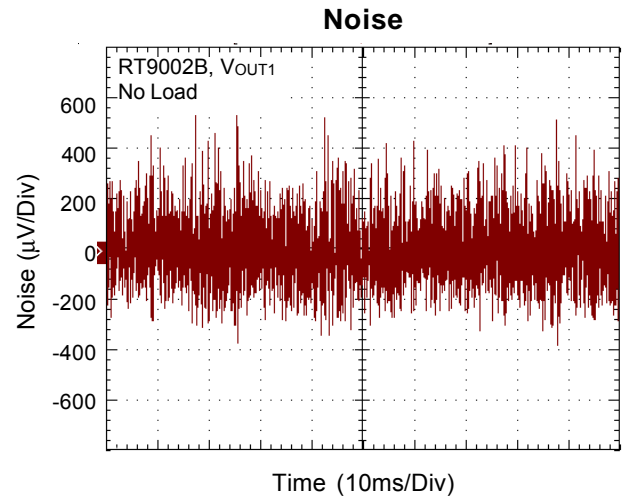
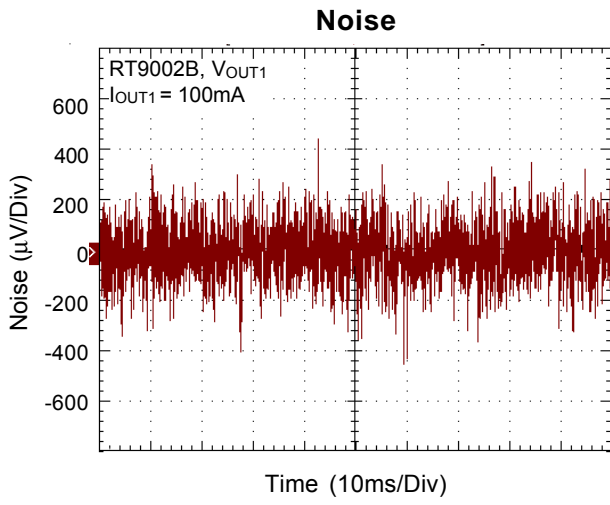

Applications Information

Like any low-dropout regulator, the external capacitors used with the RT9002A/B/C must be carefully selected for regulator stability and performance. Using a capacitor whose value is $> 1\mu\text{F}$ on the RT9002A/B/C input and the amount of capacitance can be increased without limit. The input capacitor must be located a distance of not more than 0.5 inch from the input pin of the IC and returned to a clean analog ground. Any good quality ceramic can be used for this capacitor. The capacitor with larger value and lower ESR (equivalent series resistance) provides better PSRR and line-transient response.

The output capacitor must meet both requirements for minimum amount of capacitance and ESR in all LDOs application. The RT9002A/B/C is designed specifically to work with low ESR ceramic output capacitor in space-saving and performance consideration. Using a ceramic capacitor whose value is at least $1\mu\text{F}$ with ESR is $> 20\text{m}\Omega$ on the RT9002A/B/C output ensures stability. The RT9002A/B/C still works well with output capacitor of other types due to the wide stable ESR range. Figure 1. shows the curves of allowable ESR range as a function of load current for various output capacitor values. Output capacitor of larger capacitance can reduce noise and improve load transient response, stability, and PSRR. The output capacitor should be located not more than 0.5 inch from the VOUT pin of the RT9002A/B/C and returned to a clean analog ground.

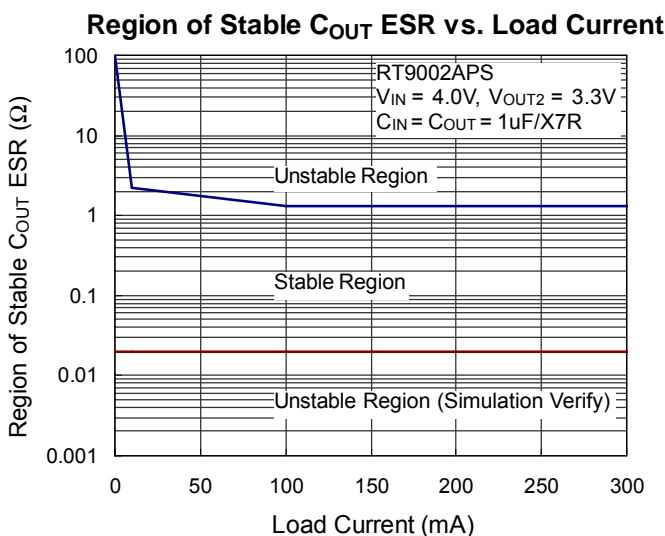

Figure 1

Enable

The RT9002A/B/C goes into sleep mode when the Enable pin is in a logic low condition. During this condition, the pass transistor, error amplifier, and bandgap are turned off, reducing the supply current to $0.1\mu\text{A}$ typical. The Enable pin may be directly tied to V_{IN} to keep the part on. The Enable input is CMOS logic and cannot be left floating.

PSRR

The power supply rejection ratio (PSRR) is defined as the gain from the input to output divided by the gain from the supply to the output. The PSRR is found to be

$$\text{PSRR} = 20 \times \log \left(\frac{\Delta \text{Gain Error}}{\Delta \text{Supply}} \right)$$

Note that when heavy load measuring, Δsupply will cause $\Delta\text{temperature}$. And $\Delta\text{temperature}$ will cause Δoutput voltage. So the heavy load PSRR measuring is include temperature effect.

Current Limit

The RT9002A/B/C contains an independent current limiter, which monitors and controls the pass transistor's gate voltage, limiting the output current to $0.45/0.8\text{A}$ (typ.). The output can be shorted to ground indefinitely without damaging the part.

Thermal-Shutdown Protection

Thermal-shutdown protection limits total power dissipation in the RT9002A/B/C. When the junction temperature exceeds $T_J = +170^\circ\text{C}$, the thermal sensor signals the shutdown logic, turning off the pass transistor and allowing the IC to cool. The thermal sensor turns the pass transistor on again after the IC's junction temperature cools by 40°C , resulting in a pulsed output during continuous thermal overload conditions. Thermal-shutdown protection is designed to protect the RT9002A/B/C in the event of fault conditions. For continual operation, do not exceed the absolute maximum junction temperature rating of $T_J = +125^\circ\text{C}$.

Outline Dimension

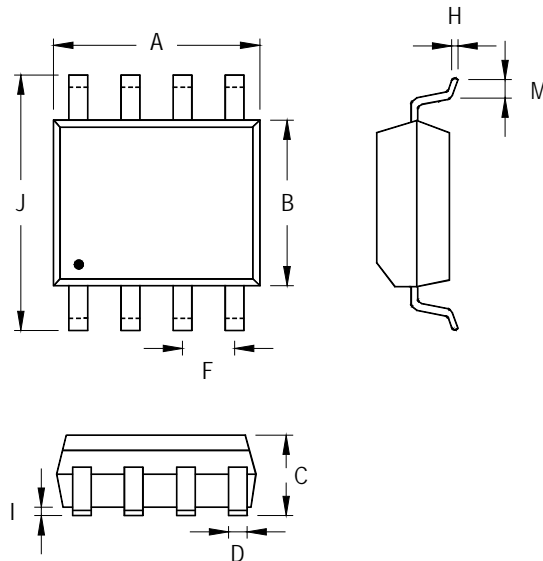

| Symbol | Dimensions In Millimeters | | Dimensions In Inches | |
|--------|---------------------------|-------|----------------------|-------|
| | Min | Max | Min | Max |
| A | 4.801 | 5.004 | 0.189 | 0.197 |
| B | 3.810 | 3.988 | 0.150 | 0.157 |
| C | 1.346 | 1.753 | 0.053 | 0.069 |
| D | 0.330 | 0.508 | 0.013 | 0.020 |
| F | 1.194 | 1.346 | 0.047 | 0.053 |
| H | 0.170 | 0.254 | 0.007 | 0.010 |
| I | 0.050 | 0.254 | 0.002 | 0.010 |
| J | 5.791 | 6.200 | 0.228 | 0.244 |
| M | 0.400 | 1.270 | 0.016 | 0.050 |

8-Lead SOP Plastic Package

Richtek Technology Corporation

Headquarter
 5F, No. 20, Taiyuen Street, Chupei City
 Hsinchu, Taiwan, R.O.C.
 Tel: (8863)5526789 Fax: (8863)5526611

Richtek Technology Corporation

Taipei Office (Marketing)
 5F, No. 95, Minchiuan Road, Hsintien City
 Taipei County, Taiwan, R.O.C.
 Tel: (8862)86672399 Fax: (8862)86672377
 Email: marketing@richtek.com

Information that is provided by Richtek Technology Corporation is believed to be accurate and reliable. Richtek reserves the right to make any change in circuit design, specification or other related things if necessary without notice at any time. No third party intellectual property infringement of the applications should be guaranteed by users when integrating Richtek products into any application. No legal responsibility for any said applications is assumed by Richtek.