

## 80mΩ, 500mA High-Side Power Switch with Flag

### General Description

The RT9706 is a cost-effective, low voltage, single N-Channel MOSFET high-side power switch, optimized for self-powered and bus-powered Universal Serial Bus (USB) applications. The RT9706 equipped with a charge pump circuitry to drive the internal MOSFET switch; the switch's low  $R_{DS(ON)}$  80mΩ, meets USB voltage drop requirements; and a flag output is available to indicate fault conditions to the local USB controller.

Additional features include soft-start to limit inrush current during plug-in, thermal shutdown to prevent catastrophic switch failure from high-current loads, under-voltage lockout (UVLO) to ensure that the device remains off unless there is a valid input voltage present, lower quiescent current as 25μA making this device ideal for portable battery operated equipment.

The RT9706 is available in SOT-23-5 package requiring minimum board space and smallest components.

### Ordering Information

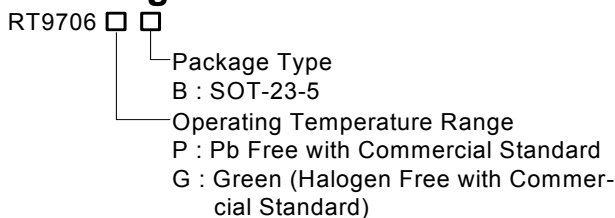

Note :

RichTek Pb-free and Gree products are :

- ▶RoHS compliant and compatible with the current requirements of IPC/JEDEC J-STD-020.
- ▶Suitable for use in SnPb or Pb-free soldering processes.
- ▶100% matte tin (Sn) plating.

### Marking Information

For marking information, contact our sales representative directly or through a RichTek distributor located in your area, otherwise visit our website for detail.

### Features

- Compliant to USB Specifications
- Built-In (Typically 80mΩ) N-Channel MOSFET
- Output Can Be Forced Higher than Input (Off-State)
- Low Supply Current :
  - ▶25μA Typical at Switch On State
  - ▶0.1μA Typical at Switch Off State
- Guaranteed 500mA Continuous Load Current
- Wide Input Voltage Ranges : 2V to 5.5V
- Open-Drain Fault Flag Output
- Hot Plug-In Application (Soft-Start)
- 1.7V Typical Under-Voltage Lockout (UVLO)
- Current Limiting Protection
- Thermal Shutdown Protection
- Reverse Current Flow Blocking (no body diode)
- Smallest SOT-23-5 Package Minimizes Board Space
- UL Approved—E219878 
- RoHS Compliant and 100% Lead (Pb)-Free

### Applications

- USB Bus/Self Powered Hubs
- USB Peripherals
- ACPI Power Distribution
- PC Card Hot Swap
- Notebook, Motherboard PCs
- Battery-Powered Equipment
- Hot-Plug Power Supplies
- Battery-Charger Circuits

### Pin Configurations

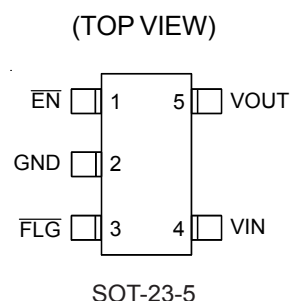

Typical Application Circuit

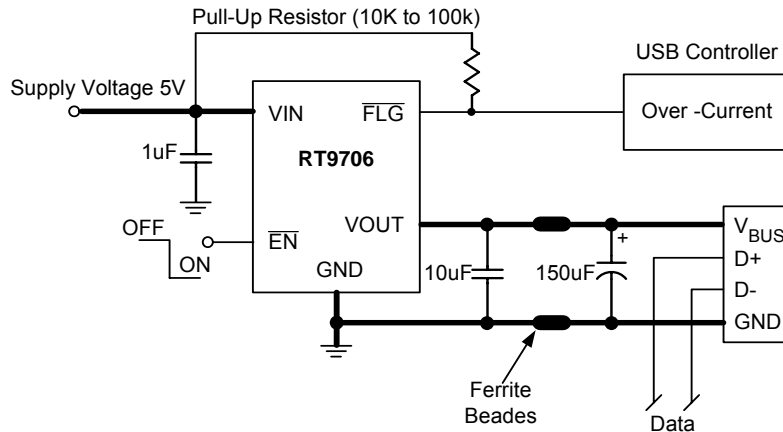

**Note:** A low-ESR 150 $\mu$ F aluminum electrolytic or tantalum between VOUT and GND is strongly recommended to meet the 330mV maximum droop requirement in the hub V<sub>BUS</sub>. (see Application Information Section for further details)

Functional Pin Description

Pin Name	Pin Function
VIN	Power-Input Voltage
VOUT	Output Voltage
GND	Ground
$\overline{\text{EN}}$	Chip Enable (Active Low)
$\overline{\text{FLG}}$	Open-Drain Fault Flag Output

Function Block Diagram

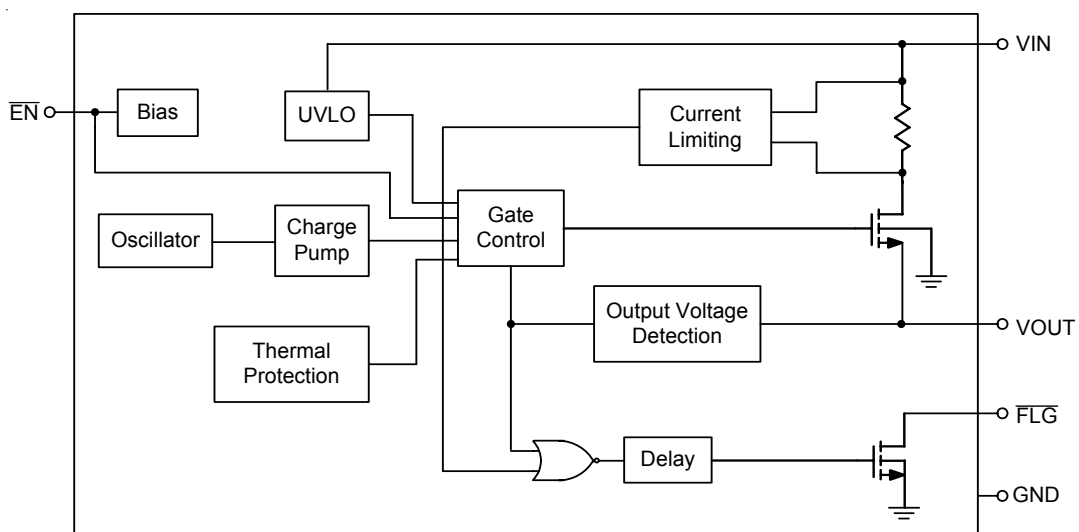

Test Circuits

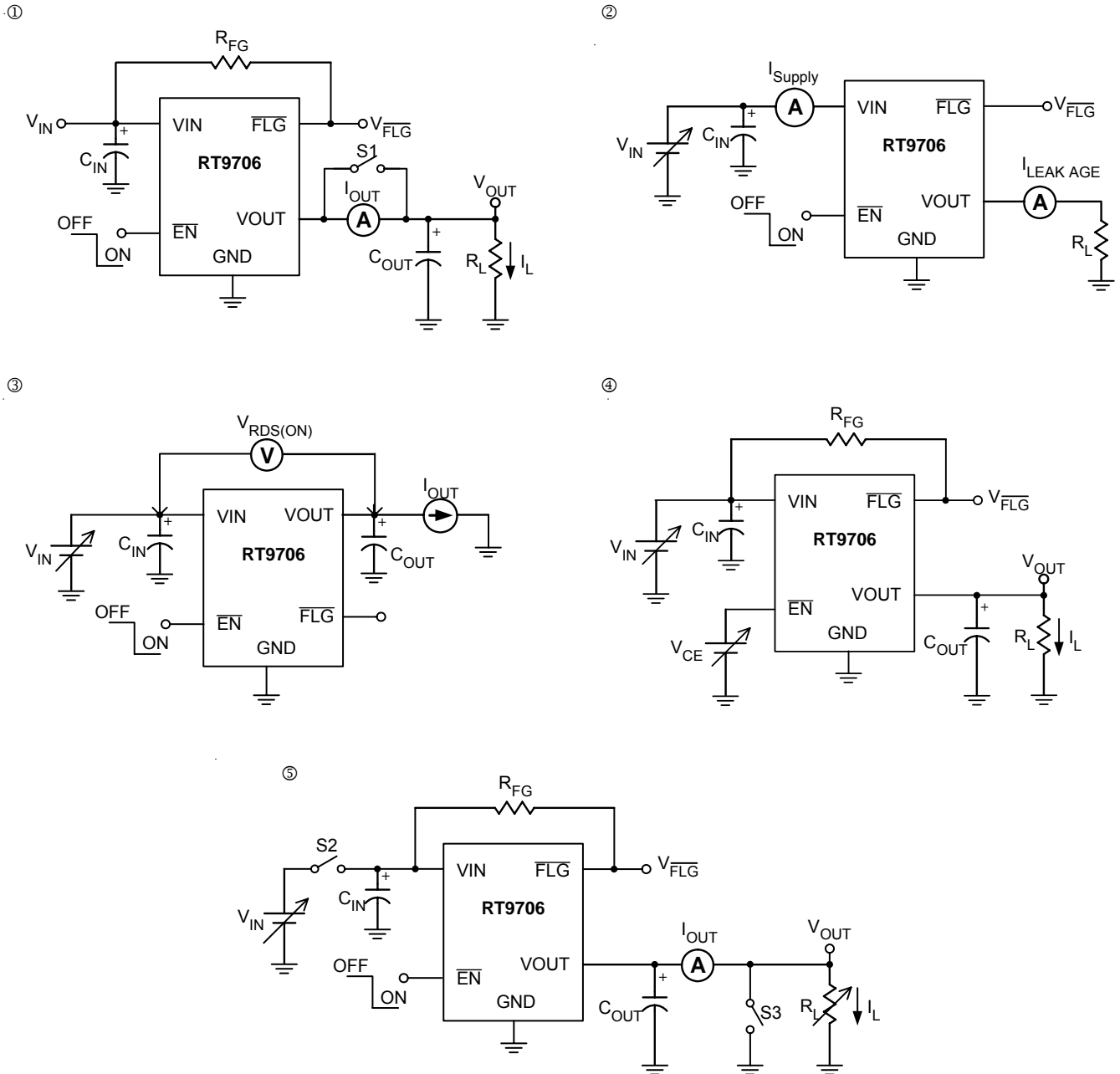

**Note:** Above test circuits reflected the graphs shown on “Typical Operating Characteristics ” are as follows :

- ①—Turn-On Rising & Falling Time vs. Temperature, Turn-On & Off Response, Flag Response
- ②—Supply Current vs. Input Voltage & Temperature, Switch Off Supply Current vs. Temperature, Turn-Off Leakage Current vs. Temperature
- ③—On-Resistance vs. Input Voltage & Temperature
- ④—EN Threshold Voltage vs. Input Voltage & Temperature, Flag Delay Time vs. Input Voltage & Temperature, UVLO Threshold vs. Temperature, UVLO at Rising & Falling
- ⑤—Current Limit vs. Input Voltage/Temperature, Short Circuit Current Response, Short Circuit Current vs. Temperature, Inrush Current Response, Soft-start Response, Ramped Load Response, Current Limit Transient Response, Thermal Shutdown Response

## Absolute Maximum Ratings (Note 1)

- Supply Voltage ----- 6.5V
- Chip Enable Input Voltage ----- -0.3V to 6.5V
- Flag Voltage ----- 6.5V
- Power Dissipation,  $P_D @ T_A = 25^\circ\text{C}$   
SOT-23-5 ----- 0.4W
- Package Thermal Resistance (Note 4)  
SOT-23-5,  $\theta_{JA}$  ----- 250°C/W
- Junction Temperature ----- 150°C
- Lead Temperature (Soldering, 10 sec.) ----- 260°C
- Storage Temperature Range ----- -65°C to 150°C
- ESD Susceptibility (Note 2)  
HBM (Human Body Mode) ----- 2kV  
MM (Machine Mode) ----- 200V

## Recommended Operating Conditions (Note 3)

- Supply Input Voltage ----- 2V to 5.5V
- Chip Enable Input Voltage ----- 0V to 5.5V
- Junction Temperature Range ----- -40°C to 125°C
- Ambient Temperature Range ----- -40°C to 85°C

## Electrical Characteristics

( $V_{IN} = 5V$ ,  $C_{IN} = C_{OUT} = 1\mu\text{F}$ ,  $T_A = 25^\circ\text{C}$ , unless otherwise specified)

Parameter		Symbol	Test Conditions	Min	Typ	Max	Units
Switch On Resistance		$R_{DS(ON)}$	$I_{OUT} = 500\text{mA}$	--	100	130	$\text{m}\Omega$
Supply Current		$I_{SW\_ON}$	switch on, $V_{OUT} = \text{Open}$	--	25	45	$\mu\text{A}$
		$I_{SW\_OFF}$	switch off, $V_{OUT} = \text{Open}$	--	0.1	1	
EN Threshold	Logic-Low Voltage	$V_{IL}$	$V_{IN} = 2V \text{ to } 5.5V$ , switch off	--	--	0.8	V
	Logic-High Voltage	$V_{IH}$	$V_{IN} = 2V \text{ to } 5.5V$ , switch on	2.0	--	--	V
EN Input Current		$I_{EN}$	$V_{EN} = 0V \text{ to } 5.5V$	--	0.01	--	$\mu\text{A}$
Output Leakage Current		$I_{LEAKAGE}$	$V_{EN} = 5V$ , $R_{LOAD} = 0\Omega$	--	0.5	10	$\mu\text{A}$
Output Turn-On Rise Time		$T_{ON\_RISE}$	10% to 90% of $V_{OUT}$ rising	--	400	--	$\mu\text{s}$
Current Limit		$I_{LIM}$	$R_{LOAD} = 1\Omega$	0.5	0.8	1.25	A
FLAG Output Resistance		$R_{FLAG}$	$I_{SINK} = 1\text{mA}$	--	20	400	$\Omega$
FLAG Off Current		$I_{FLAG\_OFF}$	$V_{FLAG} = 5V$	--	0.01	1	$\mu\text{A}$
FLAG Delay Time (Note 5)		$t_D$	From fault condition to $\overline{FLAG}$ assertion	5	12	20	ms
Under-voltage Lockout		$V_{UVLO}$	$V_{IN}$ Rising	1.3	1.7	--	V
Under-voltage Hysteresis		$\Delta V_{UVLO}$		--	0.1	--	V

To be continued

Parameter	Symbol	Test Conditions	Min	Typ	Max	Units
Thermal Shutdown Protection	$T_{SD}$		--	130	--	°C
Thermal Shutdown Hysteresis	$\Delta T_{SD}$		--	20	--	°C

**Note 1.** Stresses listed as the above "Absolute Maximum Ratings" may cause permanent damage to the device. These are for stress ratings. Functional operation of the device at these or any other conditions beyond those indicated in the operational sections of the specifications is not implied. Exposure to absolute maximum rating conditions for extended periods may remain possibility to affect device reliability.

**Note 2.** Devices are ESD sensitive. Handling precaution recommended.

**Note 3.** The device is not guaranteed to function outside its operating conditions.

**Note 4.**  $\theta_{JA}$  is measured in the natural convection at  $T_A = 25^\circ\text{C}$  on a low effective single layer thermal conductivity test board of JEDEC 51-3 thermal measurement standard.

**Note 5.** The FLAG delay time is input voltage dependent, see " Typical Operating Characteristics" graph for further details.

Typical Operating Characteristics

Supply Current vs. Temperature

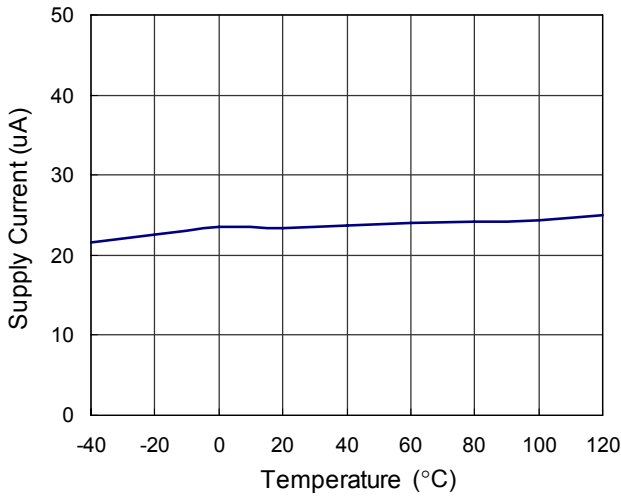

Supply Current vs. Input Voltage

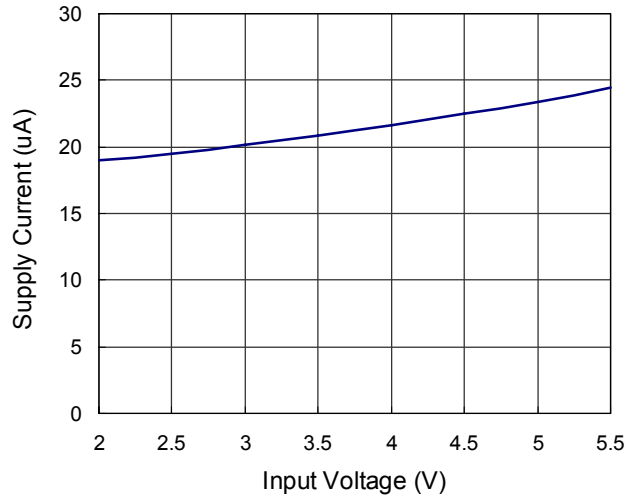

Switch On Resistance vs. Temperature

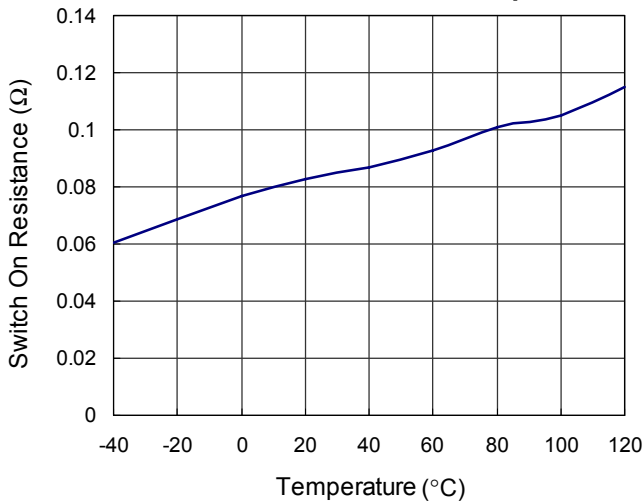

Switch On Resistance vs. Input Voltage

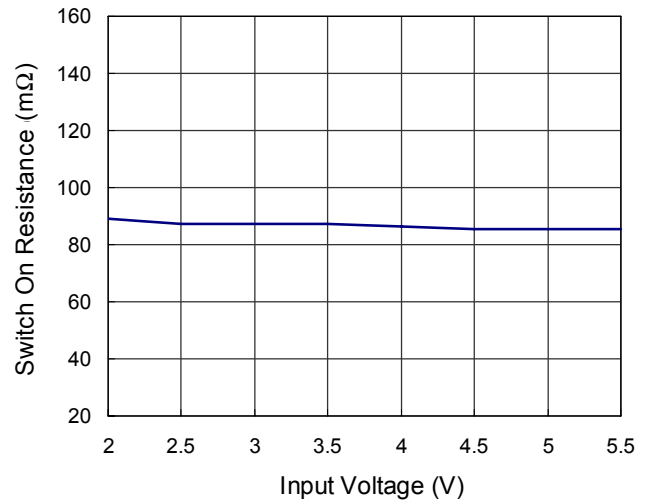

Current Limit vs. Temperature

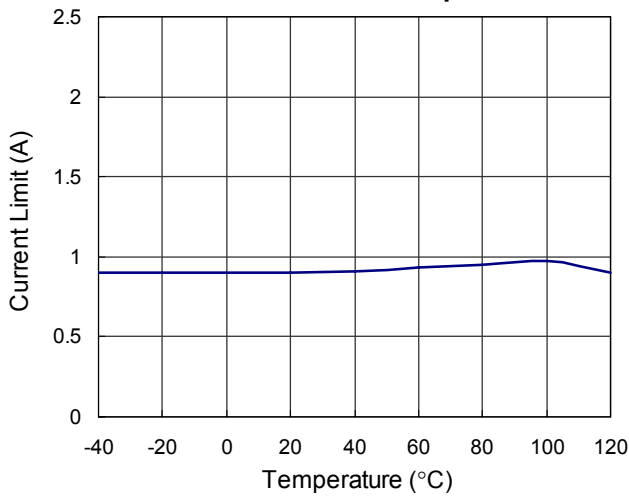

Current Limit vs. Input Voltage

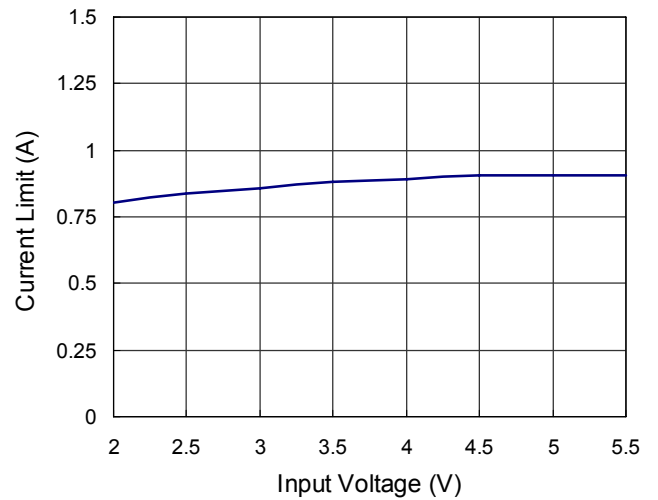

EN Pin Threshold Voltage vs. Temperature

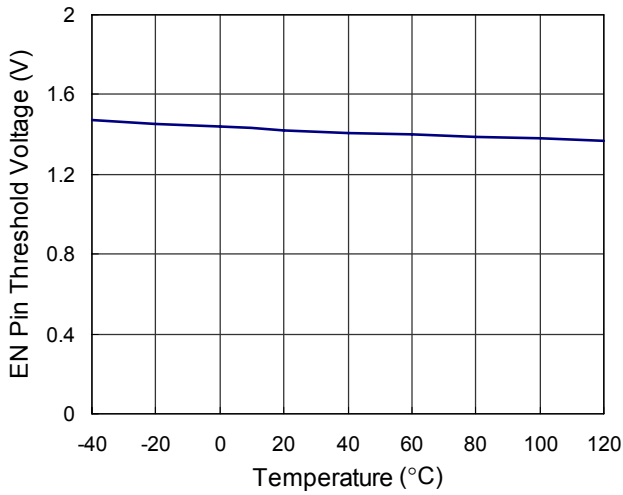

EN Pin Threshold Voltage vs. Input Voltage

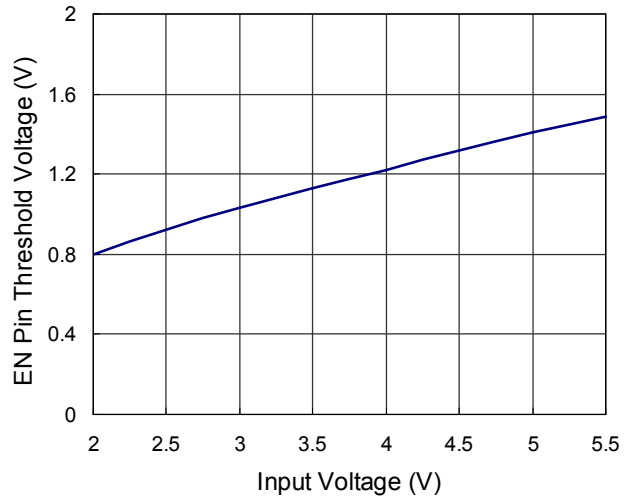

Flag Delay Time vs. Temperature

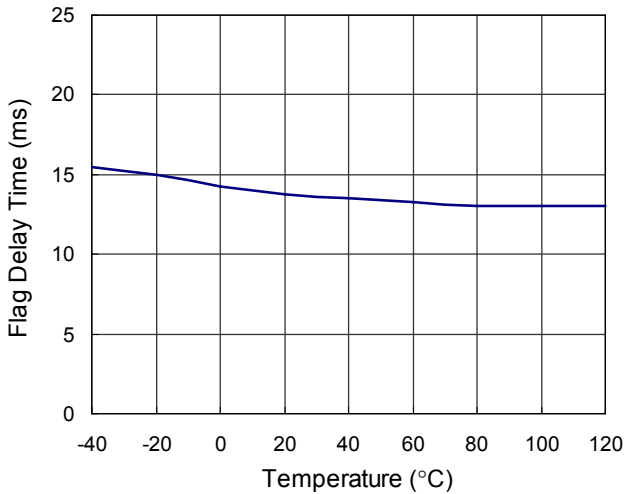

FLAG Delay Time vs. Input Voltage

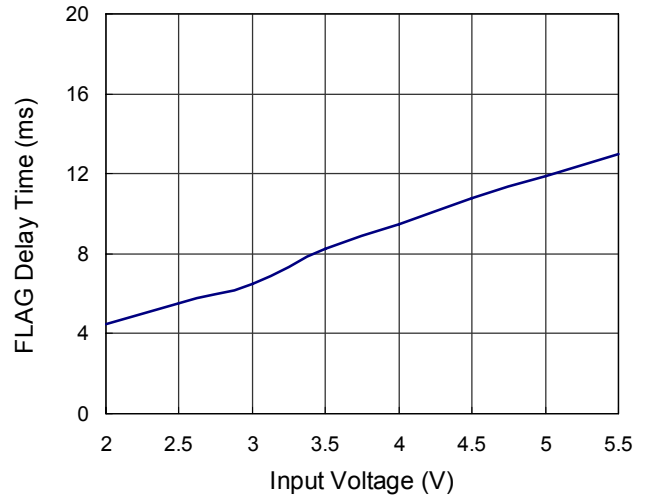

Turn-Off Leakage Current vs. Temperature

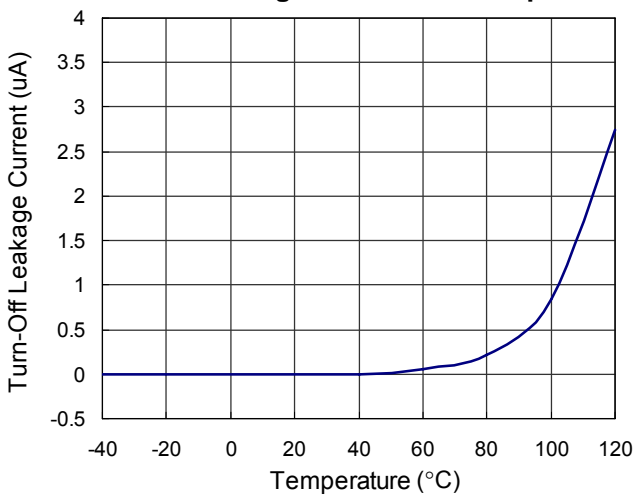

Switch Off Supply Current vs. Temperature

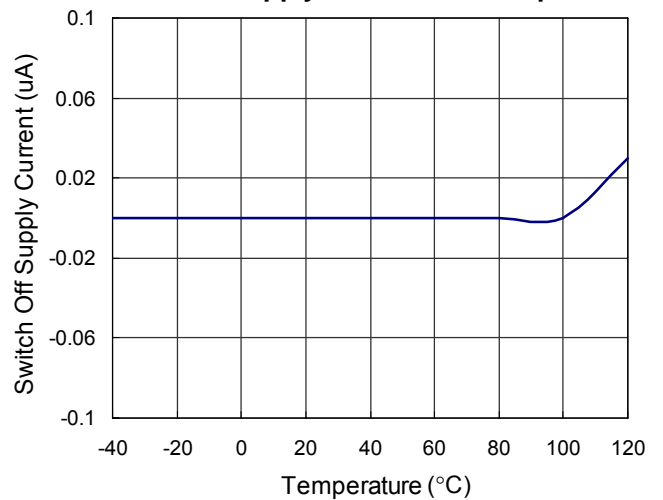

Turn-On Rising Time vs. Temperature

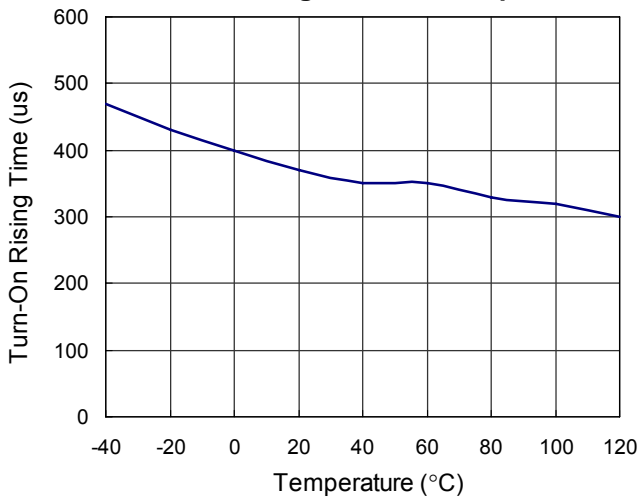

Turn-Off Falling Time vs. Temperature

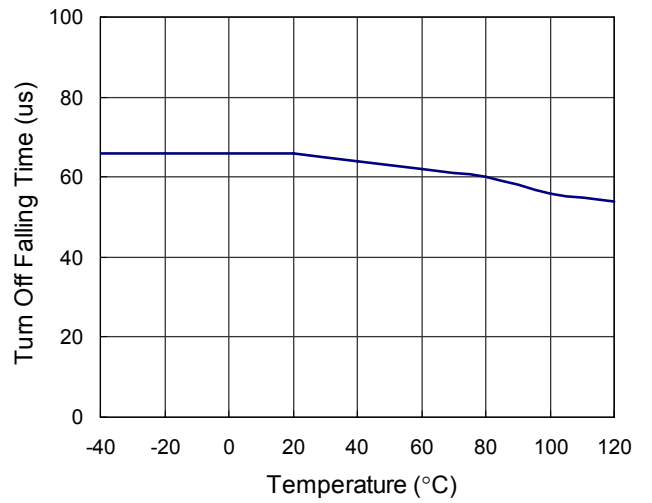

Turn-On Response

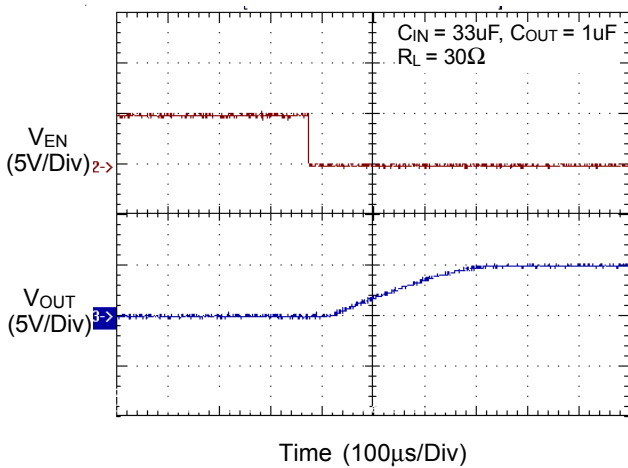

Turn-Off Response

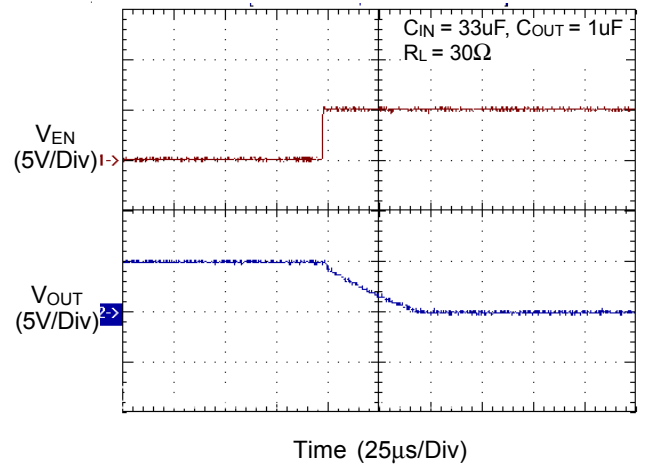

UVLO at Rising

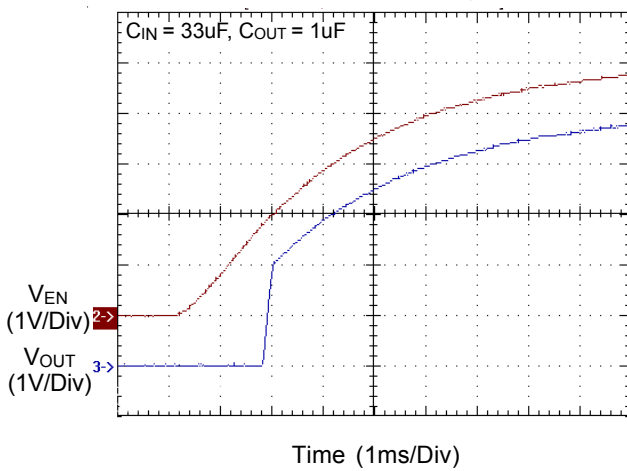

UVLO at Falling

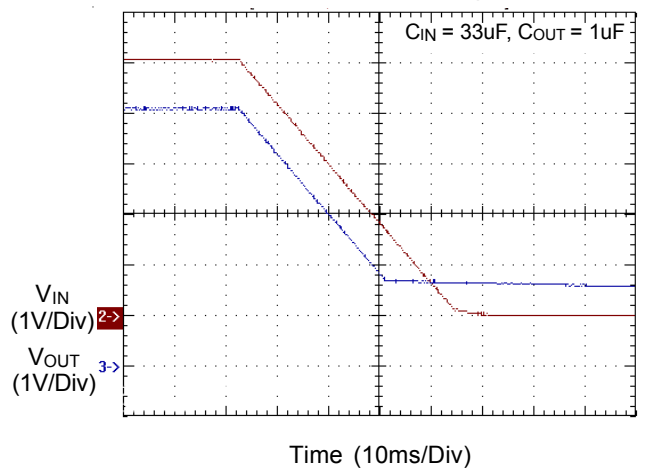



Flag Response with Over Current

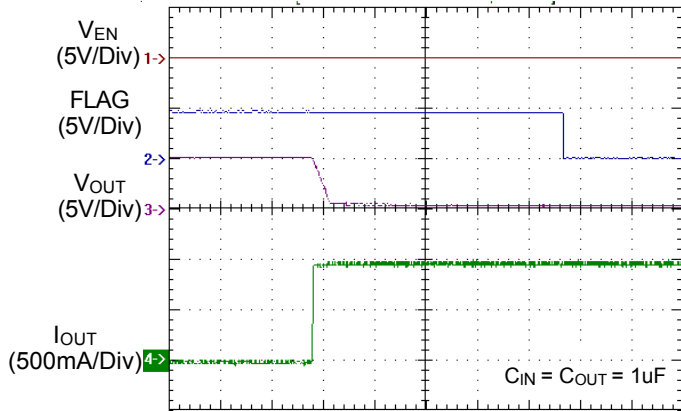

Time (2.5ms/Div)

Flag Response with Turn-On Short Current

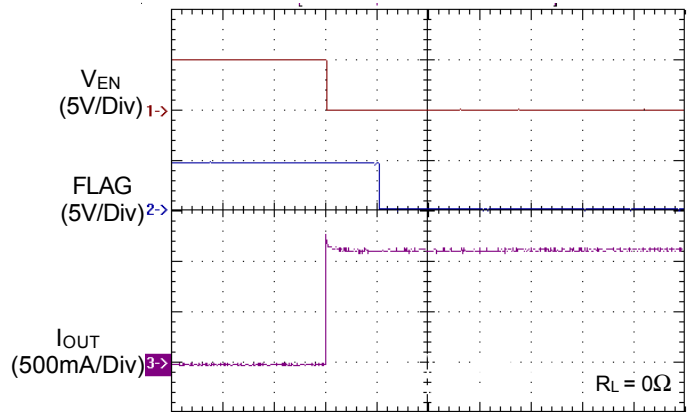

Time (10ms/Div)

Short Circuit Current Response

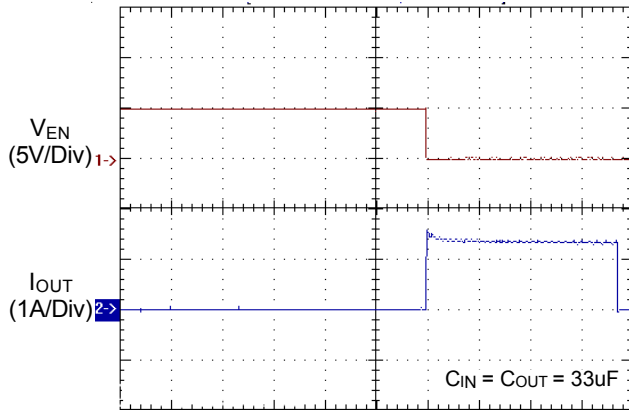

Time (5ms/Div)

Inrush Current Response

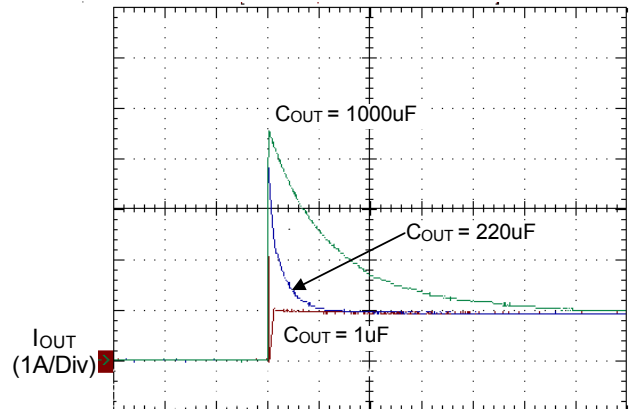

Time (1ms/Div)

Ramped Load Response

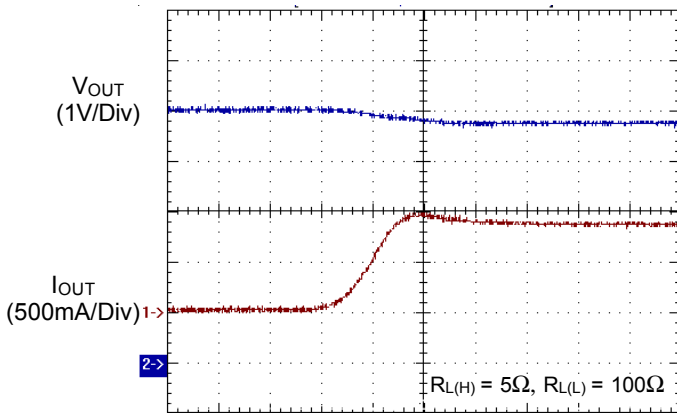

Time (50μs/Div)

Ramped Load Response

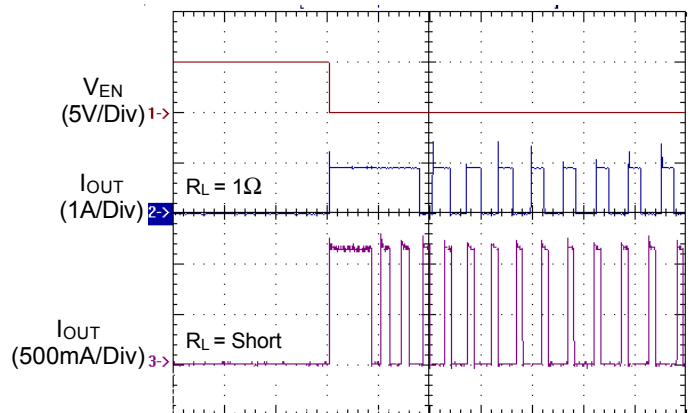

Time (50ms/Div)

**Applications Information**

The RT9706 is a single N-Channel MOSFET high-side power switch with active-low enable input, optimized for self-powered and bus-powered Universal Serial Bus (USB) applications. The RT9706 equipped with a charge pump circuitry to drive the internal NMOS switch; the switch's low  $R_{DS(ON)}$ , 80m $\Omega$ , meets USB voltage drop requirements; and a flag output is available to indicate fault conditions to the local USB controller.

**Input and Output**

$V_{IN}$  (input) is the power source connection to the internal circuitry and the drain of the MOSFET.  $V_{OUT}$  (output) is the source of the MOSFET. In a typical application, current flows through the switch from  $V_{IN}$  to  $V_{OUT}$  toward the load. If  $V_{OUT}$  is greater than  $V_{IN}$ , current will flow from  $V_{OUT}$  to  $V_{IN}$  since the MOSFET is bidirectional when on.

Unlike a normal MOSFET, there is no a parasitic body diode between drain and source of the MOSFET, the RT9706 prevents reverse current flow if  $V_{OUT}$  being externally forced to a higher voltage than  $V_{IN}$  when the output disabled ( $V_{EN} > 2V$ ).

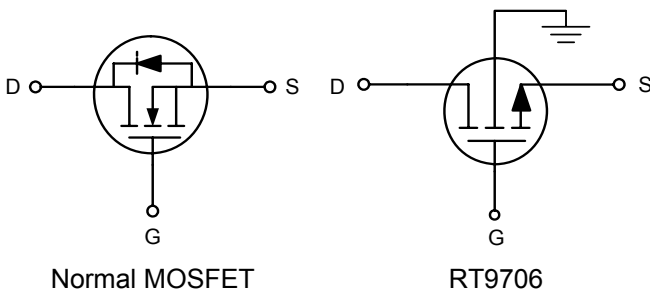

Figure 1

**Chip Enable Input**

The switch will be disabled when the EN pin is in a logic high condition. During this condition, the internal circuitry and MOSFET are turned off, reducing the supply current to 0.1 $\mu$ A typical. The maximum guaranteed voltage for a logic low at the EN pin is 0.8V. A minimum guaranteed voltage of 2V at the EN pin will turn the RT9706 off. Floating the input may cause unpredictable operation. EN should not be allowed to go negative with respect to GND.

**Soft Start for Hot Plug-In Applications**

In order to eliminate the upstream voltage droop caused by the large inrush current during hot-plug events, the "soft-start" feature effectively isolates the power source from extremely large capacitive loads, satisfying the USB voltage droop requirements.

**Fault Flag**

The RT9706 provides a  $\overline{FLG}$  signal pin which is an N-Channel open drain MOSFET output. This open drain output goes low when  $V_{OUT} < V_{IN} - 1V$ , current limit or the die temperature exceeds 130 $^{\circ}$ C approximately. The  $\overline{FLG}$  output is capable of sinking a 10mA load to typically 200mV above ground. The  $\overline{FLG}$  pin requires a pull-up resistor, this resistor should be large in value to reduce energy drain. A 100k $\Omega$  pull-up resistor works well for most applications. In the case of an over-current condition,  $\overline{FLG}$  will be asserted only after the flag response delay time,  $t_D$ , has elapsed. This ensures that  $\overline{FLG}$  is asserted only upon valid over-current conditions and that erroneous error reporting is eliminated. The  $\overline{FLG}$  response delay time  $t_D$  is typically 12ms.

For example, false over-current conditions may occur during hot-plug events when extremely large capacitive loads are connected and causes a high transient inrush current that exceeds the current limit threshold.

**Under-Voltage Lockout**

Under-voltage lockout (UVLO) prevents the MOSFET switch from turning on until input voltage exceeds approximately 1.7V. If input voltage drops below approximately 1.3V, UVLO turns off the MOSFET switch,  $\overline{FLG}$  will be asserted accordingly. Under-voltage detection functions only when the switch is enabled.

**Current Limiting and Short-Circuit Protection**

The current limit circuitry prevents damage to the MOSFET switch and the hub downstream port but can deliver load current up to the current limit threshold of typically 800mA through the switch of RT9706. When a heavy load or short circuit is applied to an enabled switch, a large transient current may flow until the current limit circuitry responds.

Once this current limit threshold is exceeded the device enters constant current mode until the thermal shutdown occurs or the fault is removed.

**Thermal Shutdown**

Thermal shutdown is employed to protect the device from damage if the die temperature exceeds approximately 130°C. If enabled, the switch automatically restarts when the die temperature falls 20°C. The output and  $\overline{FLG}$  signal will continue to cycle on and off until the device is disabled or the fault is removed.

**Power Dissipation and Thermal Consideration**

The device “S” junction temperature depends on several factors such as the load, PCB layout, ambient temperature and package type. The output pin of RT9706 can deliver a current of up to 500mA, respectively over the full operating junction temperature range. However, the maximum output current must be derated at higher ambient temperature to ensure the junction temperature does not exceed 100°C. With all possible conditions, the junction temperature must be within the range specified under operating conditions. Power dissipation can be calculated based on the output current and the  $R_{DS(ON)}$  of switch as below.

$$P_D = R_{DS(ON)} \times (I_{OUT})^2$$

Although the devices are rated for 500mA of output current, but the application may limit the amount of output current based on the total power dissipation and the ambient temperature. The final operating junction temperature for any set of conditions can be estimated by the following thermal equation :

$$P_{D(MAX)} = (T_{J(MAX)} - T_A) / \theta_{JA}$$

$$P_{D(MAX)} = (T_{J(MAX)} - T_A) / \theta_{JA}$$

Where  $T_{J(MAX)}$  is the maximum operation junction temperature,  $T_A$  is the ambient temperature and the  $\theta_{JA}$  is the junction to ambient thermal resistance.

For recommended operating conditions specification of RT9706, where  $T_{J(MAX)}$  is the maximum junction temperature of the die (125°C) and  $T_A$  is the maximum ambient temperature. The junction to ambient thermal resistance  $\theta_{JA}$  is layout dependent. For SOT-23-5 packages, the thermal resistance  $\theta_{JA}$  is 250°C/W on the standard JEDEC 51-3 single-layer thermal test board.

The maximum power dissipation at  $T_A = 25^\circ\text{C}$  can be calculated by following formula :

$$P_{D(MAX)} = (125^\circ\text{C} - 25^\circ\text{C}) / 250^\circ\text{C/W} = 0.4 \text{ W for SOT-23-5 packages}$$

The maximum power dissipation depends on operating ambient temperature for fixed  $T_{J(MAX)}$  and thermal resistance  $\theta_{JA}$ . For RT9706 packages, the Figure 2 of derating curves allows the designer to see the effect of rising ambient temperature on the maximum power allowed.

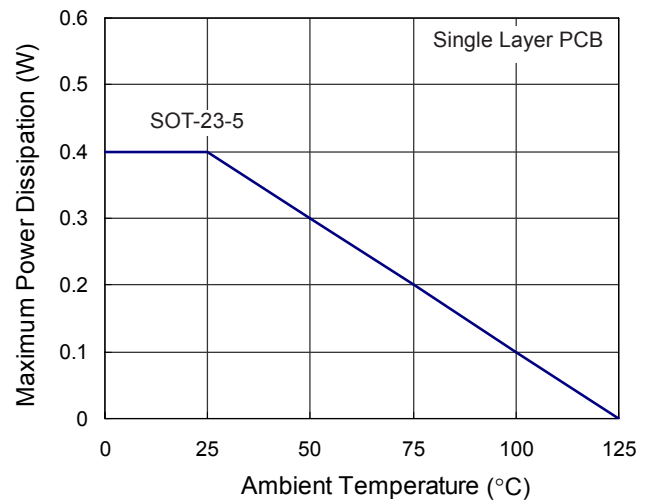

Figure 2. Derating Curves for RT9706 Package

**Universal Serial Bus (USB) & Power Distribution**

The goal of USB is to be enabled device from different vendors to interoperate in an open architecture. USB features include ease of use for the end user, a wide range of workloads and applications, robustness, synergy with the PC industry, and low-cost implementation. Benefits include self-identifying peripherals, dynamically attachable and reconfigurable peripherals, multiple connections (support for concurrent operation of many devices), support for as many as 127 physical devices, and compatibility with PC Plug-and-Play architecture.

The Universal Serial Bus connects USB devices with a USB host: each USB system has one USB host. USB devices are classified either as hubs, which provide additional attachment points to the USB, or as functions, which provide capabilities to the system (for example, a digital joystick). Hub devices are then classified as either Bus-Power Hubs or Self-Powered Hubs.

A Bus-Powered Hub draws all of the power to any internal functions and downstream ports from the USB connector power pins. The hub may draw up to 500mA from the upstream device. External ports in a Bus-Powered Hub can supply up to 100mA per port, with a maximum of four external ports.

Self-Powered Hub power for the internal functions and downstream ports does not come from the USB, although the USB interface may draw up to 100mA from its upstream connect, to allow the interface to function when the remainder of the hub is powered down. The hub must be able to supply up to 500mA on all of its external downstream ports. Please refer to Universal Serial Specification Revision 2.0 for more details on designing compliant USB hub and host systems.

Over-Current protection devices such as fuses and PTC resistors (also called polyfuse or polyswitch) have slow trip times, high on-resistance, and lack the necessary circuitry for USB-required fault reporting.

The faster trip time of the RT9706 power distribution allow designers to design hubs that can operate through faults. The RT9706 have low on-resistance and internal fault-reporting circuitry that help the designer to meet voltage regulation and fault notification requirements.

Because the devices are also power switches, the designer of self-powered hubs has the flexibility to turn off power to output ports. Unlike a normal MOSFET, the devices have controlled rise and fall times to provide the needed inrush current limiting required for the bus-powered hub power switch.

### Supply Filter/Bypass Capacitor

A 1μF low-ESR ceramic capacitor from  $V_{IN}$  to GND, located at the device is strongly recommended to prevent the input voltage drooping during hot-plug events. However, higher capacitor values will further reduce the voltage droop on the input. Furthermore, without the bypass capacitor, an output short may cause sufficient ringing on the input (from source lead inductance) to destroy the internal control circuitry. The input transient must not exceed 6.5V of the absolute maximum supply voltage even for a short duration.

### Output Filter Capacitor

A low-ESR 150μF aluminum electrolytic or tantalum between  $V_{OUT}$  and GND is strongly recommended to meet the 330mV maximum droop requirement in the hub  $V_{BUS}$  (Per USB 2.0, output ports must have a minimum 120μF of low-ESR bulk capacitance per hub). Standard bypass methods should be used to minimize inductance and resistance between the bypass capacitor and the downstream connector to reduce EMI and decouple voltage droop caused when downstream cables are hot-insertion transients. Ferrite beads in series with  $V_{BUS}$ , the ground line and the 0.1μF bypass capacitors at the power connector pins are recommended for EMI and ESD protection. The bypass capacitor itself should have a low dissipation factor to allow decoupling at higher frequencies.

### Fault Flag Filtering (Optional)

The transient inrush current to downstream capacitance may cause a short-duration error flag, which may cause erroneous over-current reporting. A simple 1ms RC low-pass filter (10kΩ and 0.1μF) in the flag line (see Typical Application Circuit) eliminates short-duration transients.

### Voltage Drop

The USB specification states a minimum port-output voltage in two locations on the bus, 4.75V out of a Self-Powered Hub port and 4.4V out of a Bus-Powered Hub port. As with the Self-Powered Hub, all resistive voltage drops for the Bus-Powered Hub must be accounted for to guarantee voltage regulation (see Figure 7-47 of Universal Serial Specification Revision 2.0 ).

The following calculation determines  $V_{OUT(MIN)}$  for multiple ports ( $N_{PORTS}$ ) ganged together through one switch (if using one switch per port,  $N_{PORTS}$  is equal to 1) :

$$V_{OUT(MIN)} = 4.75V - [ I_I \times ( 4 \times R_{CONN} + 2 \times R_{CABLE} ) ] - (0.1A \times N_{PORTS} \times R_{SWITCH} ) - V_{PCB}$$

Where

$R_{CONN}$  : Resistance of connector contacts  
(two contacts per connector)

$R_{CABLE}$  : Resistance of upstream cable wires  
(one 5V and one GND)

$R_{SWITCH}$  : Resistance of power switch  
(80mΩ typical for RT9706)

$V_{PCB}$  : PCB voltage drop

The USB specification defines the maximum resistance per contact ( $R_{CONN}$ ) of the USB connector to be 30mΩ and the drop across the PCB and switch to be 100mV. This basically leaves two variables in the equation : the resistance of the switch and the resistance of the cable. If the hub consumes the maximum current ( $I_H$ ) of 500mA, the maximum resistance of the cable is 90mΩ.

The resistance of the switch is defined as follows :

$$R_{SWITCH} = \{ 4.75V - 4.4V - [ 0.5A \times ( 4 \times 30m\Omega + 2 \times 90m\Omega ) ] - V_{PCB} \} \div ( 0.1A \times N_{PORTS} )$$

$$= (200mV - V_{PCB} ) \div ( 0.1A \times N_{PORTS} )$$

If the voltage drop across the PCB is limited to 100mV, the maximum resistance for the switch is 250mΩ for four ports ganged together. The RT9706, with its maximum 100mΩ on-resistance over temperature, easily meets this requirement.

**PCB Layout**

In order to meet the voltage drop, droop, and EMI requirements, careful PCB layout is necessary. The following guidelines must be considered :

- Keep all  $V_{BUS}$  traces as short as possible and use at least 50-mil, 2 ounce copper for all  $V_{BUS}$  traces.
- Avoid vias as much as possible. If vias are necessary, make them as large as feasible.
- Place a ground plane under all circuitry to lower both resistance and inductance and improve DC and transient performance (Use a separate ground and power plans if possible).
- Place cuts in the ground plane between ports to help reduce the coupling of transients between ports.
- Locate the output capacitor and ferrite beads as close to the USB connectors as possible to lower impedance (mainly inductance) between the port and the capacitor and improve transient load performance.
- Locate the RT9706 as close as possible to the output port to limit switching noise.

- Locate the ceramic bypass capacitors as close as possible to the  $V_{IN}$  pins of the RT9706.

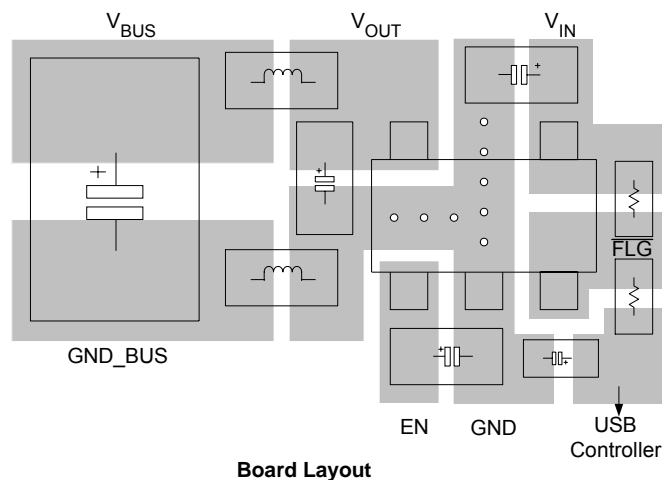

**ESD**

Because USB is a hot insertion and removal system, USB components (especially the connector pins) are subject to electrostatic discharge (ESD) and should be qualified to IEC801.2. The RT9706 is designed to withstand a 8kV human body mode, as defined in MIL-STD-883C. The requirements in IEC801.2 are much more stringent and require additional capacitors for the RT9706 to withstand the higher ESD energy.

Low-ESR 1μF ceramic bypass capacitors and output capacitors should be placed as closely as possible to the  $V_{IN}$  and  $V_{OUT}$  pins to increase the ESD immunity. The RT9706 may pass the requirements of IEC 1000-4-2 (EN 50082-1) level-4 for 15kV air discharge and 8kV contact discharge tests when these capacitors are added.

Outline Dimension

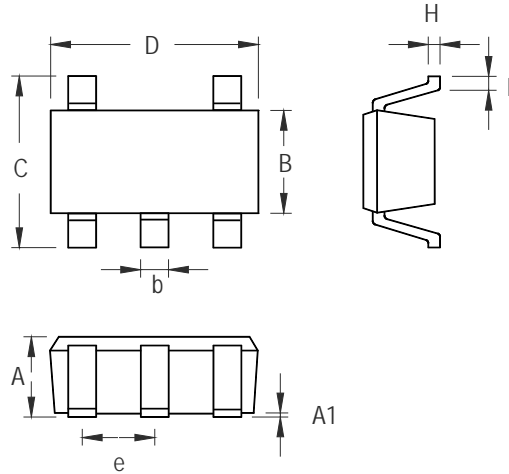

Symbol	Dimensions In Millimeters		Dimensions In Inches	
	Min	Max	Min	Max
A	0.889	1.295	0.035	0.051
A1	0.000	0.152	0.000	0.006
B	1.397	1.803	0.055	0.071
b	0.356	0.559	0.014	0.022
C	2.591	2.997	0.102	0.118
D	2.692	3.099	0.106	0.122
e	0.838	1.041	0.033	0.041
H	0.080	0.254	0.003	0.010
L	0.300	0.610	0.012	0.024

SOT-23-5 Surface Mount Package

**Richtek Technology Corporation**

Headquarter  
 5F, No. 20, Taiyuen Street, Chupei City  
 Hsinchu, Taiwan, R.O.C.  
 Tel: (8863)5526789 Fax: (8863)5526611

**Richtek Technology Corporation**

Taipei Office (Marketing)  
 8F, No. 137, Lane 235, Paochiao Road, Hsintien City  
 Taipei County, Taiwan, R.O.C.  
 Tel: (8862)89191466 Fax: (8862)89191465  
 Email: marketing@richtek.com