

RURG1520CC

15A, 200V Ultrafast Dual Diode

Features

- Ultrafast with Soft Recovery.....<30ns
- Operating Temperature 175°C
- Reverse Voltage.....200V
- Avalanche Energy Rated
- Planar Construction

Applications

- Switching Power Supplies
- Power Switching Circuits
- General Purpose

Ordering Informations

Part Number	Package	Brand
RURG1520CC	TO-247	RURG1520C

Note: When ordering, use the entire part number.

Description

The RURG1520CC is an ultrafast dual diode with soft recovery characteristics ($t_{rr}<30ns$). It has low forward voltage drop and is of silicon nitride passivated ion-implanted epitaxial planar construction.

This device is intended for use as a freewheeling/clamping diode and rectifier in a variety of switching power supplies and other power switching applications. Its low stored charge and ultrafast recovery with soft recovery characteristic minimizes ringing and electrical noise in many power switching circuits, reducing power loss in the switching transistors.

Formerly developmental type TA09926.

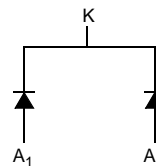
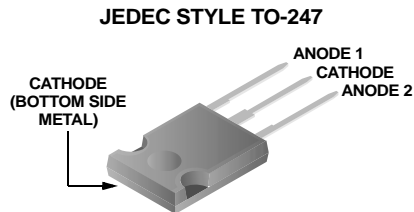

Absolute Maximum Ratings (Per Leg) $T_C = 25^\circ C$

Symbol	Parameter	RURG1520C	Units
V_{RRM}	Peak Repetitive Reverse Voltage	200	V
V_{RWM}	Working Peak Reverse Voltage	200	V
V_R	DC Blocking Voltage	200	V
$I_{F(AV)}$	Average Rectified Forward Current ($T_C = 157^\circ C$)	15	A
I_{FRM}	Repetitive Peak Surge Current (Square Wave, 20kHz)	30	A
I_{FSM}	Nonrepetitive Peak Surge Current (Halfwave, 1 phase, 60Hz)	200	A
P_D	Maximum Power Dissipation	100	W
E_{AVL}	Avalanche Energy (See Figures 8 and 9)	20	mJ
T_{STG}, T_J	Operating and Storage Temperature	-65 to 175	$^\circ C$

Electrical Characteristics (Per Leg) $T_C = 25^\circ\text{C}$, unless otherwise specified

Symbol	Parameter	Test Conditions	Min.	Typ.	Max.	Units
V_F	Forward Voltage	$I_F = 15\text{A}$			1.05	V
		$I_F = 15\text{A}, T_C = 150^\circ\text{C}$			0.85	V
I_R	Reverse Leakage	$V_R = 200\text{V}$			100	μA
		$V_R = 200\text{V}, T_C = 150^\circ\text{C}$			500	μA
t_{rr}	Reverse Recovery Time	$I_F = 1\text{A}, dI_F/dt = 100\text{A}/\mu\text{s}$			30	ns
		$I_F = 15\text{A}, dI_F/dt = 100\text{A}/\mu\text{s}$			35	ns
t_a		$I_F = 15\text{A}, dI_F/dt = 100\text{A}/\mu\text{s}$		20		ns
t_b		$I_F = 15\text{A}, dI_F/dt = 100\text{A}/\mu\text{s}$		10		ns
$R_{\theta JC}$					1.5	$^\circ\text{C}/\text{W}$

DEFINITIONS

V_F = Instantaneous forward voltage (pw = 300 μs , D = 2%)

I_R = Instantaneous reverse current.

t_{rr} = Reverse recovery time (See Figure 6), summation of $t_a + t_b$.

t_a = Time to reach peak reverse current (See Figure 6).

t_b = Time from peak I_{RM} to projected zero crossing of I_{RM} based on a straight line from peak I_{RM} through 25% of I_{RM} (See Figure 6).

$R_{\theta JC}$ = Thermal resistance junction to case.

pw = pulse width.

D = duty cycle

Typical Performance Curves

Figure 1. Forward Current vs Forward Voltage

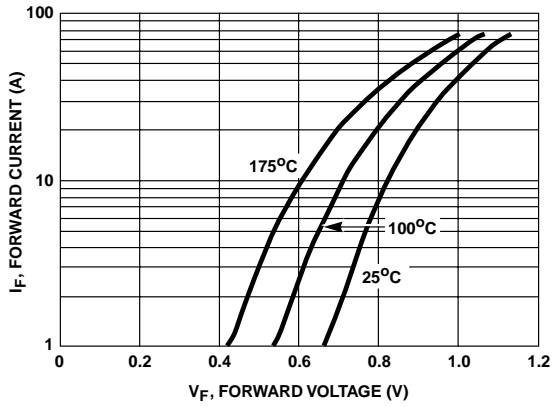

Figure 2. Reverse Current vs Reverse Voltage

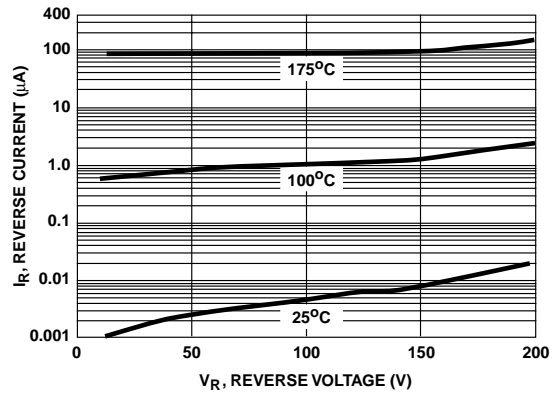

Figure 3. t_{rr} , t_a and t_b Curves vs Forward Current

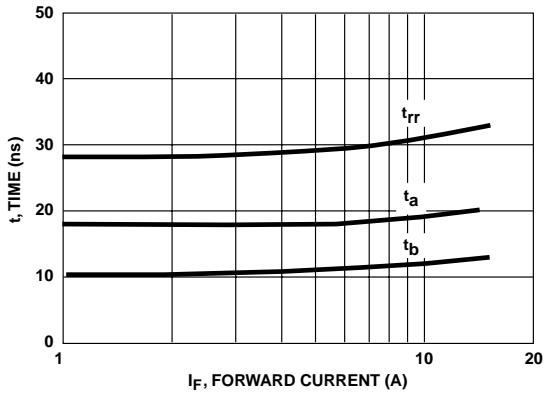
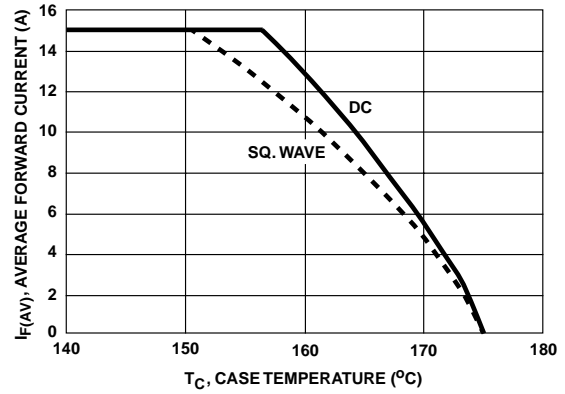

Figure 4. Current Derating Curve



Test Circuits and Waveforms

Figure 5. t_{rr} Test Circuit

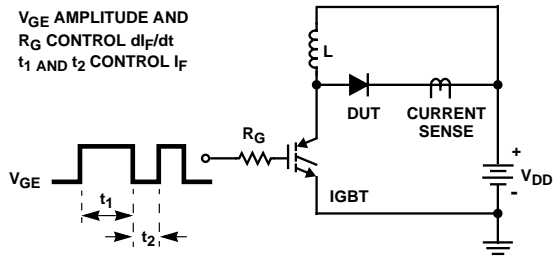

Figure 6. t_{rr} Waveforms and Definitions

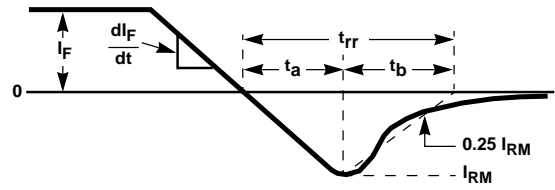

Figure 7. Avalanche Energy Test Circuit

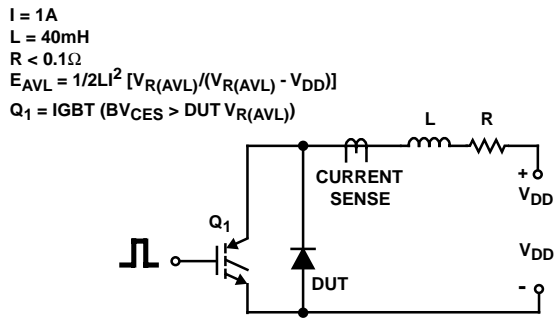
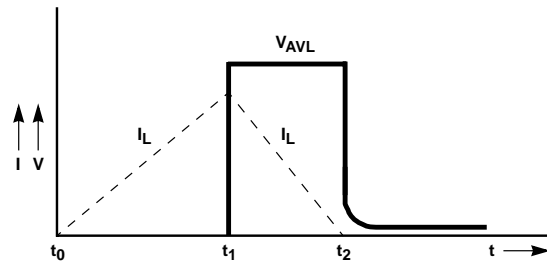

Figure 8. Avalanche Current and Voltage Waveforms



TRADEMARKS

The following are registered and unregistered trademarks Fairchild Semiconductor owns or is authorized to use and is not intended to be an exhaustive list of all such trademarks.

ACE ^x ™	FAST [®]	IntelliMAX™	POP™	SPM™
ActiveArray™	FAST ^r ™	ISOPANAR™	Power247™	Stealth™
Bottomless™	FPS™	LittleFET™	PowerEdge™	SuperFET™
CoolFET™	FRFET™	MICROCOUPLER™	PowerSaver™	SuperSOT™-3
CROSSVOLT™	GlobalOptoisolator™	MicroFET™	PowerTrench [®]	SuperSOT™-6
DOME™	GTO™	MicroPak™	QFET [®]	SuperSOT™-8
EcoSPARK™	HiSeC™	MICROWIRE™	QS™	SyncFET™
E ² CMOST™	I ² C™	MSX™	QT Optoelectronics™	TinyLogic [®]
EnSigna™	<i>i-Lo</i> ™	MSXPro™	Quiet Series™	TINYOPTO™
FACT™	ImpliedDisconnect™	OCX™	RapidConfigure™	TruTranslation™
FACT Quiet Series™		OCXPro™	RapidConnect™	UHC™
Across the board. Around the world.™		OPTOLOGIC [®]	μ SerDes™	UltraFET [®]
The Power Franchise [®]		OPTOPLANAR™	SILENT SWITCHER [®]	UniFET™
Programmable Active Droop™		PACMAN™	SMART START™	VCX™

DISCLAIMER

FAIRCHILD SEMICONDUCTOR RESERVES THE RIGHT TO MAKE CHANGES WITHOUT FURTHER NOTICE TO ANY PRODUCTS HEREIN TO IMPROVE RELIABILITY, FUNCTION OR DESIGN. FAIRCHILD DOES NOT ASSUME ANY LIABILITY ARISING OUT OF THE APPLICATION OR USE OF ANY PRODUCT OR CIRCUIT DESCRIBED HEREIN; NEITHER DOES IT CONVEY ANY LICENSE UNDER ITS PATENT RIGHTS, NOR THE RIGHTS OF OTHERS.

LIFE SUPPORT POLICY

FAIRCHILD'S PRODUCTS ARE NOT AUTHORIZED FOR USE AS CRITICAL COMPONENTS IN LIFE SUPPORT DEVICES OR SYSTEMS WITHOUT THE EXPRESS WRITTEN APPROVAL OF FAIRCHILD SEMICONDUCTOR CORPORATION.

As used herein:

1. Life support devices or systems are devices or systems which, (a) are intended for surgical implant into the body, or (b) support or sustain life, or (c) whose failure to perform when properly used in accordance with instructions for use provided in the labeling, can be reasonably expected to result in significant injury to the user.
2. A critical component is any component of a life support device or system whose failure to perform can be reasonably expected to cause the failure of the life support device or system, or to affect its safety or effectiveness.

PRODUCT STATUS DEFINITIONS

Definition of Terms

Datasheet Identification	Product Status	Definition
Advance Information	Formative or In Design	This datasheet contains the design specifications for product development. Specifications may change in any manner without notice.
Preliminary	First Production	This datasheet contains preliminary data, and supplementary data will be published at a later date. Fairchild Semiconductor reserves the right to make changes at any time without notice in order to improve design.
No Identification Needed	Full Production	This datasheet contains final specifications. Fairchild Semiconductor reserves the right to make changes at any time without notice in order to improve design.
Obsolete	Not In Production	This datasheet contains specifications on a product that has been discontinued by Fairchild semiconductor. The datasheet is printed for reference information only.

Rev. I15