



LC SERIES RECEIVER MODULE DATA GUIDE

Covers Ultra-Compact S-Style (True SMD Version)

DESCRIPTION

The LC Series is ideally suited for volume use in OEM applications such as remote control, security, identification, and periodic data transfer. Available in 2 styles of compact SMD packages, the LC-S receiver utilizes a highly optimized SAW architecture to achieve an unmatched blend of performance, size, efficiency and cost. When paired with a matching LC Series transmitter, a highly reliable wireless link is formed, capable of transferring serial data at distances in excess of 300 feet. No external RF components, except an antenna, are required, making design integration straightforward.

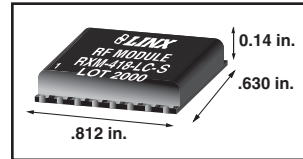

PHYSICAL DIMENSIONS

TOP VIEW			
1	NC	ANT	16
2	NC	GND	15
3	NC	NC	14
4	GND	NC	13
5	VCC	NC	12
6	PDN	NC	11
7	NC	NC	10
8	DATA	NC	9

PINOUTS

FEATURES

- Low Cost
- No External RF Components Required
- Low Power Consumption
- Compact True Surface-Mount Package
- Stable SAW-based Architecture
- Outstanding Sensitivity
- Supports Data Rates to 5,000bps
- Direct Serial Interface
- No Production Tuning

APPLICATIONS INCLUDE

- Remote control / Keyless entry
- Garage / Gate openers
- Lighting control
- Medical monitoring / Call systems
- Remote industrial monitoring
- Periodic data transfer
- Home / Industrial automation
- Fire / Security alarms
- Wire Elimination
- Long-range RFID

ORDERING INFORMATION

PART #	DESCRIPTION
EVAL-***-LC	Basic Evaluation Kit
MDEV-***-LC	Master Development Kit
RXM-315-LC-P	Receiver 315MHZ (Pinned SMD)
RXM-418-LC-P	Receiver 418MHZ (Pinned SMD)
RXM-433-LC-P	Receiver 433MHZ (Pinned SMD)
RXM-315-LC-S	Receiver 315MHZ (SMD)
RXM-418-LC-S	Receiver 418MHZ (SMD)
RXM-433-LC-S	Receiver 433MHZ (SMD)
*** Insert Frequency	
■ Not covered in this manual	

LC Receivers are supplied in tube packaging - 40 pcs. per tube.

PERFORMANCE DATA–RXM-***-LC

ABOUT THESE MEASUREMENTS

The performance parameters listed below are based on module operation at 25°C from a 3VDC. Figure 1 at the right illustrates the connections necessary for testing and operation. It is recommended that all ground pads be connected to the groundplane. The pads marked NC have no physical connection and are designed only to add support.

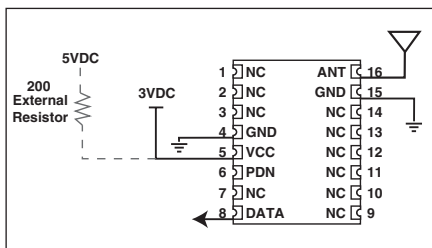

Figure 1: Test/Basic Application Circuit

ABSOLUTE MAXIMUM RATINGS

Supply voltage V_{CC}	-0.3	to	+4.2	VDC
	-0.3	to	+5.2	VDC (SEE NOTES 3,4)
Operating temperature	-30°C	to	+70°C	
Storage temperature	-45°C	to	+85°C	
Soldering temperature	+225°C for 10 sec.			
RF input, pin 16	0 dBm			
Any input or output pin	-0.3	to	V_{CC}	

NOTE Exceeding any of the limits of this section may lead to permanent damage to the device. Furthermore, extended operation at these maximum ratings may reduce the life of this device.

Parameters RXM-315-LC-S	Designation	Min.	Typical	Max.	Units	Notes
Operating Voltage	V_{CC}	2.7	–	4.2	VDC	–
w/Dropping Resistor	V_{CC}	4.7	–	5.2	VDC	3
Current Continuous	$I_{CC} (V_{CC}=3V)$	4.0	5.0	7.0	mA	–
Current in Sleep	$I_{SLP} (V_{CC}=3V)$	–	700	930	μA	–
Data Out Voltage Logic Low	V_{OL}	0	–	0.2	VDC	–
Data Out Voltage Logic High	V_{OH}	$V_{CC}-0.3$	–	V_{CC}	VDC	–
	V_{OH}	2.7	3.4	V_{CC} (Note 5)	VDC	4
Receive Frequency	F_C	314.925	315.0	315.075	MHz	–
Noise BW		–	280	–	kHz	–
Sensitivity @10 ⁻⁵ BER		-92	-95	-100	dBm	1
Baud Rate		100	–	5,000	bps	–
Settling Time		5	7	10	mSec	2

Parameters RXM-418-LC-S	Designation	Min.	Typical	Max.	Units	Notes
Operating Voltage	V_{CC}	2.7	–	4.2	VDC	–
w/Dropping Resistor	V_{CC}	4.7	–	5.2	VDC	3
Current Continuous	$I_{CC} (V_{CC}=3V)$	4.0	5.0	7.0	mA	–
Current in Sleep	$I_{SLP} (V_{CC}=3V)$	–	700	930	μA	–
Data Out Voltage Logic Low	V_{OL}	0	–	0.2	VDC	–
Data Out Voltage Logic High	V_{OH}	$V_{CC}-0.3$	–	V_{CC}	VDC	–
	V_{OH}	2.7	3.4	V_{CC} (Note 5)	VDC	4
Receive Frequency	F_C	417.925	418	418.075	MHz	–
Noise BW		–	280	–	kHz	–
Sensitivity @10 ⁻⁵ BER		-92	-95	-100	dBm	1
Baud Rate		100	–	5,000	bps	–
Settling Time		5	7	10	mSec	2

Parameters RXM-433-LC-S	Designation	Min.	Typical	Max.	Units	Notes
Operating Voltage	V_{CC}	2.7	–	4.2	VDC	–
w/Dropping Resistor	V_{CC}	4.7	–	5.2	VDC	3
Current Continuous	$I_{CC} (V_{CC}=3V)$	4.0	5.0	7.0	mA	–
Current in Sleep	$I_{SLP} (V_{CC}=3V)$	–	700	930	μA	–
Data Out Voltage Logic Low	V_{OL}	0	–	0.2	VDC	–
Data Out Voltage Logic High	V_{OH}	$V_{CC}-0.3$	–	V_{CC}	VDC	–
	V_{OH}	2.7	3.4	V_{CC} (Note 5)	VDC	4
Receive Frequency	F_C	433.845	433.92	433.995	MHz	–
Noise BW		–	280	–	kHz	–
Sensitivity @10 ⁻⁵ BER		-92	-95	-100	dBm	1
Baud Rate		100	–	5,000	bps	–
Settling Time		5	7	10	mSec	2

Notes:

- For BER of 10⁻⁵ at 4800 baud. Sensitivity is affected by antenna SWR. See Figure 3.
- Time to valid data output.
- *CRITICAL*** In order to operate the device over this range it is necessary for a 200 resistor to be placed in-line with VCC.
- When operating from a 5 volt source it is important to consider that the output will swing to well less than 5 volts as a result of the required dropping resistor. Please verify that the minimum voltage will meet the high threshold requirement of the device to which data is being sent.
- Maximum output voltage measured after in-line dropping resistor.

PHYSICAL PACKAGING

The receiver is packaged as a hybrid SMD module with sixteen pads spaced 0.100" on center. The castellated SMD package allows for easy prototyping or hand assembly while maintaining full compatibility with automated pick-and-place equipment. Modules are supplied in tube packaging.

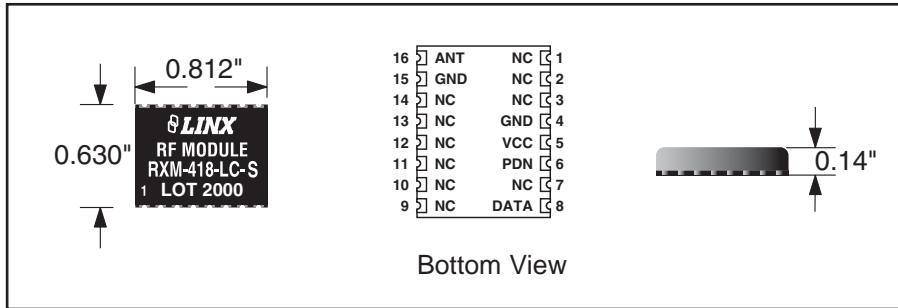

Figure 2: LC-S Series Receiver Package Dimensions

PIN DESCRIPTIONS:

Pin 1, 2, 3, 7, 9, 10, 11, 12, 13, 14 - NO CONNECTION

Attach to an isolated pad to provide support for the module. Do not make any electrical connection.

Pin 4, 15 - GROUND

Connect to quiet ground or groundplane. It is internally connected to pin 8.

Pin 5 - POSITIVE SUPPLY (V_{CC} 2.7 - 4.2 VDC *4.7 - 5.2 w/ external drooping resistor)

The supply must be clean (<20mVpp), stable and free of high-frequency noise. A supply filter is recommended unless the module is operated from its own regulated supply or battery. Please note that operation from 4.7 to 5.2 volts requires the use of an external 200 resistor placed in series with V_{CC} .

Pin 6 - POWER DOWN

Pull this line low to put the receiver in sleep mode (700 μ A). Leave floating or pull high to enable the receiver.

Pin 8 - DATA OUT

Internally pulled to V_{CC} . Open collector data output with internal pullup to V_{CC} . Recovered data is output on this pin. Output voltage during a high bit will average $V_{CC} - 0.3V$.

Pin 16 - RF IN

The receiver antenna connects to this input. It has nominal RF impedance of 50 and is capacitively isolated from the internal circuitry.

TYPICAL PERFORMANCE GRAPHS

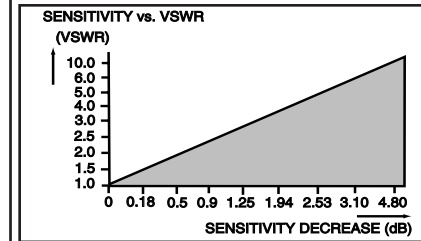

Figure 3: Sensitivity vs. VSWR

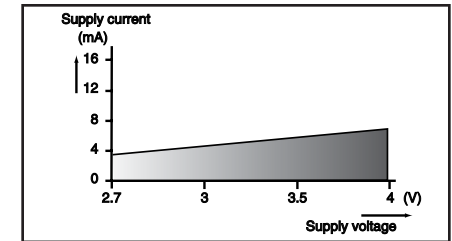

Figure 4: Consumption vs. Supply Voltage

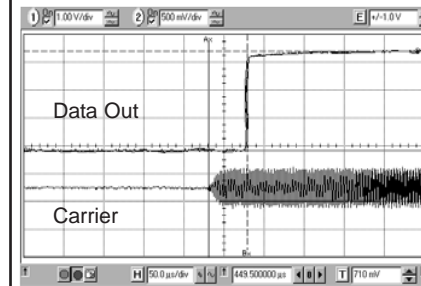

Figure 5: RF in vs. Receiver Response Time

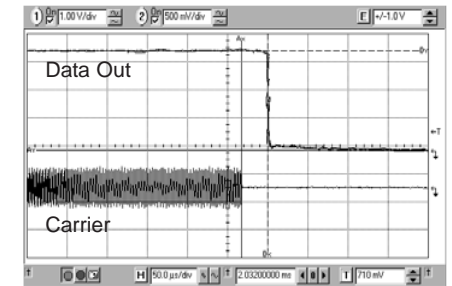

Figure 6: Typical Receiver Turn-Off Time

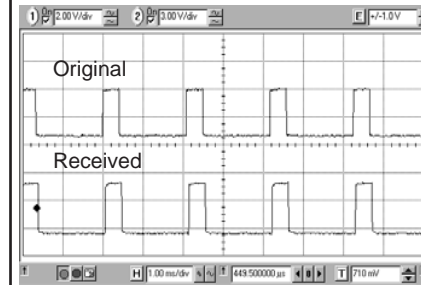

Figure 7: Original vs. Received Data
4,800bps 20% Duty Cycle

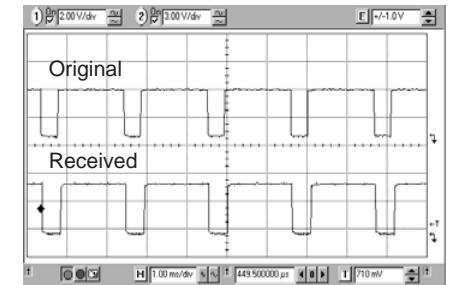

Figure 8: Original vs. Received Data
4,800bps 80% Duty Cycle

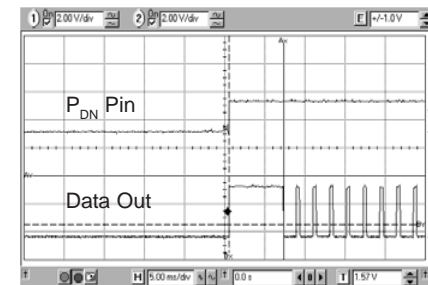

Figure 9: Power-On Settling Time
(Time to Valid Data)

PRODUCTION GUIDELINES

The LC modules are packaged in a hybrid SMD package that supports hand- or automated-assembly techniques. Since LC devices contain discrete components internally, the assembly procedures are critical to ensuring the reliable function of the LC product. The following procedures should be reviewed with and practiced by all assembly personnel.

PAD LAYOUT

The following pad layout diagrams are designed to facilitate both hand and automated assembly.

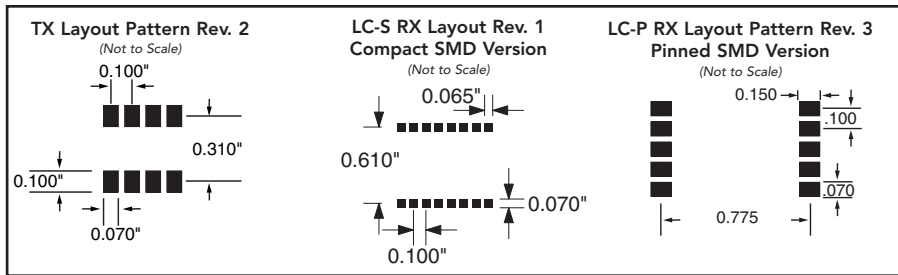

Figure 10: Recommended Pad Layout

RECEIVER HAND ASSEMBLY

The LC-S Receiver's primary mounting surface is sixteen pads located on the bottom of the module. Since these pads are inaccessible during mounting, castellations that run up the side of the module have been provided to facilitate solder wicking to the module's underside. If the recommended pad placement has been followed, the pad on the board will extend slightly past the edge of the module. Touch both the PCB pad and the module castellation with a fine soldering tip. Tack one module corner first, then work around the remaining attachment points using care not to exceed the times listed below.

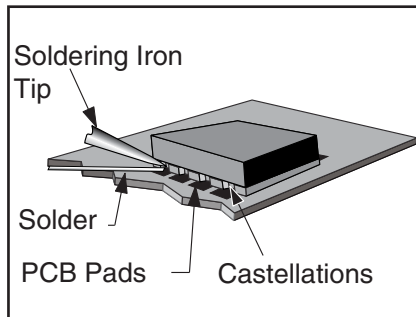

Figure 11: LC-S Soldering Technique

AUTOMATED ASSEMBLY

For high-volume assembly most users will want to auto-place the modules. The receivers have been designed to maintain compatibility with reflow processing techniques; however, due to the module's hybrid nature certain aspects of the assembly process are far more critical than for other component types.

Following are brief discussions of the three primary areas where caution must be observed.

Reflow Temperature Profile

The single most critical stage in the automated assembly process is the reflow process. The reflow profile below should be closely followed since excessive temperatures or transport times during reflow will irreparably damage the modules. Assembly personnel will need to pay careful attention to the oven's profile to ensure that it meets the requirements necessary to successfully reflow all components while still meeting the limits mandated by the modules themselves.

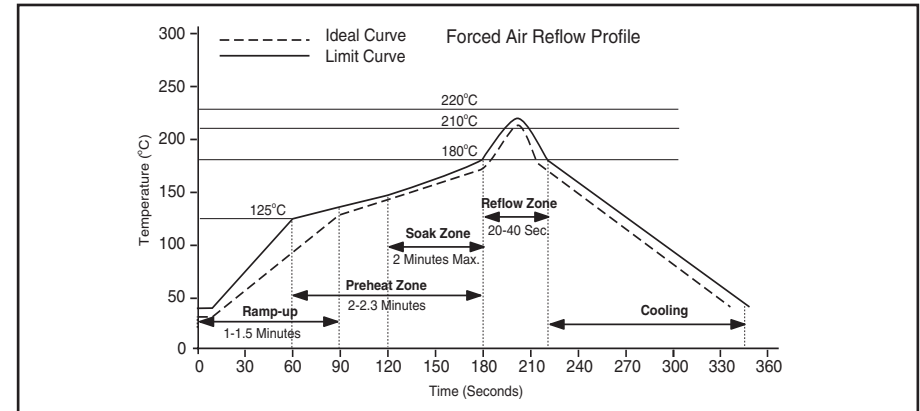

Figure 12: Required Reflow Profile

Revision 2 - 11/98

Shock During Reflow Transport

Since some internal module components may reflow along with the components placed on the board being assembled, it is imperative that the module not be subjected to shock or vibration during the time solder is liquidus.

Washability

The modules are wash resistant, but are not hermetically sealed. They may be subject to a standard wash cycle; however, a twenty-four-hour drying time should be allowed before applying electrical power to the modules. This will allow any moisture that has migrated into the module to evaporate, thus eliminating the potential for shorting during power-up or testing.

Absolute Maximum Solder Times

Hand-Solder Temp. TX +225°C for 10 Sec.

Hand-Solder Temp. RX +225°C for 10 Sec.

Recommended Solder Melting Point +180°C

Reflow Oven: +220° Max. (See adjoining diagram)

MODULE DESCRIPTION

The RXM-LC-S is a low-cost, high-performance Surface Acoustic Wave (SAW) based Carrier-Present Carrier-Absent (CPCA) receiver, capable of receiving serial data at up to 5,000 bits/second. Its exceptional sensitivity provides outstanding range at the maximum data rate. While oriented toward high-volume automated production, the LC-S's compact surface-mount package is also friendly to prototype and hand production. When combined with a Linx LC series transmitter, a highly reliable RF link capable of transferring digital data over line-of-sight distances in excess of 300 feet (90m) is formed.

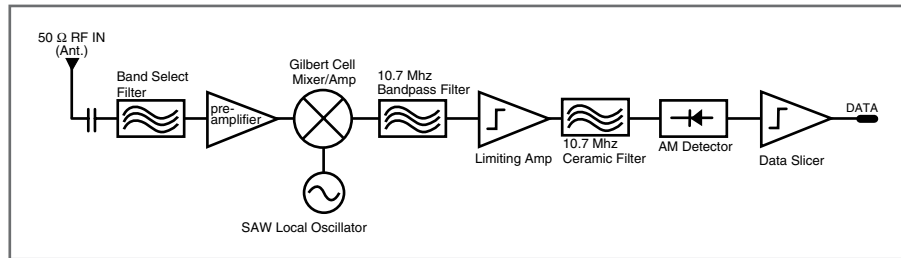

Figure 13: LC Series Receiver Block Diagram

THEORY OF OPERATION

The RXM-LC-S is designed to recover data sent by a CPCA transmitter. This type of AM modulation is often referred to by other designations including CW and OOK. As the CPCA designation suggests, this type of modulation represents a logic low '0' by the absence of a carrier and a logic high '1' by the presence of a carrier. This modulation method affords numerous benefits. Two most important are: 1) Cost-effectiveness due to design simplicity and 2) Higher output power and thus greater range in countries (such as the US) which average output power measurements over time. Please refer to Linx application note #00130 for a further discussion of modulation techniques including CPCA.

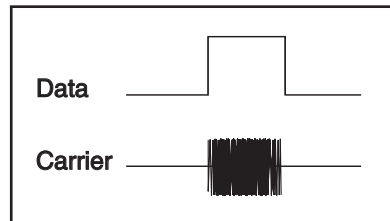

Figure 14: CPCA (AM) Modulation

The LC series utilizes an advanced single-conversion superhet design which incorporates a SAW device, high IF frequency and multi-layer ceramic filters. The SAW device has been in use for more than a decade but has only recently begun to receive the widespread acclaim its outstanding capabilities deserve. A SAW device provides a highly accurate frequency source with excellent immunity to frequency shift due to age or temperature. The use of SAW devices in both the LC transmitter and receiver modules allows the receiver's pass opening to be quite narrow, thus increasing sensitivity and reducing susceptibility to near-band interference. The quality of components and overall architecture utilized in the LC series is unusual in a low-cost product and is one of the primary reasons the LC receivers are able to outperform even far more expensive products.

POWER SUPPLY REQUIREMENTS

The receiver module requires a clean, well-regulated power source. While it is preferable to power the unit from a battery, the unit can also be operated from a power supply as long as noise and 'hash' is less than 20 mV. A 10 resistor in series with the supply followed by a 10µF tantalum capacitor from V_{CC} to ground will help in cases where the quality of supply power is poor. Please note that operation from 4.7 to 5.2 volts requires the use of an external 200 resistor placed in series with V_{CC} .

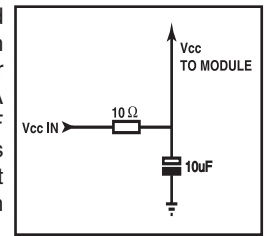

Figure 15: Supply Filter

THE DATA OUTPUT

A CMOS-compatible data output is available on pin 8. This output is normally used to drive directly a digital decoder IC or a microprocessor that is performing the data decoding. The receiver's output is internally qualified, meaning that it will only transition when valid data is present. In instances where no carrier is present the output will remain low. Since a UART utilizes high marking to indicate the absence of data, a designer using a UART may wish to insert a logic inverter between the data output of the RXM-LC-S and the UART.

It is important to realize that the data output of the receiver may be subject to some pulse stretching or shortening. This is caused by a combination of oscillator start-up time on the transmitter and ring-down time in the receiver's ceramic filter. It is important to consider this effect when planning protocol. To learn more about protocol considerations for the LC series we suggest you read Linx applications note #00232.

RECEIVING DATA

Once a reliable RF link has been established, the challenge becomes how to effectively transfer data across it. While a properly designed RF link provides reliable data transfer under most conditions, there are still distinct differences from a wired link that must be addressed. Since the RXM-LC-S modules do not incorporate internal encoding/decoding, a user has tremendous flexibility in how data is handled.

It is always important to separate what type of transmissions are technically possible from those that are legally allowable in the country of intended operation. You may wish to review application notes #00125 and #00140 along with Part 15 Sec. 231 for further details on acceptable transmission content.

Another area of consideration is that of data structure or protocol. If unfamiliar with the considerations for sending serial data in a wireless environment, you will want to review Linx application note #00232 (Considerations for sending data with the LC series). These issues should be clearly understood prior to commencing a significant design effort.

If you want to transfer simple control or status signals such as button presses or switch closures, and your product does not have a microprocessor on board your product or you wish to avoid protocol development, consider using an encoder and decoder IC set. These chips are available from a wide range of manufacturers including: Microchip (Keeloq), Holtek (available directly from Linx), and Motorola. These chips take care of all encoding, error checking, and decoding functions and generally provide a number of data pins to which switches can be directly connected. In addition, address bits are usually provided for security and to allow the addressing of multiple receivers independently. These IC's are an excellent way to bring basic Remote Control/Status products quickly and inexpensively to market. Additionally, it is a simple task to interface with inexpensive microprocessors such as the Microchip PIC or one of many IR, remote control, DTMF, and modem IC's.

Basic Remote Control Receiver Circuit

Figure 16 shows an example of a basic remote control receiver utilizing a decoder chip from Holtek. When a key is pressed at the transmitter, a corresponding pin at the receiver goes high. A schematic for the transmitter/encoder circuit may be found in the LC transmitter guide. These circuits can be easily modified and clearly demonstrate the ease of using the Linx LC modules for remote control applications.

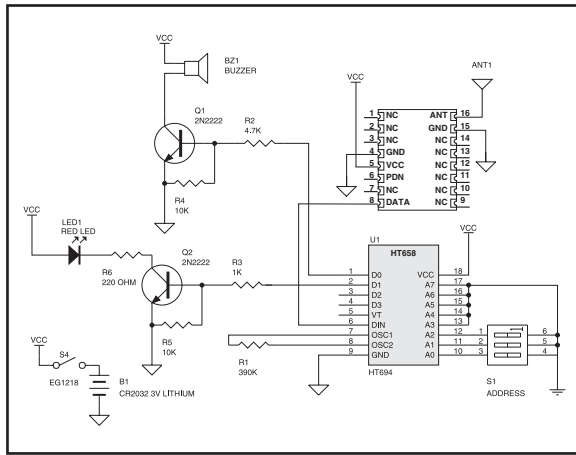

Figure 16: Basic Remote Control Receiver

BOARD LAYOUT CONSIDERATIONS

If you are at all familiar with RF devices you may be concerned about specialized board layout requirements. Fortunately, because of the care taken by Linx in designing the LC Series, integrating an LC-S receiver is very straightforward. This ease of application is a result of the advanced multi-layer isolated construction of the module. By adhering to good layout principles and observing a few basic design rules you can enjoy a straightforward path to RF success.

1. No conductive items should be placed within 0.15 in. of the module's top or sides.

2. A groundplane should be placed under the module as shown. In most cases, it will be placed on the bottom layer. The amount of overall plane area is also critical for the correct function of many antenna styles and is covered in the next section.

3. Keep receiver module away from interference sources. Any frequency of sufficient amplitude to enter the receiver's front end will reduce system range, cause bit errors, and may even prevent reception entirely. There are many possible sources of internally generated interference. High speed logic is one of the worst in this respect, as fast logic edges have harmonics which extend into the UHF band and the PCB tracks radiate these harmonics most efficiently. Microprocessors with external busses are generally incompatible with sensitive radio receivers. Single-chip microprocessors do not generally pose a problem. Switching power supplies, oscillators, even relays can also be significant sources of potential interference. Here again, the single best weapon against such problems is attention to placement and layout. Filter the supply with a high-frequency bypass capacitor as described above. Place adequate groundplane under all potential sources of noise.

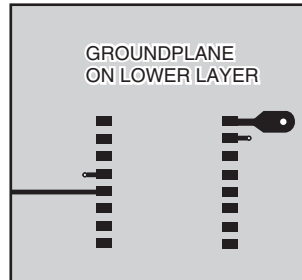

Always incorporate adequate groundplane

4. Observe appropriate layout practice between the module and its antenna. A simple trace may suffice for runs of less than 0.25" but longer distances should be covered using 50 coax or a 50 microstrip transmission line. This is because the trace leading to the module can effectively contribute to the length of the antenna, thus lowering its resonant bandwidth. In order to minimize loss and detuning, a microstrip transmission line is commonly utilized. The term microstrip refers to a PCB trace running over a groundplane, the width of which has been calculated to serve as a 50 transmission line between the module and antenna. This effectively removes the trace as a source of detuning. The correct trace width can be easily calculated using the information below.

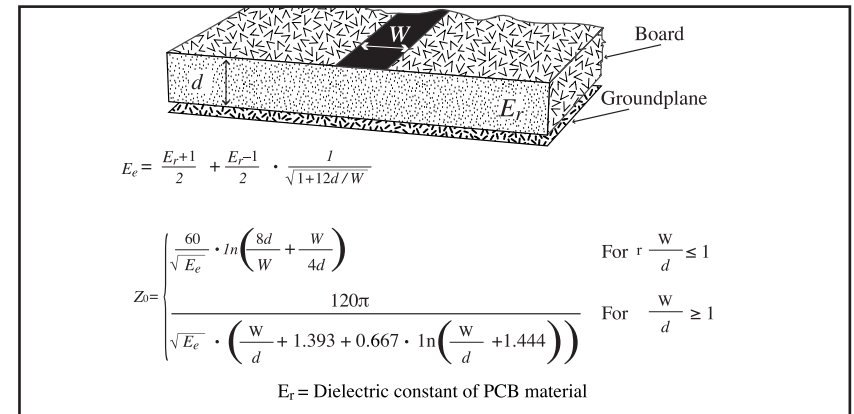

Figure 17: Microstrip Formulas (E_r = Dielectric constant of pc board material)

Dielectric Constant	Width/Height (W/d)	Effective Dielectric Constant	Characteristic Impedance
4.8	1.8	3.59	50.0
4	2	3.07	51.0
2.55	3	2.12	48.0

RECEIVER ANTENNA CONSIDERATIONS

The choice of antennas is one of the most critical and often overlooked design considerations. The range, performance, and legality of an RF link is critically dependent upon the type of antenna employed. Proper design and matching of an antenna is a complex task requiring sophisticated test equipment and a strong background in principles of RF propagation. While adequate antenna performance can often be obtained by trial and error methods, you may also want to consider utilizing a professionally designed antenna such as those offered by Linx. Our low-cost antenna line is designed to ensure maximum performance and compliance with Part 15 attachment requirements.

ANTENNA CONSIDERATIONS (CONT.)

A receiver antenna should give its optimum performance at the frequency or in the band for which the receiver was designed, and capture as little as possible of other off-frequency signals. The efficiency of the receiver's antenna is critical to maximizing range-performance. Unlike the transmitter antenna, where legal operation may mandate a reduction in antenna efficiency or attenuation, the receiver's antenna should be optimized as much as is practical.

It is usually best to utilize a basic quarter-wave whip for your initial concept evaluation. Once the prototype product is operating satisfactorily, a production antenna should be selected to meet the cost, size and cosmetic requirements of the product. To gain a better understanding of the considerations involved in the design and selection of antennas, please review application note #00500 "Antennas: Design, Application, Performance".

The following notes should help in optimizing antenna performance:

1. Proximity to objects such as a user's hand or body, or metal objects will cause an antenna to detune. For this reason the antenna shaft and tip should be positioned as far away from such objects as possible.
2. Optimum performance will be obtained from a 1/4- or 1/2-wave straight whip mounted at a right angle to the groundplane. In many cases this isn't desirable for practical or ergonomic reasons; thus, an alternative antenna style such as a helical, loop, patch, or base-loaded whip may be utilized.
3. If an internal antenna is to be used, keep it away from other metal components, particularly large items like transformers, batteries, and PCB tracks and groundplanes. In many cases, the space around the antenna is as important as the antenna itself.
4. In many antenna designs, particularly 1/4-wave whips, the groundplane acts as a counterpoise, forming, in essence, a 1/2-wave dipole. For this reason adequate groundplane area is essential. The groundplane can be a metal case or ground-fill areas on a circuit board. Ideally, it should have a surface area the overall length of the 1/4-wave radiating element. This is often not practical due to size and configuration constraints. In these instances a designer must make the best use of the area available to create as much groundplane in proximity to the base of the antenna as possible. When the antenna is remotely located or the antenna is not in close proximity to a circuit board plane or grounded metal case, a small metal plate may be fabricated to maximize antenna performance.
5. Remove the antenna as far as possible from potential interference sources. Any frequency of sufficient amplitude to enter the receiver's front end will reduce system range and can even prevent reception entirely. Switching power supplies, oscillators, even relays can also be significant sources of potential interference. The single best weapon against such problems is attention to placement and layout. Filter the module's power supply with a high-frequency bypass capacitor. Place adequate groundplane under potential sources of noise. Shield noisy board areas whenever practical.
6. In some applications it is advantageous to place the receiver and its antenna away from the main equipment. This avoids interference problems and allows the antenna to be oriented for optimum RF performance. Always use 50 coax, such as RG-174, for the remote feed.

COMMON ANTENNA STYLES

There are literally hundreds of antenna styles that can be successfully employed with the KH Series. Following is a brief discussion of the three styles most commonly utilized in compact RF designs. Additional antenna information can be found in Linx application notes #00100, #00126, #00140 and #00500. Linx also offers a broad line of antennas and connectors that offer outstanding performance and cost-effectiveness.

Whip Style

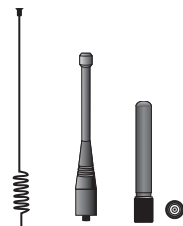

1/4-wave wire lengths for KH frequencies:

315Mhz = 8.9"
418Mhz = 6.7"
433Mhz = 6.5"

A whip-style monopole antenna provides outstanding overall performance and stability. A low-cost whip can be easily fabricated from wire or rod, but most product designers opt for the improved performance and cosmetic appeal of a professionally made model. To meet this need, Linx offers a wide variety of straight and reduced-height whip-style antennas in permanent and connectorized mounting styles.

The wavelength of the operational frequency determines an antenna's overall length. Since a full wavelength is often quite long, a partial 1/4-wave antenna is normally employed. Its size and natural radiation resistance make it well matched to Linx modules. The proper length for a 1/4-wave antenna can be easily found using the formula below. It is also possible to reduce the overall height of the antenna by using a helical winding. This decreases the antenna's bandwidth but is an excellent way to minimize the antenna's physical size for compact applications.

$$L = \frac{234}{F_{\text{MHz}}}$$

Where:
 L = length in feet of quarter-wave length
 F = operating frequency in megahertz

Helical Style



A helical antenna is precisely formed from wire or rod. A helical antenna is a good choice for low-cost products requiring average range-performance and internal concealment. A helical can detune badly in proximity to other objects and its bandwidth is quite narrow so care must be exercised in layout and placement.

Loop Style



A loop- or trace-style antenna is normally printed directly on a product's PCB. This makes it the most cost-effective of antenna styles. There are a variety of shapes and layout styles that can be utilized. The element can be made self-resonant or externally resonated with discrete components. Despite its cost advantages, PCB antenna styles are generally inefficient and useful only for short-range applications. Loop-style antennas are also very sensitive to changes in layout or substrate dielectric, which can introduce consistency issues into the production process. In addition, printed styles initially are difficult to engineer, requiring the use of expensive equipment, including a network analyzer. An improperly designed loop will have a high SWR at the desired frequency that can introduce substantial instability in the RF stages.

Linx offers a low-cost planar antenna called the "SPLATCH," which is an excellent alternative to the sometimes problematic PCB trace style. This tiny antenna mounts directly to a product's PCB and requires no testing or tuning. Its design is stable even in compact applications and it provides excellent performance in light of its compact size.

LEGAL CONSIDERATIONS

NOTE: KH Series Modules are designed as component devices which require external components to function. The modules are intended to allow for full Part 15 compliance; however, they are not approved by the FCC or any other agency worldwide. The purchaser understands that approvals may be required prior to the sale or operation of the device, and agrees to utilize the component in keeping with all laws governing its operation in the country of operation.

When working with RF, a clear distinction must be made between what is technically possible and what is legally acceptable in the country where operation is intended. Many manufacturers have avoided incorporating RF into their products as a result of uncertainty and even fear of the approval and certification process. Here at Linx our desire is not only to expedite the design process, but also to assist you in achieving a clear idea of what is involved in obtaining the necessary approvals to market your completed product legally.

In the United States the approval process is actually quite straightforward. The regulations governing RF devices and the enforcement of them are the responsibility of the Federal Communications Commission. The regulations are contained in the Code of Federal Regulations (CFR), Title 47. Title 47 is made up of numerous volumes; however, all regulations applicable to this module are contained in volume 0-19. It is strongly recommended that a copy be obtained from the Government Printing Office in Washington, or from your local government book store. Excerpts of applicable sections are included with Linx evaluation kits or may be obtained from the Linx Technologies web site (www.linxtechnologies.com). In brief, these rules require that any device which intentionally radiates RF energy be approved, that is, tested, for compliance and issued a unique identification number. This is a relatively painless process. Linx offers full EMC pre-compliance testing in our HP/Emco-equipped test center. Final compliance testing is then performed by one of the many independent testing laboratories across the country. Many labs can also provide other certifications the product may require at the same time, such as UL, CLASS A/B, etc. Once your completed product has passed, you will be issued an ID number which is then clearly placed on each product manufactured.

Questions regarding interpretations of the Part 2 and Part 15 rules or measurement procedures used to test intentional radiators, such as the KH modules, for compliance with the Part 15 technical standards, should be addressed to:

Federal Communications Commission
Equipment Authorization Division
Customer Service Branch, MS 1300F2
7435 Oakland Mills Road
Columbia, MD 21046

Tel: (301) 725-1585 / Fax: (301) 344-2050 E-Mail: labinfo@fcc.gov

International approvals are slightly more complex, although many modules are designed to allow all international standards to be met. If you are considering the export of your product abroad, you should contact Linx Technologies to determine the specific suitability of the module to your application.

All Linx modules are designed with the approval process in mind and thus much of the frustration that is typically experienced with a discrete design is eliminated. Approval is still dependent on many factors such as the choice of antennas, correct use of the frequency selected, and physical packaging. While some extra cost and design effort are required to address these issues, the additional usefulness and profitability added to a product by RF makes the effort more than worthwhile.

SURVIVING AN RF IMPLEMENTATION

Adding an RF stage brings an exciting new dimension to any product. It also means that additional effort and commitment will be needed to bring the product successfully to market. By utilizing premade RF modules, such as the KH series, the design and approval process will be greatly simplified. It is still important, however, to have an objective view of the steps necessary to ensure a successful RF integration. Since the capabilities of each customer vary widely it is difficult to recommend one particular design path, but most projects follow steps similar to those shown at the right.

In reviewing this sample design path you may notice that Linx offers a variety of services, such as antenna design, and FCC prequalification, that are unusual for a high-volume component manufacturer. These services, along with an exceptional level of technical support, are offered because we recognize that RF is a complex science requiring the highest caliber of products and support. "Wireless Made Simple" is more than just a motto, it's our commitment. By choosing Linx as your RF partner and taking advantage of the resources we offer, you will not only survive implementing RF, you may even find the process enjoyable.

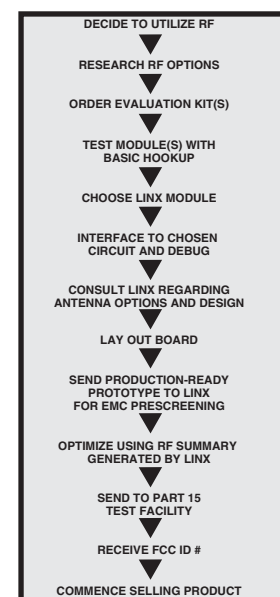

TYPICAL STEPS FOR IMPLEMENTING RF

HELPFUL APPLICATION NOTES FROM LINX

It is not the intention of this manual to address in depth many of the issues that should be considered to ensure that the modules function correctly and deliver the maximum possible performance. As you proceed with your design you may wish to obtain one or more of the following application notes, which address in depth key areas of RF design and application of Linx products.

NOTE #	LINX APPLICATION NOTE TITLE
00100	RF 101: Information for the RF challenged
00125	Considerations for operation in the 260 Mhz to 470 Mhz band
00130	Modulation techniques for low-cost RF data links
00140	The FCC Road: Part 15 from concept to approval
00150	Use and design of T-Attenuation Pads
00500	Antennas: Design, Application, Performance



U.S. CORPORATE HEADQUARTERS

LINX TECHNOLOGIES, INC.

**159 ORT LANE
MERLIN, OR 97532**

PHONE: (541) 471-6256

FAX: (541) 471-6251

www.linxtechnologies.com

Disclaimer

LinX Technologies is continually striving to improve the quality and function of its products. For this reason, we reserve the right to make changes without notice. The information contained in this Data Guide is believed to be accurate as of the time of publication. Specifications are based on representative lot samples. Values may vary from lot to lot and are not guaranteed. LinX Technologies makes no guarantee, warranty, or representation regarding the suitability or legality of any product for use in a specific application. None of these devices is intended for use in applications of a critical nature where the safety of life or property is at risk. The user assumes full liability for the use of product in such applications. Under no conditions will LinX Technologies be responsible for losses arising from the use or failure of the device in any application, other than the repair, replacement, or refund limited to the original product purchase price.
