

50 W silicon Zener diodes :

- Hermetically sealed metal according to normalization CCTU : F 10 and JEDEC DO-5.
- Available with anode to case or cathode to case connections.
- High surge capability : 300 W @ 10 ms.

Diodes Zener de 50 W au silicium :

- Encapsulées métal selon normalisation CCTU : F 10 et JEDEC DO-5.
- Disponible avec anode ou cathode reliée au boîtier.
- Forte tenue en surcharge : 300 W @ 10 ms.

$$P_{tot} = 20 \text{ W}$$

$$6,8 \text{ V} \leq V_{ZT \text{ nom}} \leq 180 \text{ V}$$

Case : DO-5 (CB-34)
Boîtier :

Cathode connected to case
RZ 6A → RZ 18B
Anode connected to case
RZ 6AR → RZ 18BR



ABSOLUTE RATINGS (LIMITING VALUES)

VALEURS LIMITEES ABSOLUES D'UTILISATION

$T_{amb} = 75^{\circ}\text{C}$

DC power dissipation (see fig. 1) <i>Dissipation de puissance en régime permanent (voir fig. 1)</i>	P_{tot}	20	W
Continuous reverse current <i>Courant inverse continu</i>	I_{ZM}	See page 2 <i>Voir page 2</i>	mA
Non repetitive surge peak power dissipation ($t = 10 \text{ ms}$) (see fig. 7) <i>Puissance de surcharge crête accidentelle ($t = 10 \text{ ms}$) (voir fig. 7)</i>	PRSM	300	W
Operating temperature <i>Température de fonctionnement</i>	T_{oper}	- 65 → + 150	$^{\circ}\text{C}$
Storage temperature <i>Température de stockage</i>	T_{stg}	- 65 → + 150	$^{\circ}\text{C}$
Maximum junction temperature <i>Température maximale de jonction</i>	T_j	150	$^{\circ}\text{C}$

Junction-case thermal resistance

Résistance thermique jonction-boîtier

max

$R_{th(j-c)}$

3,75

$^{\circ}\text{C/W}$

December 1983 - 1/3

ELECTRICAL CHARACTERISTIC
CARACTERISTIQUES ELECTRIQUES $T_{amb} = 25^{\circ}\text{C}$

Types	V_{ZT} / I_{ZT}			r_{ZT}/I_{ZT} max (Ω)	I_{ZT} (mA)	r_{ZK}/I_{ZK} max (Ω)	I_{ZK} (mA)	α VZ typ ($10^{-4}/^{\circ}\text{C}$)	I_{ZM} (mA)
	min	nom (V)	max						
RZ 6A, (R)	6,1	6,8	7,5	1	730	250	3	3	2700
RZ 8A, (R)	7,4	8,2	9,1	1,2	610	150	3	4	2200
RZ 10A, (R)	9,0	10	11	1,8	500	150	2	5	1800
RZ 12A, (R)	10,5	12	13,5	2,4	420	150	2	5,7	1540
RZ 15A, (R)	13	15	16,5	3,9	330	150	2	6,3	1250
RZ 18A, (R)	16	18	20,5	5,7	280	150	2	6,8	1000
RZ 22A, (R)	20	22	24,5	6,9	230	150	2	7,3	830
RZ 27A, (R)	24	27	30	9	180	200	2	7,7	665
RZ 33A, (R)	29	33	36	11	150	200	2	8	555
RZ 39A, (R)	35	39	43	13	120	200	2	8,3	465
RZ 47A, (R)	42	47	52	16	100	200	2	8,6	390
RZ 56A, (R)	50	56	62	18	90	500	2	8,8	320
RZ 68A, (R)	61	68	75	24	73	500	2	9	265
RZ 82A, (R)	74	82	91	33	60	500	2	9,2	220
RZ 10B, (R)	90	100	110	56	50	700	2	9,3	180
RZ 12B, (R)	105	120	135	76	42	700	2	9,4	154
RZ 15B, (R)	130	150	165	150	33	1000	2	9,6	125
RZ 18B, (R)	160	180	205	280	28	1000	2	9,6	100

CASE DESCRIPTION
DESCRIPTION DU BOITIER

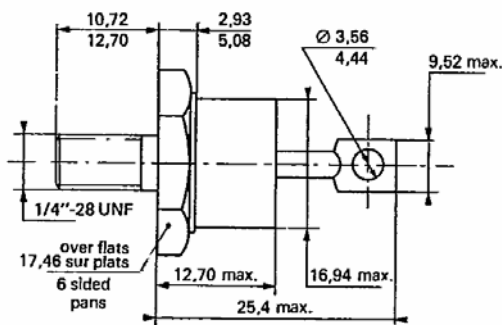

DO-5 (CB-34)

Weight : 25 g
 Masse : 25 g

Marking : clear
 Marquage en clair

Maximum torque value : 310 cm AN
 Couple de serrage maximum

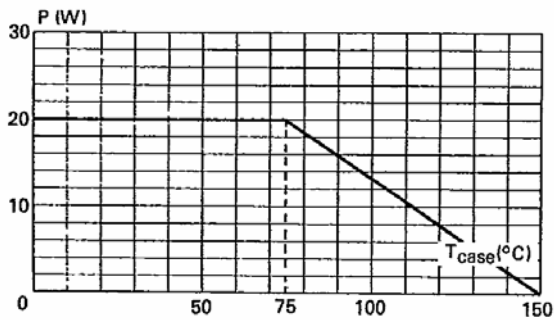

Fig. 1 - Maximum mean allowable power dissipation versus case temperature.

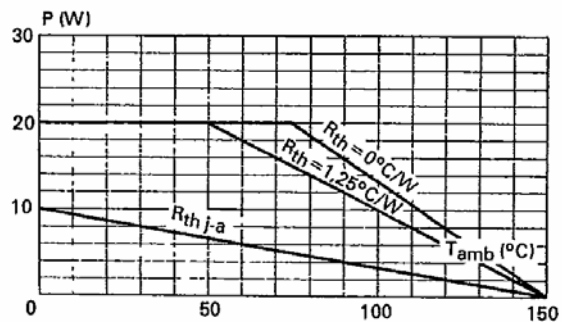

Fig. 2 - Maximum mean allowable power dissipation versus ambient temperature for different thermal resistances.

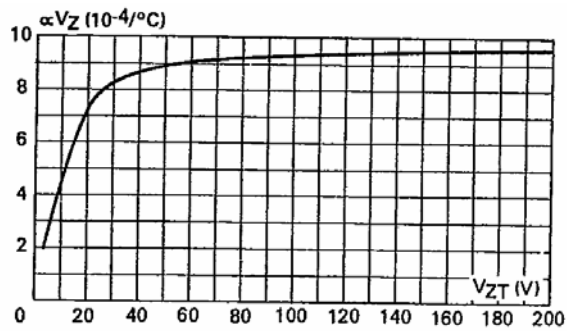

Fig. 3 - Temperature coefficient $\alpha V_Z = \frac{\Delta V_{ZT}}{V_{ZT} \Delta T}$ versus V_{ZT} (typical values).

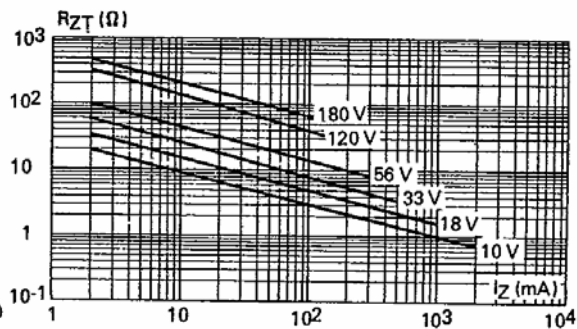

Fig. 4 - Differential resistance R_{ZT} versus I_Z (maximum values).

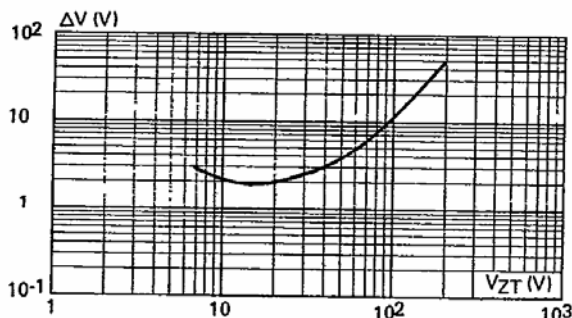

Fig. 5 - Regulation voltage variation for I_Z variation between 10% and 50% of I_{ZM} (typical values) D.C. measure ($T_{\text{case}} = 25^{\circ}\text{C}$).

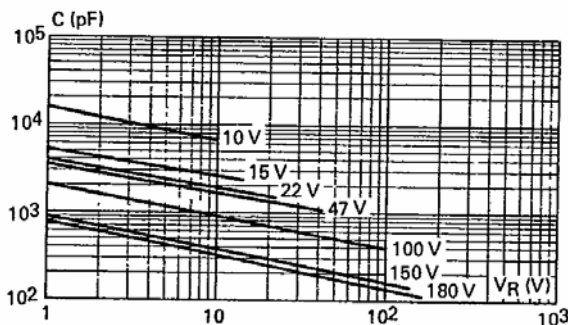

Fig. 6 - Capacity C versus reverse voltage V_R (typical values).

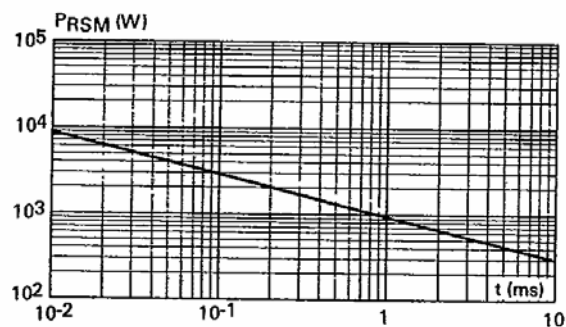

Fig. 7 - Non repetitive surge peak reverse power dissipation P_{RSM} versus pulse duration (rectangular impulsion).

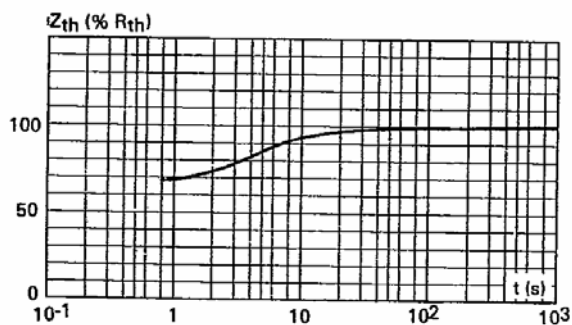

Fig. 8 - Transient thermal impedance Z_{th} versus pulse duration (rectangular impulsion).

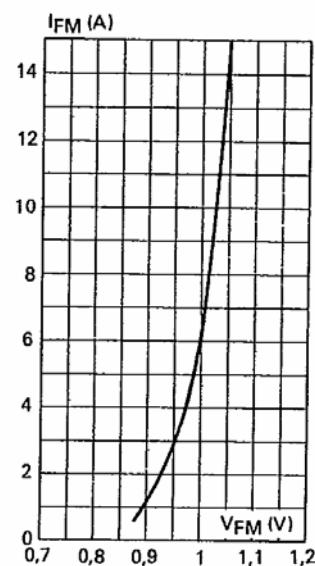

Fig. 9 - Peak forward current I_{FM} versus peak forward voltage drop V_{FM} at $T_{\text{case}} = 25^{\circ}\text{C}$ (typical values).