

TRANSFORMERS

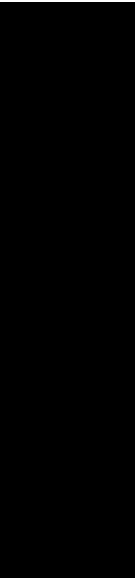

T1/CEPT/ISDN-PRI TRANSFORMERS DUAL SURFACE MOUNT

TM0001

Bel introduces a new ISDN T1/CEPT/ISDN-PRI Transformer in a surface mount package

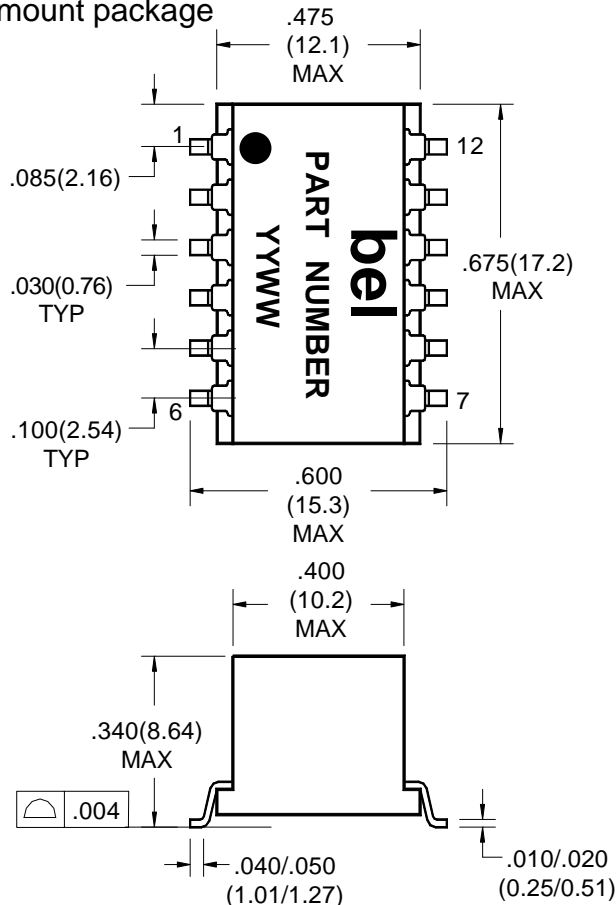

Dual surface mount package contains both transmit and receive transformers.
Models matched to leading transceiver chips.
Provide 1500 Vrms Isolation.

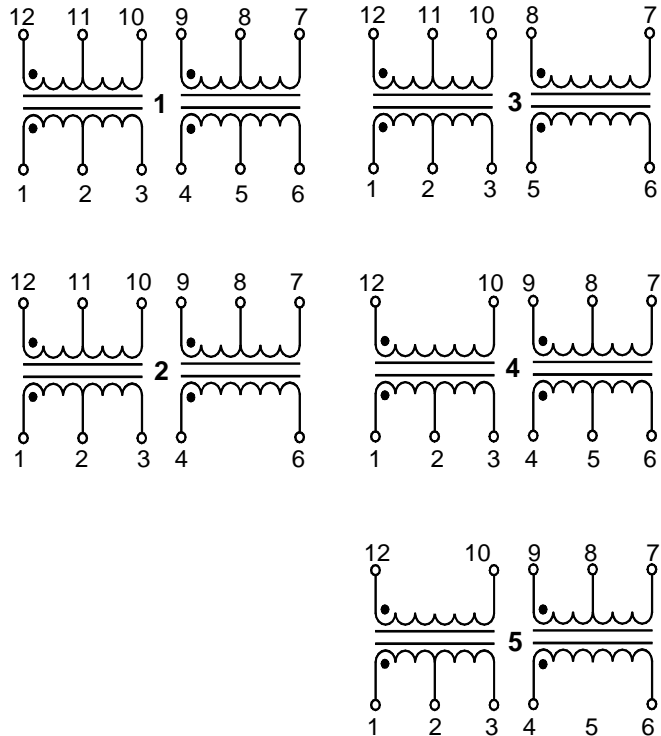

ELECTRICALS SPECIFICATIONS @ 25° C

Standard Temp. Range Models

Part Number	Turns Ratio (pri:sec +/-5%)	OCL 25° C (mH min)	Cw/w (pf max)	L _L (uH max)	DRC PRI (ohms max)	DRC SEC (ohms max)	Sch	Primary Pins
S553-6500-10	1ct:2ct & 1ct:2ct	1.2 & 1.2	31 & 31	0.60 & 0.6	0.7 & 0.7	1.2 & 1.2	1	12-10,4-6
S553-6500-11	1ct:2ct & 1:1.36ct	1.2 & 1.2	32 & 37	0.55 & 0.8	0.7 & 0.7	1.2 & 0.9	2	12-10,4-6
S553-6500-12	1:2ct & 1:1.14ct	1.2 & 1.2	40 & 35	0.55 & 0.8	0.7 & 0.7	1.2 & 0.9	5	12-10,4-6
S553-6500-13	1ct:2ct & 1:1	1.2 & 1.2	30 & 30	0.55 & 0.8	0.7 & 0.7	1.2 & 0.7	3	1-3,5-6
S553-6500-14	1:1.15ct & 1ct:2ct	1.5 & 1.2	35 & 35	0.60 & 0.6	0.7 & 0.7	0.9 & 1.2	4	12-10,4-6
S553-6500-15	1:1:1.26 & 1:2ct	1.5 & 1.2	40 & 40	0.40 & 0.5	0.7 & 0.7	0.9 & 1.2	5	12-10,4-6
S553-6500-16	1ct:2ct & 1:1.08ct	1.2 & 1.2	40 & 30	0.60 & 0.6	0.7 & 0.7	1.2 & 0.7	2	12-10,4-6

Corporate Office

Bel Fuse Inc.
198 Van Vorst Street, Jersey City, NJ 07302-4496
Tel: 201-432-0463
Fax: 201-432-9542
E-Mail: BelFuse@belfuse.com
Internet: <http://www.belfuse.com>

Far East Office

Bel Fuse Ltd.
8F/8 Luk Hop Street
San Po Kong
Kowloon, Hong Kong
Tel: 852-2328-5515
Fax: 852-2352-3706

European Office

Bel Fuse Europe Ltd.
Preston Technology Management Centre
Marsh Lane, Preston PR1 8UD
Lancashire, U.K.
Tel: 44-1772-556601
Fax: 44-1772-888366

T1/CEPT/ISDN-PRI TRANSFORMERS DUAL SURFACE MOUNT

TM0002

Bel introduces a new ISDN T1/CEPT/ISDN-PRI Transformer in a surface mount package

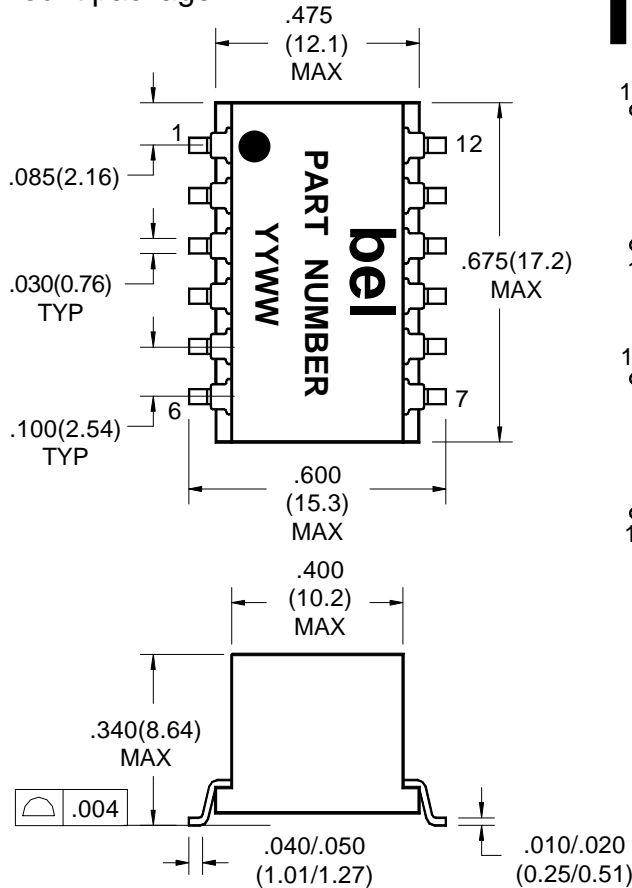

Dual surface mount package contains both transmit and receive transformers.
Models matched to leading transceiver chips.
Provide 1500 Vrms Isolation.

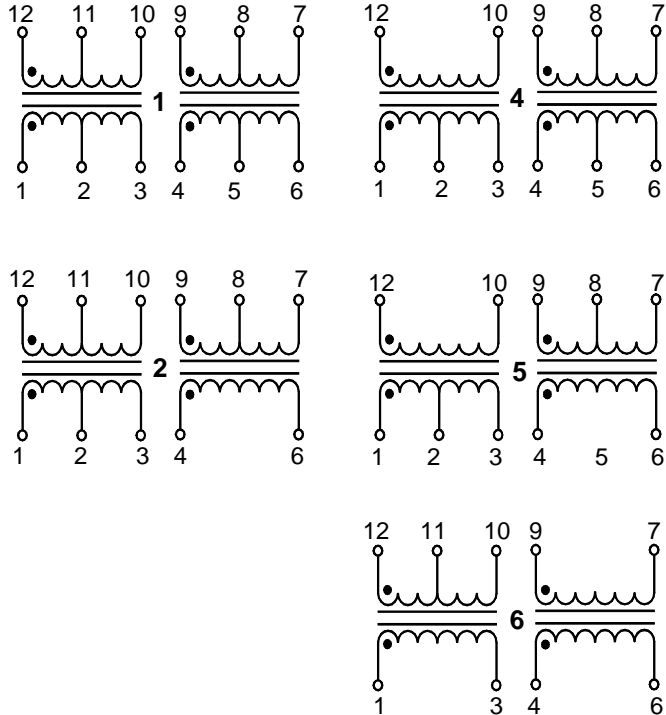

ELECTRICALS SPECIFICATIONS @ 25°C

* Extended Temp. Range Models

Part Number	Turns Ratio (pri:sec +/-5%)	OCL 25° C (mH min)	Cw/w (pf max)	L _L (uH max)	DRC PRI (ohms max)	DRC SEC (ohms max)	Sch	Primary Pins
S553-6500-03	1ct:1ct & 1ct:1ct	1.2 & 1.2	50 & 50	0.8 & 0.8	1.0 & 1.0	1.0 & 1.0	1	12-10,4-6
S553-6500-05	1ct:2ct & 1ct:2ct	1.2 & 1.2	50 & 50	0.8 & 0.8	1.0 & 1.0	1.7 & 1.7	1	12-10,4-6
S553-6500-06	1ct:2ct & 1:1.36ct	1.6 & 1.6	60 & 50	1.0 & 0.8	1.5 & 1.5	2.0 & 1.7	2	12-10,4-6
S553-6500-07	1:1.15ct & 1ct:2ct	1.5 & 1.2	60 & 50	0.8 & 0.8	1.0 & 1.0	1.0 & 1.7	4	12-10,4-6
S553-6500-08	1:1:1.266 & 1:2ct	1.5 & 1.2	50 & 60	0.8 & 0.8	1.0 & 1.0	1.1 & 1.7	5	12-10,4-6
S553-6500-09	2:2ct & 2:1	1.6 & 1.6	50 & 40	1.3 & 1.3	1.1 & 1.1	1.1 & 0.7	6	1-3,4-6

At -40 degree C, OCL is 600 uH min. for all low temp. models with the exception of S553-6500-09 which is 800 uH min.. All other parameters are specified at +25 degree C only.

*Extended temp. range is -40°C to +85°C

Corporate Office

Bel Fuse Inc.
198 Van Vorst Street, Jersey City, NJ 07302-4496
Tel: 201-432-0463
Fax: 201-432-9542
E-Mail: BelFuse@belfuse.com
Internet: http://www.belfuse.com

Far East Office

Bel Fuse Ltd.
8F/8 Luk Hop Street
San Po Kong
Kowloon, Hong Kong
Tel: 852-2328-5515
Fax: 852-2352-3706

European Office

Bel Fuse Europe Ltd.
Preston Technology Management Centre
Marsh Lane, Preston PR1 8UD
Lancashire, U.K.
Tel: 44-1772-556601
Fax: 44-1772-888366

T1/CEPT/ISDN-PR1 TRANSFORMER S559-6400-00

Bel offers a dual, T1, surface mount transformer packaged to provide both transmit and receive transformers. This design is easily customized for other leading transceiver chips by adjusting the turns ratio.

- * Dielectric Strength 1500 VAC.
- * Temperature Range is -40°C to 85°C.

SCHEMATIC

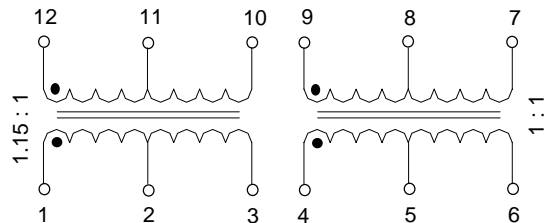

MECHANICALS

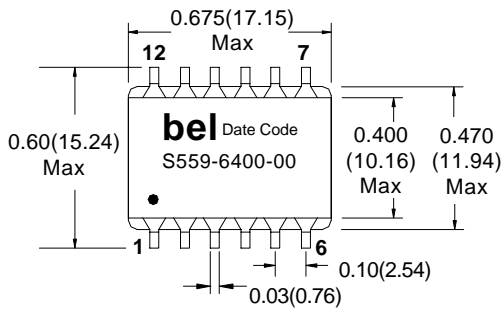

SUGGESTED PAD LAYOUT

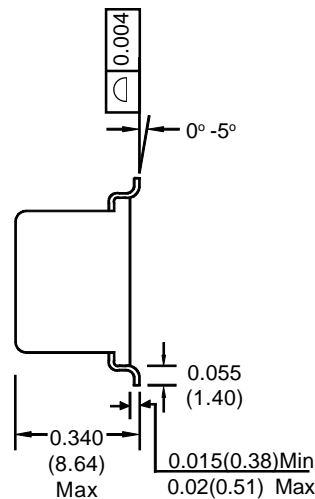
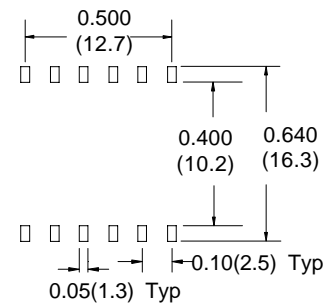

ELECTRICALS @ 25° C

Part Number	Turns Ratio +/- 5%	
	Pins (10-12):(1-3)	Pins (4-6):(7-9)
S559-6400-00	1CT:1.15CT	1CT:1CT

All dimensions are in inches(mm).
Dimension Tolerance is +/-0.01(0.25) unless otherwise specified.

Part Number	Primary Inductance OCL (mH) Min	Leakage Inductance L _L (μH) Max	Interwinding Capacitance (pF) Max	DCR (ohms) Max				Dielectric Strength (VAC)
	Pins (4-6) and Pins (10-12)	Pins (4-6) and Pins (10-12)	Pins (1,2,3) to Pins (10,11,12) and Pins (4,5,6) to Pins (7,8,9)	Pins (1-3)	Pins (4-6)	Pins (7-9)	Pins (10-12)	
S559-6400-00	1.5	0.8	60	1.1	1.0	1.0	1.0	1500

Dielectric Strength is measured Pins (1,2,3) to Pins (10,11,12) and Pins (4,5,6) to Pins (7,8,9).
Primary Inductance, Leakage Inductance, and Interwinding Capacitance are measured at 100KHz, 0.02VAC.

Corporate Office
Bel Fuse Inc.
198 Van Vorst Street, Jersey City, NJ 07302-4496
Tel: 201-432-0463
Fax: 201-432-9542
E-Mail: BelFuse@belfuse.com
Internet: http://www.belfuse.com

Far East Office
Bel Fuse Ltd.
8F/8 Luk Hop Street
San Po Kong
Kowloon, Hong Kong
Tel: 852-2328-5515
Fax: 852-2352-3706

European Office
Bel Fuse Europe Ltd.
Preston Technology Management Centre
Marsh Lane, Preston PR1 8UD
Lancashire, U.K.
Tel: 44-1772-556601
Fax: 44-1772-888366

T1/CEPT/ISDN-PR1 TRANSFORMER S553-6500-26

TM0004

Bel offers a dual, T1, surface mount transformer packaged to provide both transmit and receive transformers. This design is easily customized for other leading transceiver chips by adjusting the turns ratio.

- * Dielectric Strength 1500 VAC.
- * Extended Temperature Range is -40°C to 85°C.

MECHANICALS

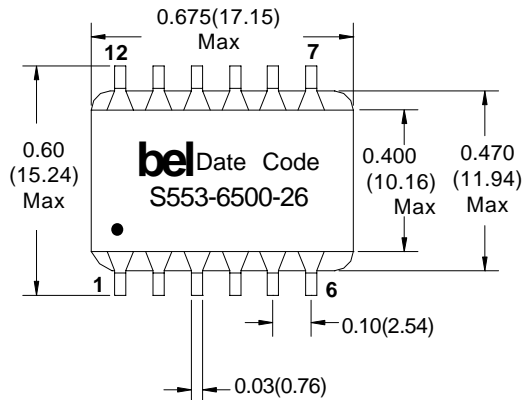

SCHEMATIC

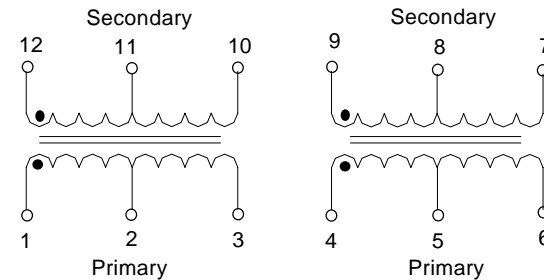

SUGGESTED PAD LAYOUT

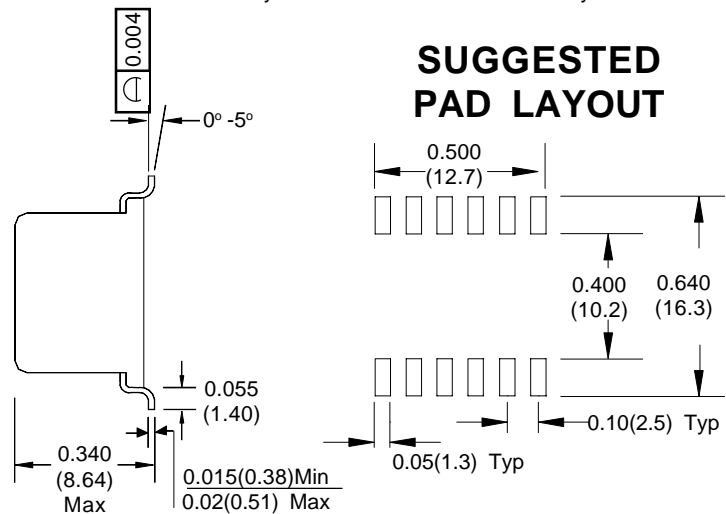

ELECTRICALS @ 25° C

Part Number	Turns Ratio +/- 2%	
	Pins (10-12):(1-3)	Pins (4-6):(7-9)
S553-6500-26	1CT:1.CT	1CT:2CT

All dimensions are in inches(mm).
Dimension Tolerance is +/-0.01(0.25)
unless otherwise specified.

Part Number	Primary Inductance OCL(mH) Min	Leakage Inductance L _r (μH) Max	Interwinding Capacitance (pF) Max	DCR (ohms) Max				Dielectric Strength (VAC)
	Pins (1-3) and Pins (4-6)	Pins (1-2) and Pins (4-6)	Pins (1,2,3) to Pins (10,11,12) and Pins (4,5,6) to Pins (7,8,9)	Pins (1-3)	Pins (4-6)	Pins (7-9)	Pins (10-12)	
S553-6500-26	1.2	0.8	50	1.0	1.0	1.8	1.0	1500

Dielectric Strength is measured Pins (1,2,3) to Pins (10,11,12) and Pins (4,5,6) to Pins (7,8,9).

Primary Inductance, Leakage Inductance, and Interwinding Capacitance are measured at 100KHz, 0.02VAC.

Corporate Office

Bel Fuse Inc.
198 Van Vorst Street, Jersey City, NJ 07302-4496
Tel: 201-432-0463
Fax: 201-432-9542
E-Mail: BelFuse@belfuse.com
Internet: http://www.belfuse.com

Far East Office

Bel Fuse Ltd.
8F/8 Luk Hop Street
San Po Kong
Kowloon, Hong Kong
Tel: 852-2328-5515
Fax: 852-2352-3706

European Office

Bel Fuse Europe Ltd.
Preston Technology Management Centre
Marsh Lane, Preston PR1 8UD
Lancashire, U.K.
Tel: 44-1772-556601
Fax: 44-1772-888366

T1/CEPT/ISDN-PRI TRANSFORMERS ENHANCED 3000VRMS ISOLATION

TM0005

MECHANICALS

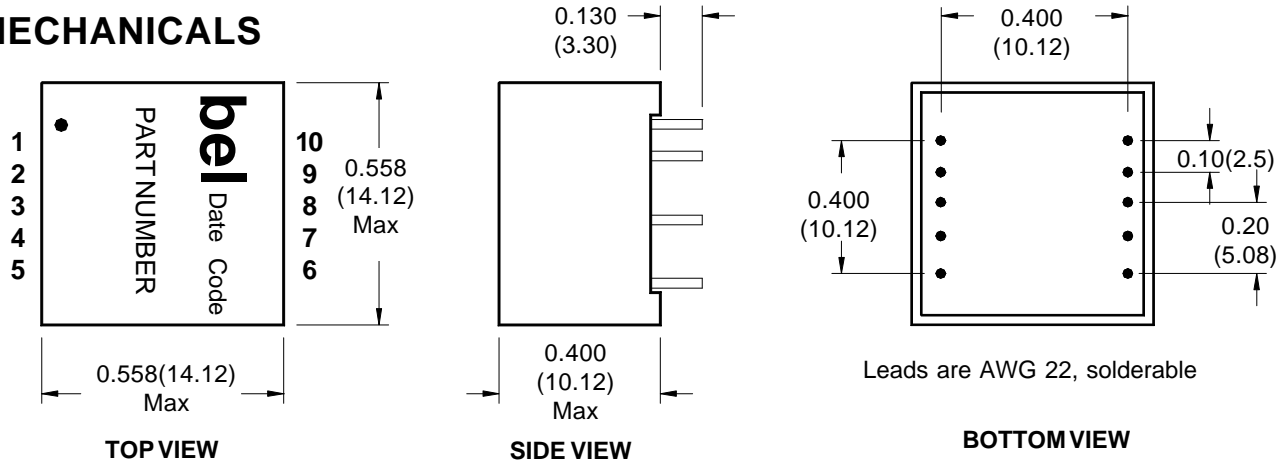

SCHEMATICS

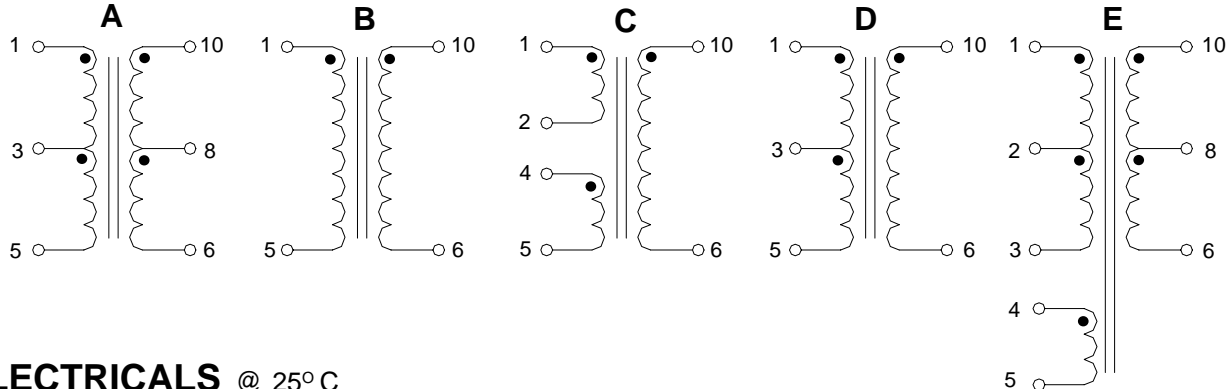

ELECTRICALS @ 25°C

Part Number	Turns Ratio +/- 2%	Primary Pins	OCL Primary (mH) Min	C _{ww} (pF) Max	L _L (μH) Max	DCR Pri (ohms) Max	DCR Sec (ohms) Max	Schem.
0553-6500-19	1:1	1-5	1.20	30	0.50	0.70	0.70	B
0553-6500-20	1CT:2CT	1-5	1.20	30	0.30-0.50	0.70	1.10	A
0553-6500-21	1:1.36CT	10-6	1.20	35	0.60	0.70	0.90	D
0553-6500-22	1:1:2	1-5(2,4 sh)	0.80	25	0.50	0.70	0.70	C
0553-6500-23	1:1:1.58	1-5 (2,4 sh)	0.80	18	0.70	0.70	0.50	C
Extended Temperature Units, -40°C to 85°C								
0553-6500-17	1:1:1.26	10-6	1.50	35	0.60	0.70	1.10	D
0553-6500-18	1CT:2CT	1-5	1.20	30	0.55	0.70	1.10	A
0553-6500-24	1CT:3CT:1	1-3	0.60	30	0.80	0.70	1.70	E

Corporate Office
 Bel Fuse Inc.
 198 Van Vorst Street, Jersey City, NJ 07302-4496
 Tel: 201-432-0463
 Fax: 201-432-9542
 E-Mail: BelFuse@belfuse.com
 Internet: http://www.belfuse.com

Far East Office
 Bel Fuse Ltd.
 8F/8 Luk Hop Street
 San Po Kong
 Kowloon, Hong Kong
 Tel: 852-2328-5515
 Fax: 852-2352-3706

European Office
 Bel Fuse Europe Ltd.
 Preston Technology Management Centre
 Marsh Lane, Preston PR1 8UD
 Lancashire, U.K.
 Tel: 44-1772-556601
 Fax: 44-1772-888366

T1 CARRIER INTERFACE TRANSFORMERS

T1/CEPT Telecom Line Interface Applications

TM0006

Bel provides transformer magnetics in several package and schematic variations for T1/CEPT Telecom Line Interface Applications. Bel's high quality semi-automated processes provide superior single small form, and standard dual transformers.

- * 2000 Vrms Isolation.
- * Primary Inductance is 1.20mH minimum.
- * Primary DCR is 0.80 ohms maximum.
- * Custom designs available upon request.

ELECTRICALS @ 25° C

Part Number	Turns Ratio (+/- 5%)	Leakage Inductance L_{L} (uH) Max	Coupling Capacitance C_{ww} (pF) Max	Sec DCR (ohms) Max	#Pins on Package and Style	Schem.
A553-0013-00	1:1.385CT/1:1:1	0.80/0.50	35	0.80	16 Topper	A
A553-0013-01	1CT:2CT/1:1	0.80/0.50	35	1.8/0.80	14 Topper	B
A553-0013-03	1:1.385CT/1:1CT	0.80/0.50	35	0.80/0.80	14 Topper	C
A553-0013-05	Pins (1-2):(14:12) 1:1 (1-3):(14:12) 1.25:1 (5-7):(10:8) 1:2CT	0.50/0.50/0.80	50	0.80/0.80/1.8	14 Topper	C
A553-0013-06	1:2CT/1:2CT	0.80/0.80	35	1.8/1.8	14 Topper	C
A553-0013-07	1:1.15CT/1:2CT	0.50/0.80	35	0.80/1.8	14 Topper	C
A553-0013-08	1:1:1.266/1:2CT	0.80/0.80	35	0.80/1.8	14 Topper	C
0553-0013-IC	1:1:1	0.50	35	0.80	6 "T" Topper	E
0553-0013-AC	1:1	0.50	35	0.80	6 "T" Topper	F
0553-0013-BC	1CT:1	0.50	35	0.80	6 "T" Topper	G
0553-0013-HC	1CT:2CT	0.80	35	1.8	6 "T" Topper	K
0553-0013-1J	1:2CT/1:2CT	0.80/0.80	35	1.8/1.8	14 DIL	C
0553-0013-2J	1:2CT/1:1.36	0.80/0.80	35	1.8/0.80	14 DIL	D
0553-0013-4J	1CT:2CT/1:1	0.80/0.50	35	1.8/0.8	14 DIL	B
0553-0013-RC	1:1.15CT	0.50	35	0.80	6 "T" Topper	G
0553-0013-SC	1:1:1.266	0.80	35	0.80	6 "T" Topper	E
0553-1167-00	1:1:1.266/1:2CT	0.50/0.60	35/40	0.80/1.8	14 DIL	C

Schematic and Mechanical information for the above components are located on the facing page.

T1 CARRIER INTERFACE TRANSFORMERS

SCHEMATICS

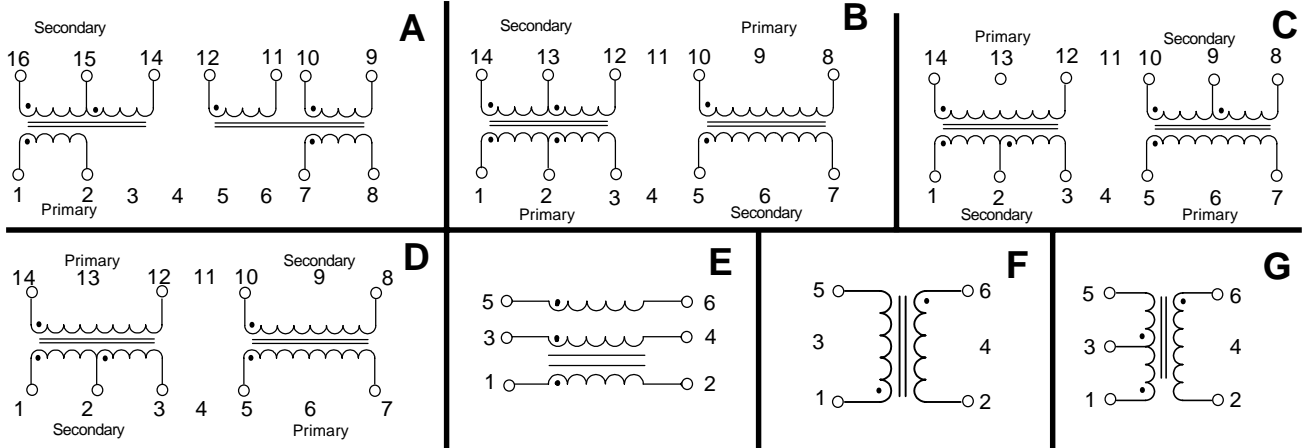

MECHANICALS

Package Style (14/16 Pins)

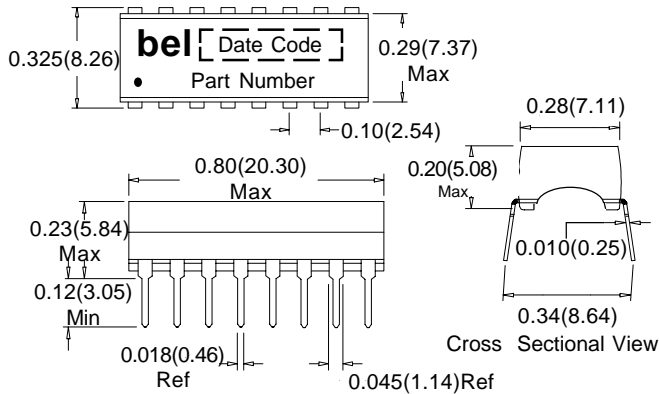

Note: For 14 Pin package, external package dimensions and pin distances are identical. There are only seven pins per side.

Package Style "T"

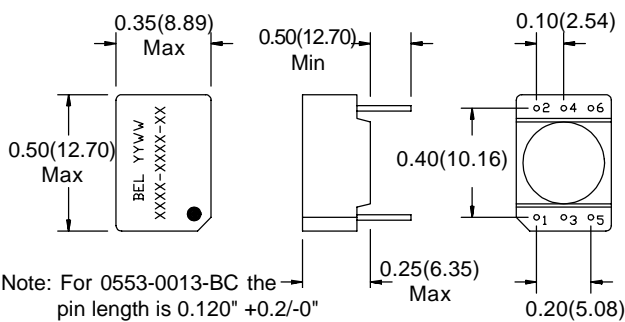

Note: For 0553-0013-BC the pin length is 0.120" +0.2/-0"

Package Style DIL

Note: 0553-1167-00 is missing pins 4 and 11, and is 0.80" long and 0.25" high from seating plane.

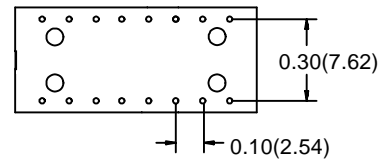
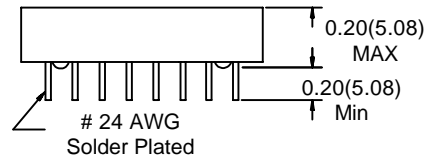
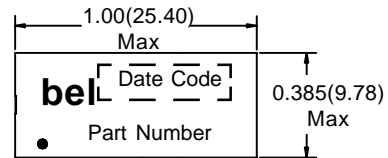
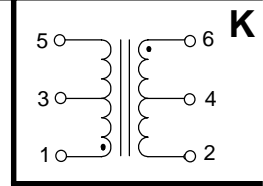

Dimensions are in inches(mm).
 Dimension Tolerance is +/- 0.02(0.51) unless otherwise specified.

Corporate Office

Bel Fuse Inc.
 198 Van Vorst Street, Jersey City, NJ 07302-4496
 Tel: 201-432-0463
 Fax: 201-432-9542
 E-Mail: BelFuse@belfuse.com
 Internet: http://www.belfuse.com

Far East Office

Bel Fuse Ltd.
 8F/8 Luk Hop Street
 San Po Kong
 Kowloon, Hong Kong
 Tel: 852-2328-5515
 Fax: 852-2352-3706

European Office

Bel Fuse Europe Ltd.
 Preston Technology Management Centre
 Marsh Lane, Preston PR1 8UD
 Lancashire, U.K.
 Tel: 44-1772-556601
 Fax: 44-1772-888366

SURFACE MOUNT T1 CARRIER INTERFACE TRANSFORMERS T1/CEPT Telecom Line Interface Applications

TM0007

Bel offers a new cost effective package on our standard T1/CEPT Telecom Interface Line Transformers. This sixteen lead, surface mount package, provides a superior, cost effective, quality product.

ELECTRICALS @ 25°C

Part Number	Turns Ratio T1/T2	Leakage Inductance L_L (μ H) Max	DCR (ohms) Max	Schematic
S553-0013-00	1:1.385CT/1:1:1	0.80/0.50	0.80	A
S553-0013-01	1CT:2CT/1:1	0.80/0.50	1.80/0.80	B
S553-0013-02	1:2CT/1:1.36	0.80/0.80	1.80/0.80	C
S553-0013-03	1:2CT/1:2CT	0.80/0.80	0.80/1.80	D
S553-0013-06	1:1.15CT/1:2CT	0.50/0.80	0.80/1.80	D
S553-0013-07	1:1:1.266/1:2CT	0.80/0.80	0.80/1.80	D

SCHEMATICS

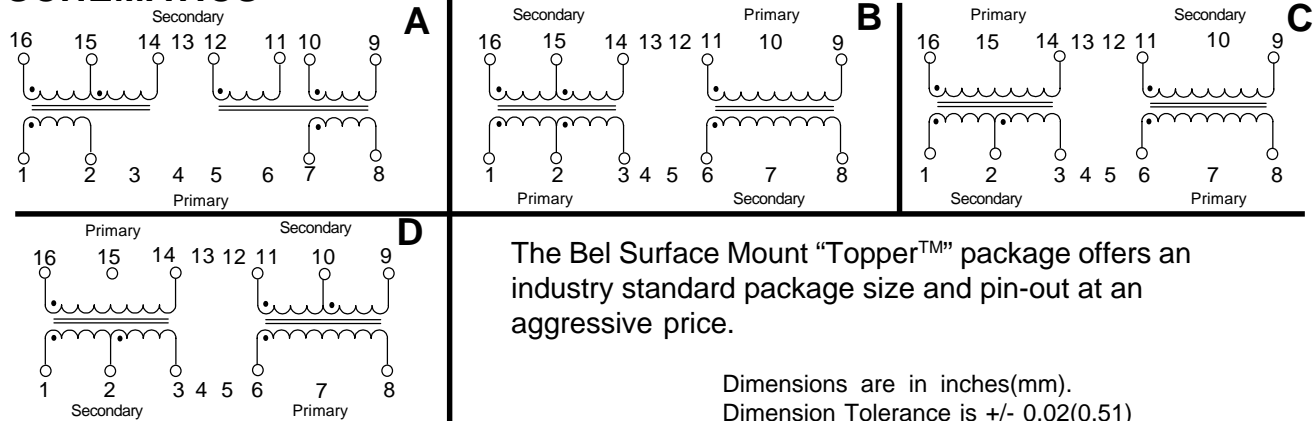

The Bel Surface Mount "Topper™" package offers an industry standard package size and pin-out at an aggressive price.

Dimensions are in inches(mm).
Dimension Tolerance is +/- 0.02(0.51)
unless otherwise specified.

MECHANICALS

Package Style SMT

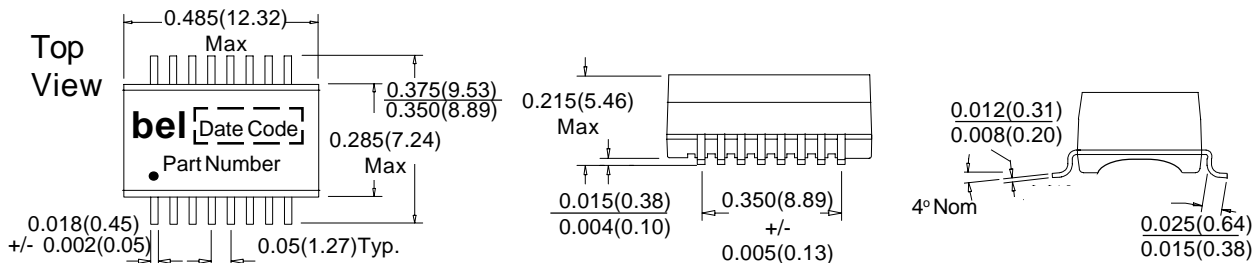

Corporate Office

Bel Fuse Inc.
198 Van Vorst Street, Jersey City, NJ 07302-4496
Tel: 201-432-0463
Fax: 201-432-9542
E-Mail: BelFuse@belfuse.com
Internet: <http://www.belfuse.com>

Far East Office

Bel Fuse Ltd.
8F/8 Luk Hop Street
San Po Kong
Kowloon, Hong Kong
Tel: 852-2328-5515
Fax: 852-2352-3706

European Office

Bel Fuse Europe Ltd.
Preston Technology Management Centre
Marsh Lane, Preston PR1 8UD
Lancashire, U.K.
Tel: 44-1772-556601
Fax: 44-1772-888366

**SURFACE MOUNT T1 CARRIER
INTERFACE TRANSFORMERS**
T1/CEPT Telecom Line Interface Applications

TM0008

Bel offers a new cost effective package on our standard T1/CEPT Telecom Interface Line Transformers. This sixteen lead, "Topper™", surface mount package, provides a superior, cost effective, quality product.

- * High Pot 2000 Vrms measured for one minute.
- * Primary Inductance (OCL) is 1.20 Milihenries minimum.
- * Primary DCR is 0.80 ohms maximum.

ELECTRICALS @ 25° C

Part Number	Turns Ratio T1/T2	Leakage Inductance L_L (μ H) Max	DCR (ohms) Max	Coupling Capacitance (pF) Max	Schematic
S553-0013-04	1:1.7/1:2CT	0.50/0.80	0.80/1.80	35	A
S553-0013-05	1:1/1:1.25/1:2CT	0.50/0.50/0.80	0.80/1.10/1.80	50	B

* Coupling Capacitance (C_{ww}) is 35 PicoFarads maximum.

* Custom designs available.

Turns ratio of S553-0013-05 ia (1-2):(16-14)/(1-3):(16-14)/(5-8):(9-11)

SCHEMATICS

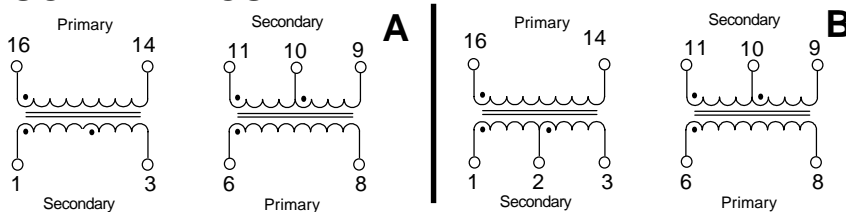

The Bel Surface Mount "Topper™" package offers an industry standard package size and pin-out at an aggressive price.

Dimensions are in inches(mm).
Dimension Tolerance is +/- 0.02(0.51) unless otherwise specified.

MECHANICALS

Package Style SMT

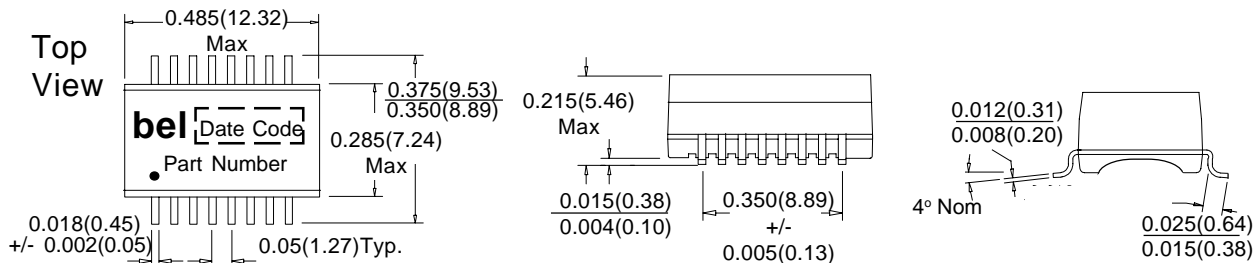

Corporate Office
Bel Fuse Inc.
198 Van Vorst Street, Jersey City, NJ 07302-4496
Tel: 201-432-0463
Fax: 201-432-9542
E-Mail: BelFuse@belfuse.com
Internet: http://www.belfuse.com

Far East Office
Bel Fuse Ltd.
8F/8 Luk Hop Street
San Po Kong
Kowloon, Hong Kong
Tel: 852-2328-5515
Fax: 852-2352-3706

European Office
Bel Fuse Europe Ltd.
Preston Technology Management Centre
Marsh Lane, Preston PR1 8UD
Lancashire, U.K.
Tel: 44-1772-556601
Fax: 44-1772-888366

T1/CEPT/ISDN-PRI TRANSFORMER S553-3855-02

TM0009

Bel introduces a new "pick and place" compatible, small footprint, surface mount impedance matching transformer for ISDN-PRI/T1/CEPT applications.

- * Pick and Place Compatible.
- * Small form factor to maximize board space.

MECHANICALS

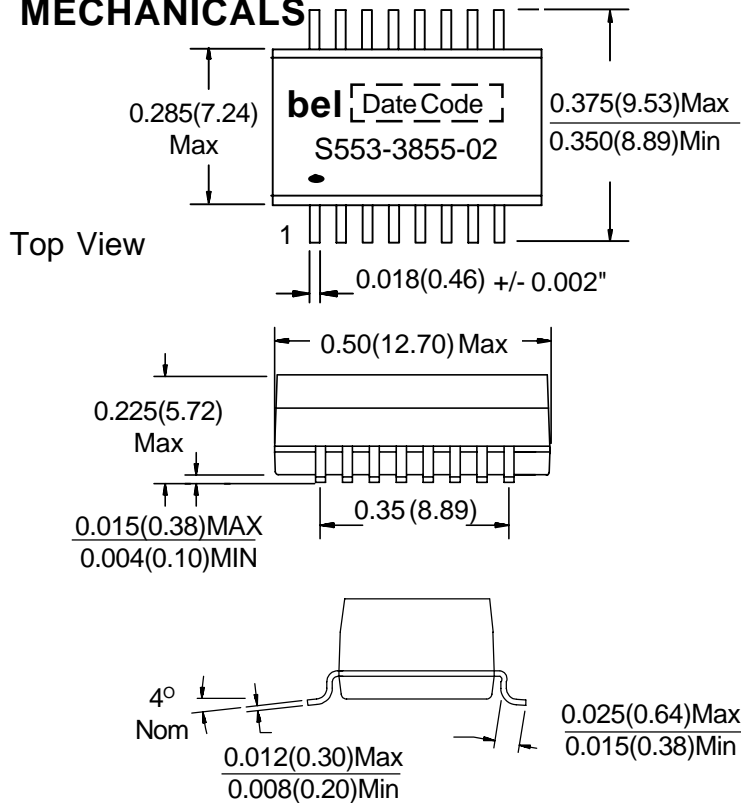

SCHEMATIC

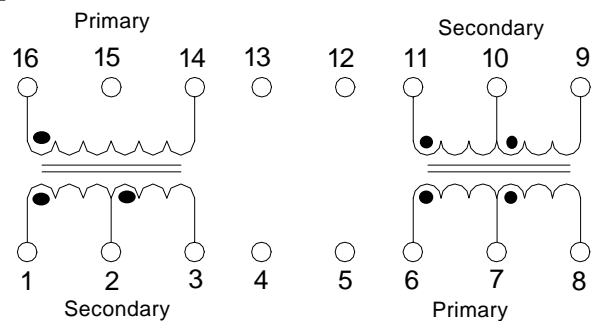

Dimensions in inches (mm)
Dimension tolerance +/- 0.01(0.25)
unless otherwise stated

ELECTRICALS @ 25° C

Part Number	Turns Ratio		Primary Inductance OCL (mH) Min	Leakage Inductance L _L (mH) Max		Interwinding Capacitance C _{ww} (pF) Max	DC Resistance DCR Pri (ohm) Max	DC Resistance DCR Sec (ohm) Max		Hipot (Vrms) Min
	Pins (16-14):(1-3)	Pins (6-8):(11-9)		Pins (16-14)*	Pins (6-8)**			Pins (1-3)	Pins (11-9)	
S553-3855-02	1:1.15CT	1CT:2CT	1.20	0.6	0.8	30	0.70	0.70	1.00	1500

* Leakage Inductance is measured with Pins (1-3) shorted.
** Leakage Inductance is measured with Pins (11-9) shorted.

Corporate Office
Bel Fuse Inc.
198 Van Vorst Street, Jersey City, NJ 07302-4496
Tel: 201-432-0463
Fax: 201-432-9542
E-Mail: BelFuse@belfuse.com
Internet: http://www.belfuse.com

Far East Office
Bel Fuse Ltd.
8F/8 Luk Hop Street
San Po Kong
Kowloon, Hong Kong
Tel: 852-2328-5515
Fax: 852-2352-3706

European Office
Bel Fuse Europe Ltd.
Preston Technology Management Centre
Marsh Lane, Preston PR1 8UD
Lancashire, U.K.
Tel: 44-1772-556601
Fax: 44-1772-888366

T1 SURFACE MOUNT TRANSFORMER
S553-0320-00

TM0010

Bel introduces a T1 transformer designed to support the industry's aggressive price requirements, while remaining fit and function compatible to the industry standards. Carefully controlled internal construction provides minimal insertion and return loss.

* Input to Output Isolation Voltage is 2000 Vrms, measured for 1 second.

**M
E
C
H
A
N
I
C
A
L
S**

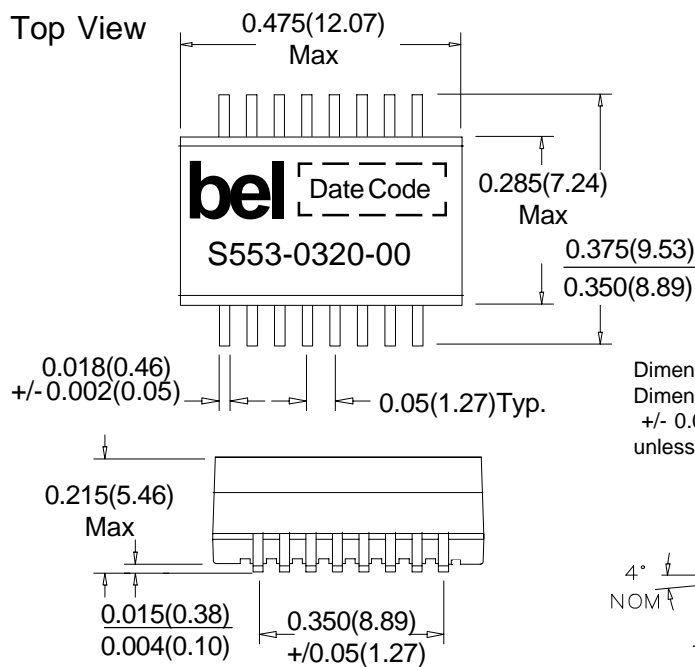

**S
C
H
E
M
A
T
I
C**

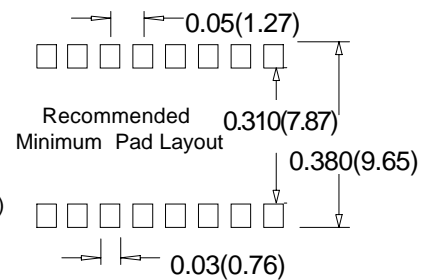
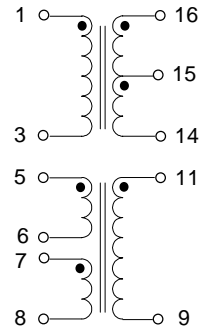

Dimensions in inches (mm)
Dimension tolerance
+/- 0.01(0.25)
unless otherwise stated

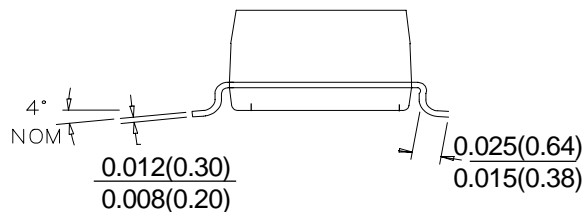

ELECTRICALS @ 25° C

Part Number	Turns Ratio (+/- 5%)	Primary Inductance OCL (mH) min	Leakage Inductance L _L (nH) Max	Leakage Inductance L _L (nH) Max	Coupling Capacitance C _{ww} (pF) Max
		1:2 2:2:1	Pins (1-3) to Pins (5-6)	Pins (1-3) tie Pins (16,15,14)	Pins (5-6) tie Pins (11,9)
S553-0320-00		1.2	500	1000	35

Electricals measured at 100KHz, 20mV.

Corporate Office
Bel Fuse Inc.
198 Van Vorst Street, Jersey City, NJ 07302-4496
Tel: 201-432-0463
Fax: 201-432-9542
E-Mail: BelFuse@belfuse.com
Internet: http://www.belfuse.com

Far East Office
Bel Fuse Ltd.
8F/8 Luk Hop Street
San Po Kong
Kowloon, Hong Kong
Tel: 852-2328-5515
Fax: 852-2352-3706

European Office
Bel Fuse Europe Ltd.
Preston Technology Management Centre
Marsh Lane, Preston PR1 8UD
Lancashire, U.K.
Tel: 44-1772-556601
Fax: 44-1772-888366

TRANSFORMER MODULE S553-5692-08

TM0011

Bel now provides a one component, surface mount transformer module. The compact packaging allows for a "single component" solution which provides cost reduction and placement ease.

* 1500 Vrms Isolation.

MECHANICALS



All dimensions are in inches(mm).
Dimension tolerance is +/- 0.01(0.25) unless otherwise specified.

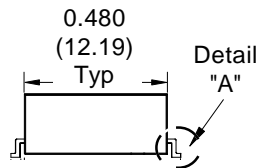
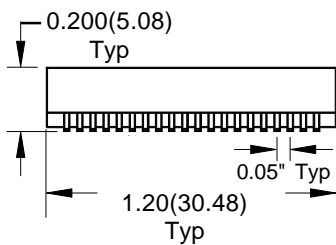

RECOMMENDED PCB PAD LAYOUT

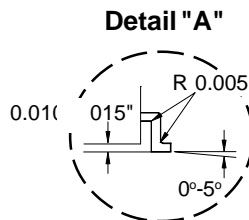
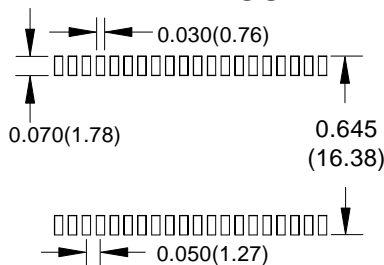

SCHEMATIC

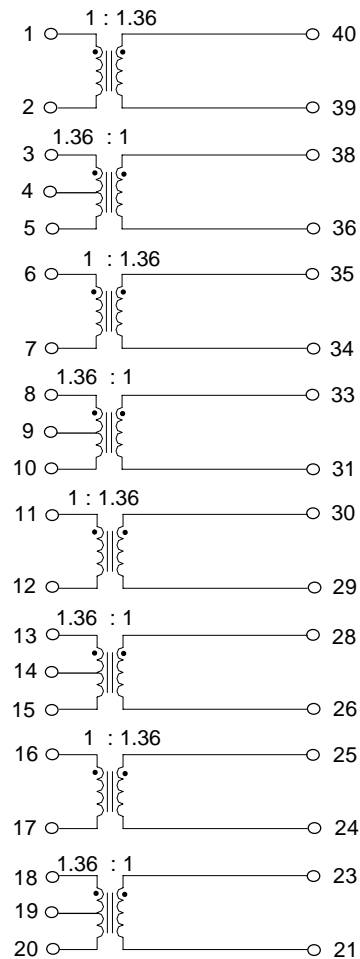

ELECTRICALS at 25°C

Part Number	Turns Ratio +/- 2%		Primary Inductance OCL (mH) Min	DC Resistance (Ω)		Leakage Inductance L _L (μH) Max	Interwinding Capacitance C _{ww} (pF)	Isolation Voltage (Vrms)
	Primary	Secondary		Primary	Secondary			
S553-5692-08	1: 1.36	1.36 :1	1.25	1.9	2.8	0.8	35	1500

Leakage Inductance measured at 100kHz.

Corporate Office
Bel Fuse Inc.
198 Van Vorst Street, Jersey City, NJ 07302-4496
Tel: 201-432-0463
Fax: 201-432-9542
E-Mail: BelFuse@belfuse.com
Internet: http://www.belfuse.com

Far East Office
Bel Fuse Ltd.
8F/8 Luk Hop Street
San Po Kong
Kowloon, Hong Kong
Tel: 852-2328-5515
Fax: 852-2352-3706

European Office
Bel Fuse Europe Ltd.
Preston Technology Management Centre
Marsh Lane, Preston PR1 8UD
Lancashire, U.K.
Tel: 44-1772-556601
Fax: 44-1772-888366

TRANSFORMER MODULE
S553-5692-09

TM0012

Bel now provides a one component, surface mount transformer module. The compact packaging allows for a "single component" solution which provides cost reduction and placement ease.

* 1500 Vrms Isolation.

MECHANICALS

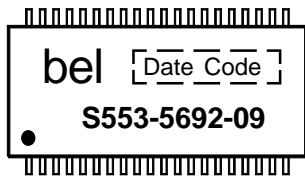

All dimensions are in inches(mm).
Dimension tolerance is +/- 0.01(0.25) unless otherwise specified.

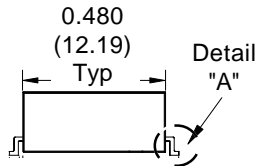
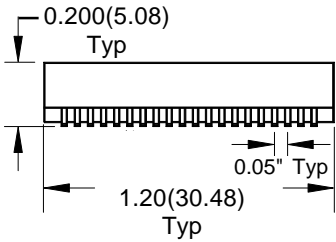

RECOMMENDED PCB PAD LAYOUT

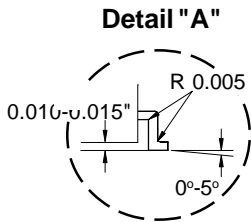
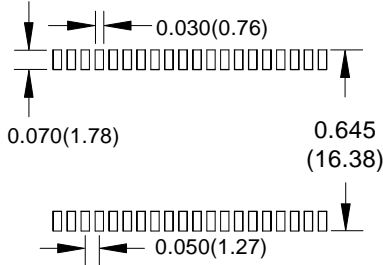

SCHEMATIC

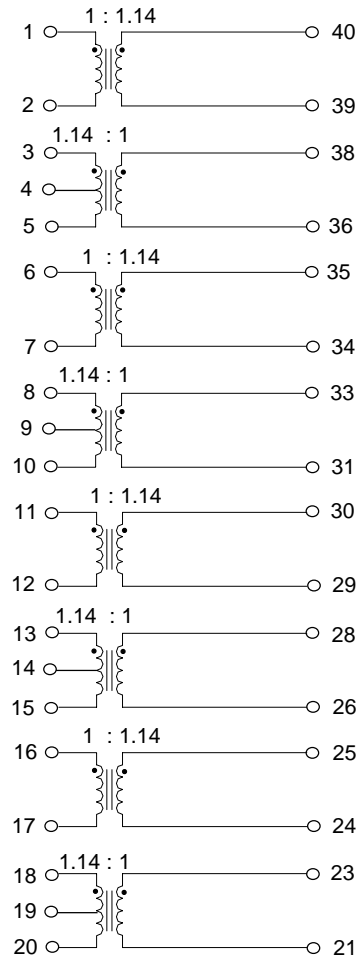

ELECTRICALS @ 25° C

Part Number	Turns Ratio +/- 2%		Primary Inductance OCL (mH) Min	DC Resistance (Ω)		Leakage Inductance L _L (μH) Max	Interwinding Capacitance C _{ww} (pF)	Isolation Voltage (Vrms)
	Primary	Secondary		Primary	Secondary			
S553-5692-09	1:1.14	1.14:1	1.25	2.2	2.6	0.8	35	1500

Leakage Inductance measured at 100kHz.

Corporate Office
Bel Fuse Inc.
198 Van Vorst Street, Jersey City, NJ 07302-4496
Tel: 201-432-0463
Fax: 201-432-9542
E-Mail: BelFuse@belfuse.com
Internet: http://www.belfuse.com

Far East Office
Bel Fuse Ltd.
8F/8 Luk Hop Street
San Po Kong
Kowloon, Hong Kong
Tel: 852-2328-5515
Fax: 852-2352-3706

European Office
Bel Fuse Europe Ltd.
Preston Technology Management Centre
Marsh Lane, Preston PR1 8UD
Lancashire, U.K.
Tel: 44-1772-556601
Fax: 44-1772-888366

T1 TRANSFORMER 0559-5999-04

TM0013

Bel introduces a new dual-in-line, T1 Transformer.

* Isolation Voltage is 1500 Vrms

MECHANICALS

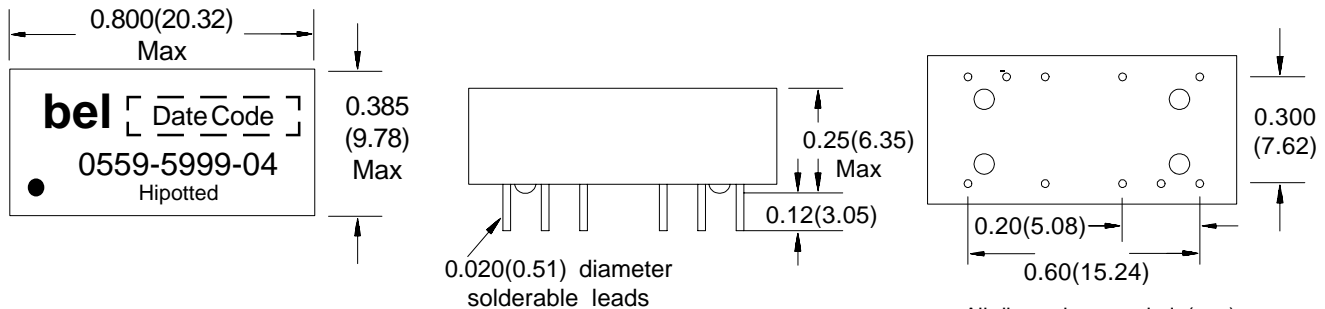

All dimensions are in in(mm).
Dimension tolerance is +/-0.02(0.51) unless otherwise specified.

SCHEMATIC

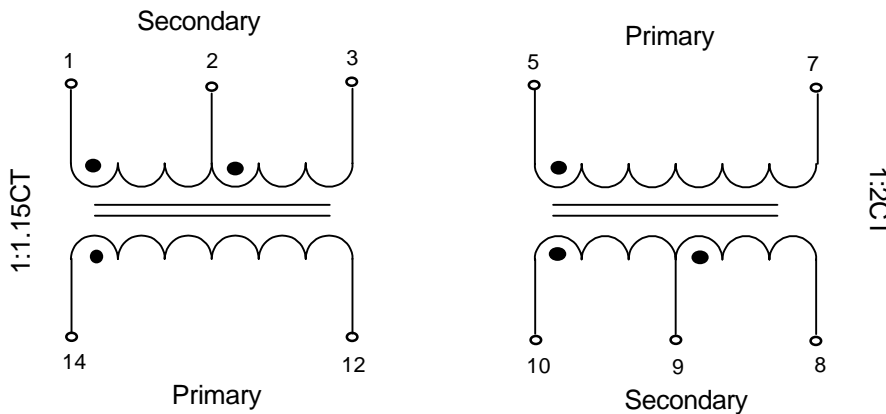

ELECTRICALS @ 25° C

Part Number	Primary Inductance OCL (mH) Min		Leakage Inductance L_L (μ H) Max		Coupling Capacitance C_{wv} (pF) Max		DCR Ω (ohms) Max	
	Pins (5-7)	Pins (14-12)	Pins (5-7)	Pins (14-12)	Pins (14-1)	Pins (5-10)	Pins (5-7) to (14-12)	Pins (1-3) to (8-10)
0559-5999-04	1.2	1.5	0.5	0.6	35	40	0.7	1.1

Primary Inductance and Leakage Inductance measured at 100KHz, 20mV.

Corporate Office

Bel Fuse Inc.
198 Van Vorst Street, Jersey City, NJ 07302-4496
Tel: 201-432-0463
Fax: 201-432-9542
E-Mail: BelFuse@belfuse.com
Internet: <http://www.belfuse.com>

Far East Office

Bel Fuse Ltd.
8F/8 Luk Hop Street
San Po Kong
Kowloon, Hong Kong
Tel: 852-2328-5515
Fax: 852-2352-3706

European Office

Bel Fuse Europe Ltd.
Preston Technology Management Centre
Marsh Lane, Preston PR1 8UD
Lancashire, U.K.
Tel: 44-1772-556601
Fax: 44-1772-888366

T1 TRANSFORMER
0559-5999-05

TM0014

Bel introduces a new dual-in-line, T1 Transformer.

* Isolation Voltage is 1500 Vrms

MECHANICALS

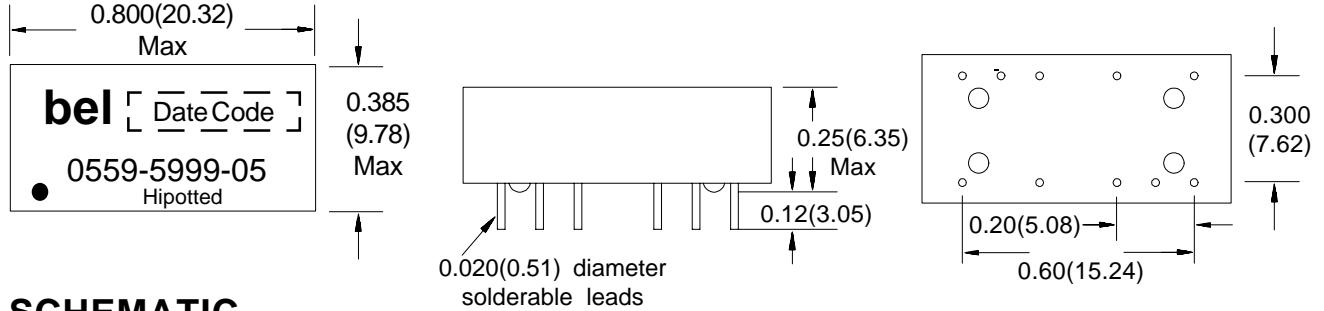

SCHEMATIC

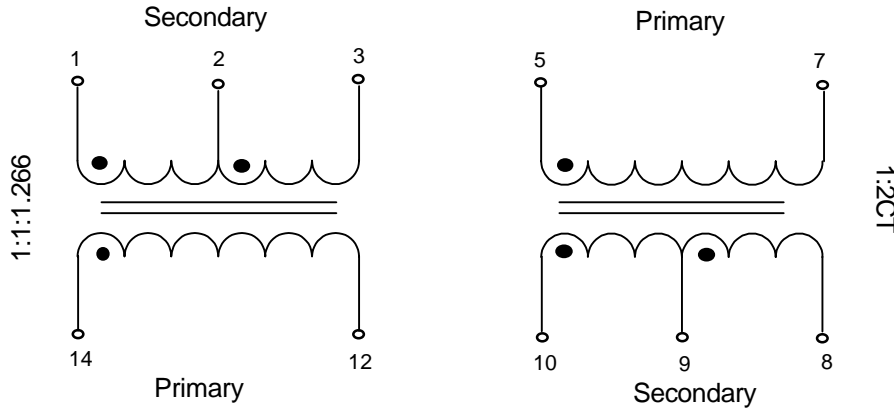

All dimensions are in in(mm).
Dimension tolerance is +/-0.02(0.51) unless otherwise specified.

Note: Pins (14-12) to Pins (1-3) is a 1:1.266 and Pins (14-12) to Pins (2-3) is a 1:1

ELECTRICALS @ 25° C

Part Number	Primary Inductance OCL (mH) Min		Leakage Inductance L_L (μ H) Max		Coupling Capacitance C_{wv} (pF) Max		DCR Ω (ohms) Max	
	Pins (5-7)	Pins (14-12)	Pins (5-7)	Pins (14-12)	Pins (14-1)	Pins (5-10)	Pins (5-7) to (14-12)	Pins (1-3) to (8-10)
0559-5999-05	1.2	1.5	0.4	0.5	35	40	0.7	1.1

Primary Inductance and Leakage Inductance measured at 100KHz, 20mV.

Corporate Office
Bel Fuse Inc.
198 Van Vorst Street, Jersey City, NJ 07302-4496
Tel: 201-432-0463
Fax: 201-432-9542
E-Mail: BelFuse@belfuse.com
Internet: http://www.belfuse.com

Far East Office
Bel Fuse Ltd.
8F/8 Luk Hop Street
San Po Kong
Kowloon, Hong Kong
Tel: 852-2328-5515
Fax: 852-2352-3706

European Office
Bel Fuse Europe Ltd.
Preston Technology Management Centre
Marsh Lane, Preston PR1 8UD
Lancashire, U.K.
Tel: 44-1772-556601
Fax: 44-1772-888366

T1 TRANSFORMER 0553-5841-00

TM0015

Bel offers a new T1 transformer. Precision winding in combination with semi-automated manufacturing processes provide a quality product.

- * 1000 Vrms Isolation.
- * Operating Temperature Range 0°C to 70°C.
- * Able to withstand aqueous washes.

SCHEMATIC

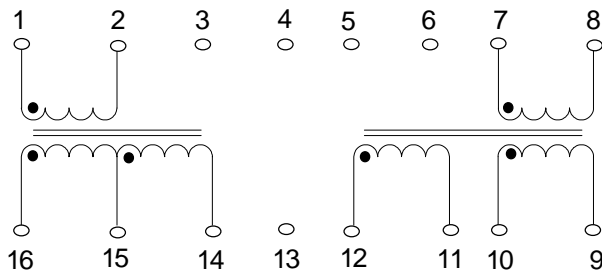

MECHANICALS

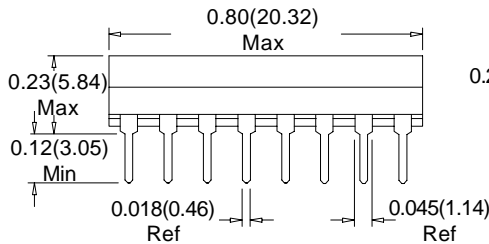
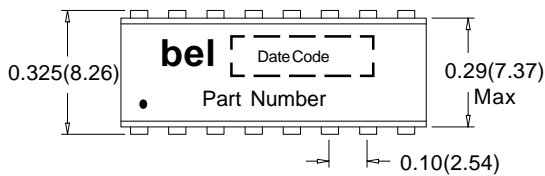

Cross Sectional Views

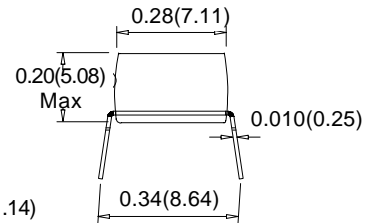

Dimensions are in inches(mm). Dimension tolerance is equal to +/- 0.01(0.25) unless otherwise stated.

ELECTRICALS @ 25° C.

Part Number	Turns Ratio (+/- 5%)		Inductance OCL (mH) Min	Leakage Inductance L_L (nH) Max		DCR (mohms) Max		Coupling Capacitance C_{ww} (pF) Max
	Pins (1-2):(16-14)	Pins (7-8):(12-11):(10-9)		Pins (1-2) tie Pins (7-8)	Pins (14,15,16)	Pins (7-8) tie Pins (9,10,11,12)	Pins (1-2) and Pins (7-8)	
0553-5841-00	1 : $\sqrt{2}$ CT	1 : 1 : 1	1.2	800	500	800	1100	35

Corporate Office

Bel Fuse Inc.
198 Van Vorst Street, Jersey City, NJ 07302-4496
Tel: 201-432-0463
Fax: 201-432-9542
E-Mail: BelFuse@belfuse.com
Internet: <http://www.belfuse.com>

Far East Office

Bel Fuse Ltd.
8F/8 Luk Hop Street
San Po Kong
Kowloon, Hong Kong
Tel: 852-2328-5515
Fax: 852-2352-3706

European Office

Bel Fuse Europe Ltd.
Preston Technology Management Centre
Marsh Lane, Preston PR1 8UD
Lancashire, U.K.
Tel: 44-1772-556601
Fax: 44-1772-888366

**ISDN TRANSFORMER
0553-0043-DC**

TM0016

Bel provides a new transformer to be used with the Echelon Lontalk applications.

* Primary Inductance is 3.5 mH minimum.

* Isolation Voltage - 1500Vrms.

**M
E
C
H
A
N
I
C
A
L
S**

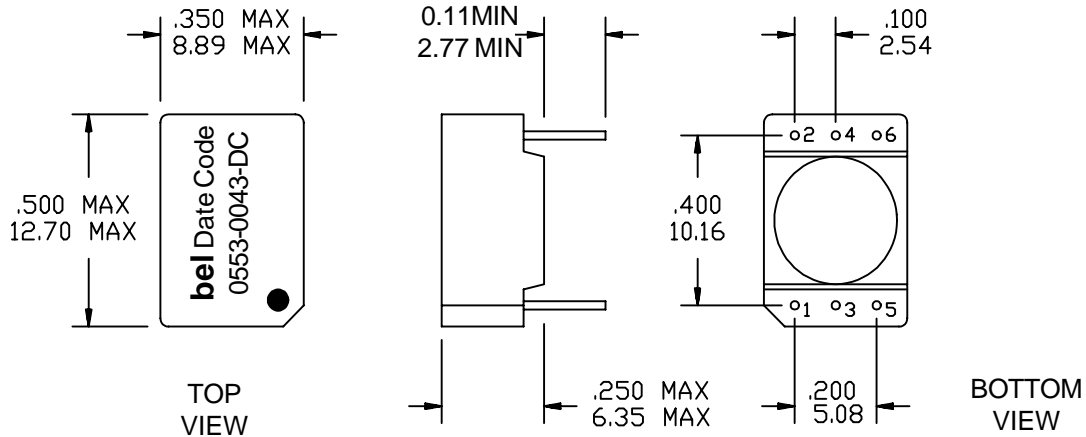

Dimensions in ^{inches}_(mm)
Dimension tolerance +/- 0.01(0.25) unless otherwise stated

SCHEMATIC

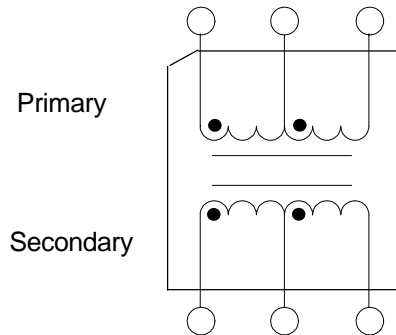

ELECTRICALS

Part Number	Primary Inductance OCL (μH) Min	Turns Ratio	DCR ohms (max)	
	Pins (1-5)	Pins (1-5):(2-6)	Pins (1-5)	Pins (2-6)
0553-0043-DC	3.5	1CT:1CT	0.5	0.5

Electricals @ 25° C.

Primary Inductance is measured at 20 mV @ 10 KHz..

Corporate Office

Bel Fuse Inc.
198 Van Vorst Street, Jersey City, NJ 07302-4496
Tel: 201-432-0463
Fax: 201-432-9542
E-Mail: BelFuse@belfuse.com
Internet: http://www.belfuse.com

Far East Office

Bel Fuse Ltd.
8F/8 Luk Hop Street
San Po Kong
Kowloon, Hong Kong
Tel: 852-2328-5515
Fax: 852-2352-3706

European Office

Bel Fuse Europe Ltd.
Preston Technology Management Centre
Marsh Lane, Preston PR1 8UD
Lancashire, U.K.
Tel: 44-1772-556601
Fax: 44-1772-888366

T1/CEPT/ISDN-PR1 TRANSFORMER 0553-0013-13

TM0017

Bel provides a new transformer to be used in multiple T1/CEPT/ISDN-Pri applications.

* Primary Inductance is 1.2 mH minimum.

* Isolation Voltage - 1500Vrms.

**M
E
C
H
A
N
I
C
A
L
S**

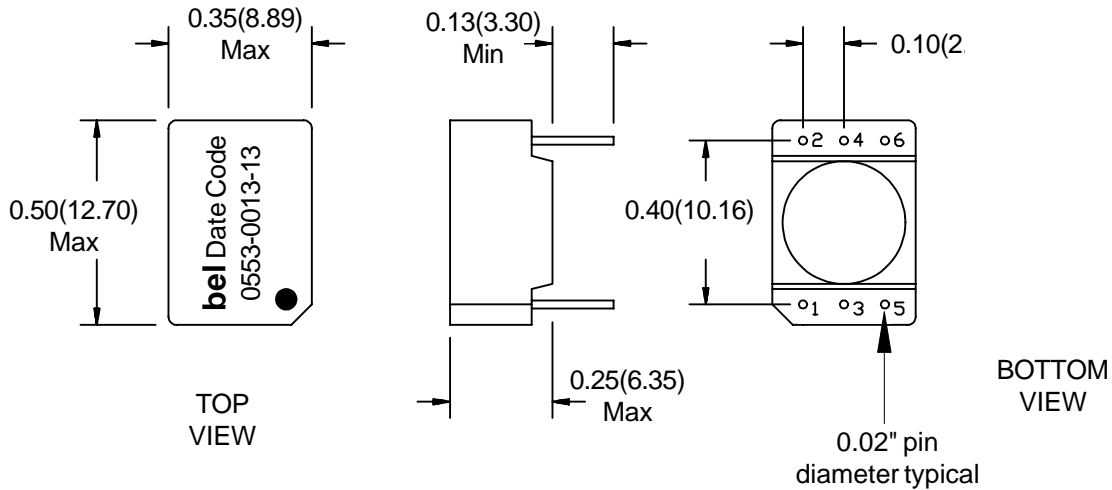

SCHEMATIC

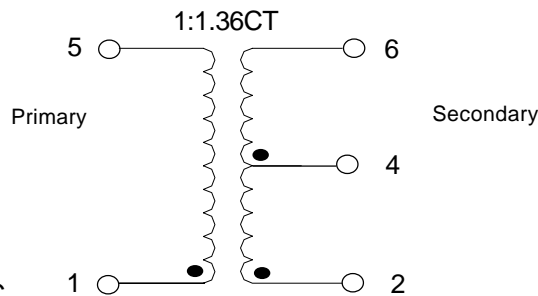

Dimensions in inches(mm)
 Dimension tolerance +/- 0.01(0.25)
 unless otherwise stated

ELECTRICALS @ 25° C.

Part Number	Primary Inductance OCL (mH) Min	Turns Ratio +/- 5%	Coupling Capacitance (pF) Max	Leakage Inductance L _l (μH) Max	DCR (ohms) Max	
		Pins (1-5):(2-6)			Pins (1-5)	Pins (2-6)
0553-0013-13	1.20	1:1.36CT	35	0.80	0.7	0.9

Corporate Office
 Bel Fuse Inc.
 198 Van Vorst Street, Jersey City, NJ 07302-4496
 Tel: 201-432-0463
 Fax: 201-432-9542
 E-Mail: BelFuse@belfuse.com
 Internet: http://www.belfuse.com

Far East Office
 Bel Fuse Ltd.
 8F/8 Luk Hop Street
 San Po Kong
 Kowloon, Hong Kong
 Tel: 852-2328-5515
 Fax: 852-2352-3706

European Office
 Bel Fuse Europe Ltd.
 Preston Technology Management Centre
 Marsh Lane, Preston PR1 8UD
 Lancashire, U.K.
 Tel: 44-1772-556601
 Fax: 44-1772-888366

T1/CEPT/ISDN-PR1 TRANSFORMER
0553-0013-14

Bel provides a new transformer to be used in multiple T1/CEPT/ISDN-Pri applications.

- * Primary Inductance is 1.5 mH minimum.
- * Isolation Voltage - 1500Vrms.

**M
E
C
H
A
N
I
C
A
L
S**

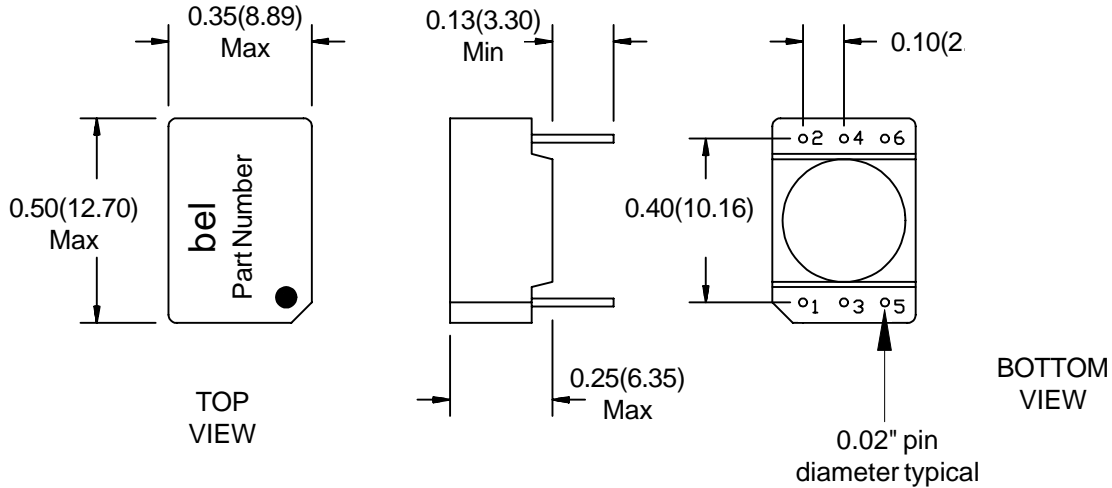

SCHEMATIC

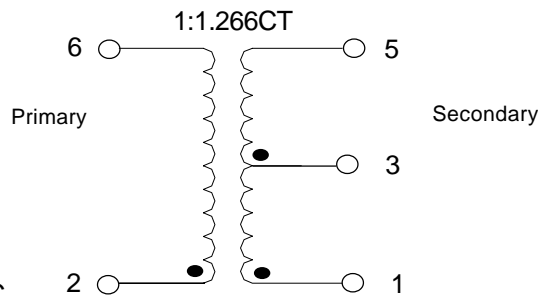

Dimensions in inches(mm)
 Dimension tolerance +/- 0.01(0.25)
 unless otherwise stated

ELECTRICALS @ 25° C.

Part Number	Primary Inductance OCL (mH) Min	Turns Ratio +/- 5% Pins (2-6):(1-5)	Coupling Capacitance (pF) Max	Leakage Inductance L_L (μH) Max	DCR (ohms) Max	
					Pins (1-5)	Pins (2-6)
0553-0013-14	1.50	1:1.266CT	18	0.80	0.80	0.92

Corporate Office
 Bel Fuse Inc.
 198 Van Vorst Street, Jersey City, NJ 07302-4496
 Tel: 201-432-0463
 Fax: 201-432-9542
 E-Mail: BelFuse@belfuse.com
 Internet: http://www.belfuse.com

Far East Office
 Bel Fuse Ltd.
 8F/8 Luk Hop Street
 San Po Kong
 Kowloon, Hong Kong
 Tel: 852-2328-5515
 Fax: 852-2352-3706

European Office
 Bel Fuse Europe Ltd.
 Preston Technology Management Centre
 Marsh Lane, Preston PR1 8UD
 Lancashire, U.K.
 Tel: 44-1772-556601
 Fax: 44-1772-888366

ISDN TRANSFORMER 0554-3855-00

TM0019

Bel provides a new transformer.

* Primary Inductance is 19 μ H minimum.

* Isolation Voltage - 3000Vrms.

MECHANICALS

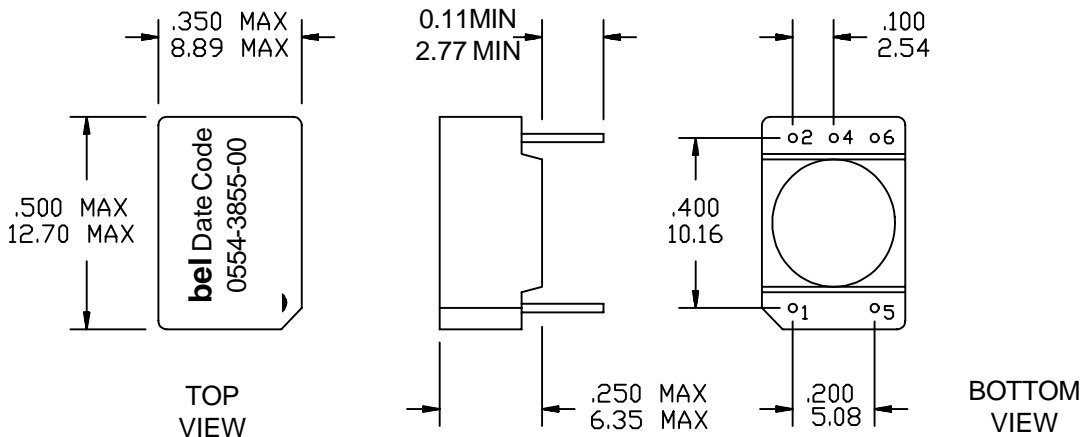

SCHEMATIC

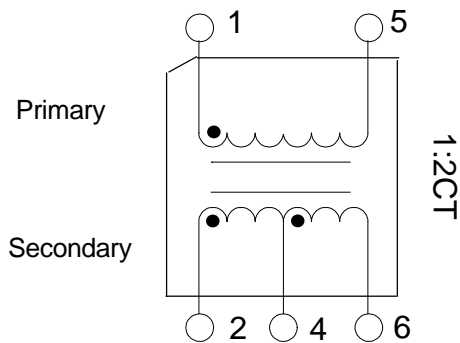

Dimensions in $\frac{\text{inches}}{(\text{mm})}$
Dimension tolerance +/- 0.01(0.25) unless otherwise stated

ELECTRICALS

Part Number	Primary Inductance OCL (μ H) Min	Turns Ratio	DCR ohms (max)	Leakage Inductance (μ H) Max	Coupling Capacitance (pF) Max	Isolation Voltage (Vrms) 1 Min
	Pins (1-5)	Pins (1-5):(2-6)	Pins (1-5)=(2-4)=(4-6)			
0554-3855-00	19	1:2CT	0.20	60	60	3000

Electricals @ 25° C. Primary Inductance is measured at 20 mVrms @ 100 KHz.
Leakage Inductance and Coupling Capacitance is measured at 100KHz, 10mVrms.

Corporate Office
Bel Fuse Inc.
198 Van Vorst Street, Jersey City, NJ 07302-4496
Tel: 201-432-0463
Fax: 201-432-9542
E-Mail: BelFuse@belfuse.com
Internet: http://www.belfuse.com

Far East Office
Bel Fuse Ltd.
8F/8 Luk Hop Street
San Po Kong
Kowloon, Hong Kong
Tel: 852-2328-5515
Fax: 852-2352-3706

European Office
Bel Fuse Europe Ltd.
Preston Technology Management Centre
Marsh Lane, Preston PR1 8UD
Lancashire, U.K.
Tel: 44-1772-556601
Fax: 44-1772-888366

T3/DS3/E3/STS-1 TRANSFORMERS

TM0020

Bel provides a small footprint transformer for use in multiple applications. It is available in both through hole and "pick and place compatible" SMD packaging.

* High Reliability and Low Cost

MECHANICALS

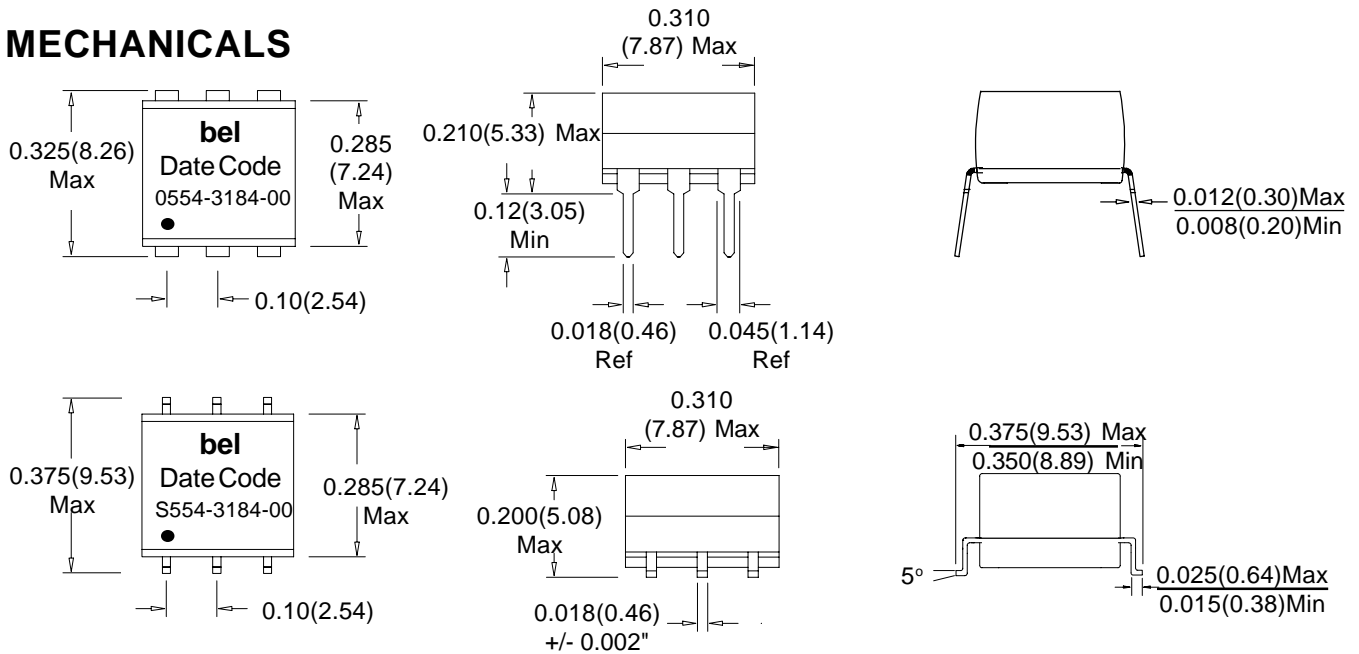

Dimensions are in inches (mm).
Dimension tolerance +/- 0.01(0.25) unless otherwise stated.

SCHEMATIC

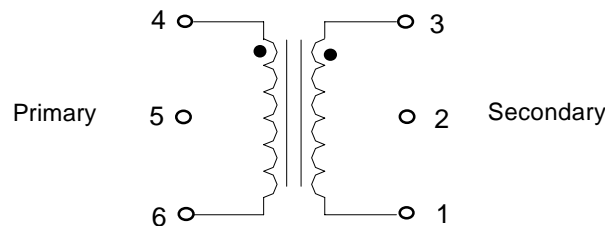

ELECTRICALS @ 25° C

Part Number	Turns Ratio +/- 5%	Primary Pins	Inductance OCL (μH) Min	Leakage Inductance L _L (μH) Max	Bandwidth (dB) Typ	Hipot (Vrms) @ 1 Sec
					200kHz-340MHz	
0554-3184-00	1:1	4-6	40	0.08	3	1500
S554-3184-00						

Corporate Office
Bel Fuse Inc.
 198 Van Vorst Street, Jersey City, NJ 07302-4496
 Tel: 201-432-0463
 Fax: 201-432-9542
 E-Mail: BelFuse@belfuse.com
 Internet: http://www.belfuse.com

Far East Office
Bel Fuse Ltd.
 8F/8 Luk Hop Street
 San Po Kong
 Kowloon, Hong Kong
 Tel: 852-2328-5515
 Fax: 852-2352-3706

European Office
Bel Fuse Europe Ltd.
 Preston Technology Management Centre
 Marsh Lane, Preston PR1 8UD
 Lancashire, U.K.
 Tel: 44-1772-556601
 Fax: 44-1772-888366

DS3/T3/E3/STS-1 TRANSFORMERS 0554-3184-01 and S554-3184-01

TM0021

Bel introduces two new "pick and place" compatible, small footprint, transformers designed to be used in multiple applications.

- * 1500 Vrms isolation
- * High Reliability and Low Cost

MECHANICALS

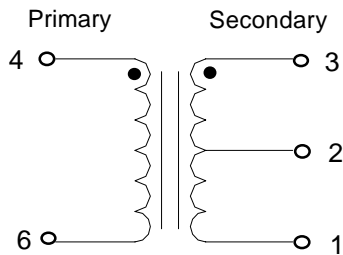
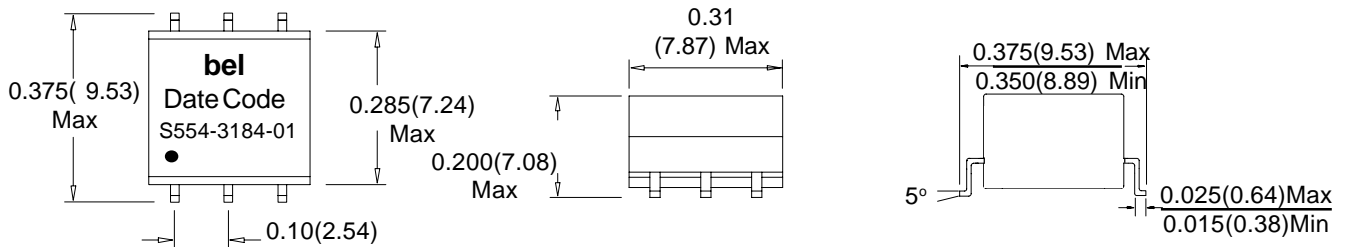
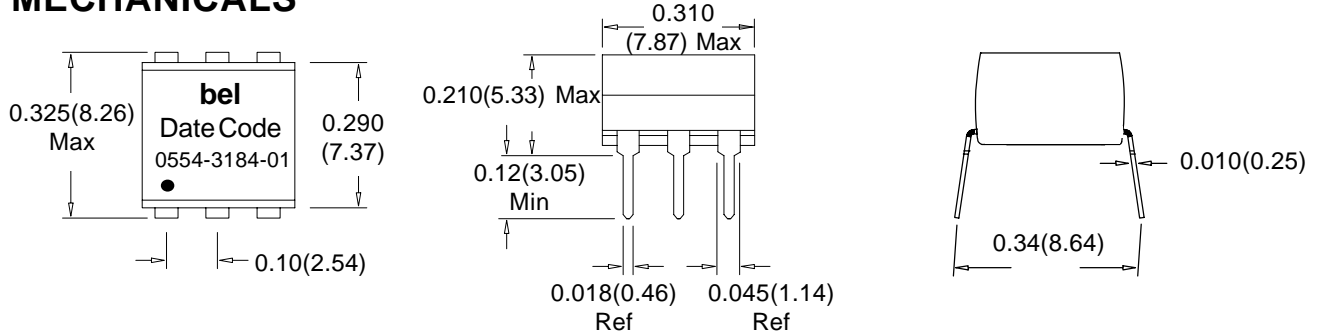

Dimensions are in inches (mm).
Dimension tolerance +/- 0.01(0.25) unless otherwise stated.

SCHEMATIC

ELECTRICALS @ 25° C

Part Number	Turns Ratio +/- 5%	Inductance OCL (μ H) Min	Leakage Inductance L_L (μ H) Max	Bandwidth (dB) Typ	Hipot (Vrms) @1 sec
				250kHz-500MHz	
0554-3184-01	1:2CT	19	0.06	3	1500
S554-3184-01	1:2CT	19	0.06	3	1500

Corporate Office
Bel Fuse Inc.
198 Van Vorst Street, Jersey City, NJ 07302-4496
Tel: 201-432-0463
Fax: 201-432-9542
E-Mail: BelFuse@belfuse.com
Internet: <http://www.belfuse.com>

Far East Office
Bel Fuse Ltd.
8F/8 Luk Hop Street
San Po Kong
Kowloon, Hong Kong
Tel: 852-2328-5515
Fax: 852-2352-3706

European Office
Bel Fuse Europe Ltd.
Preston Technology Management Centre
Marsh Lane, Preston PR1 8UD
Lancashire, U.K.
Tel: 44-1772-556601
Fax: 44-1772-888366

ISDN TRANSFORMERS T3 Applications

TM0022

Bel provides a small footprint transformer for use in multiple applications. It is available in both through hole and "pick and place compatible" SMD packaging.

* High Reliability and Low Cost

MECHANICALS

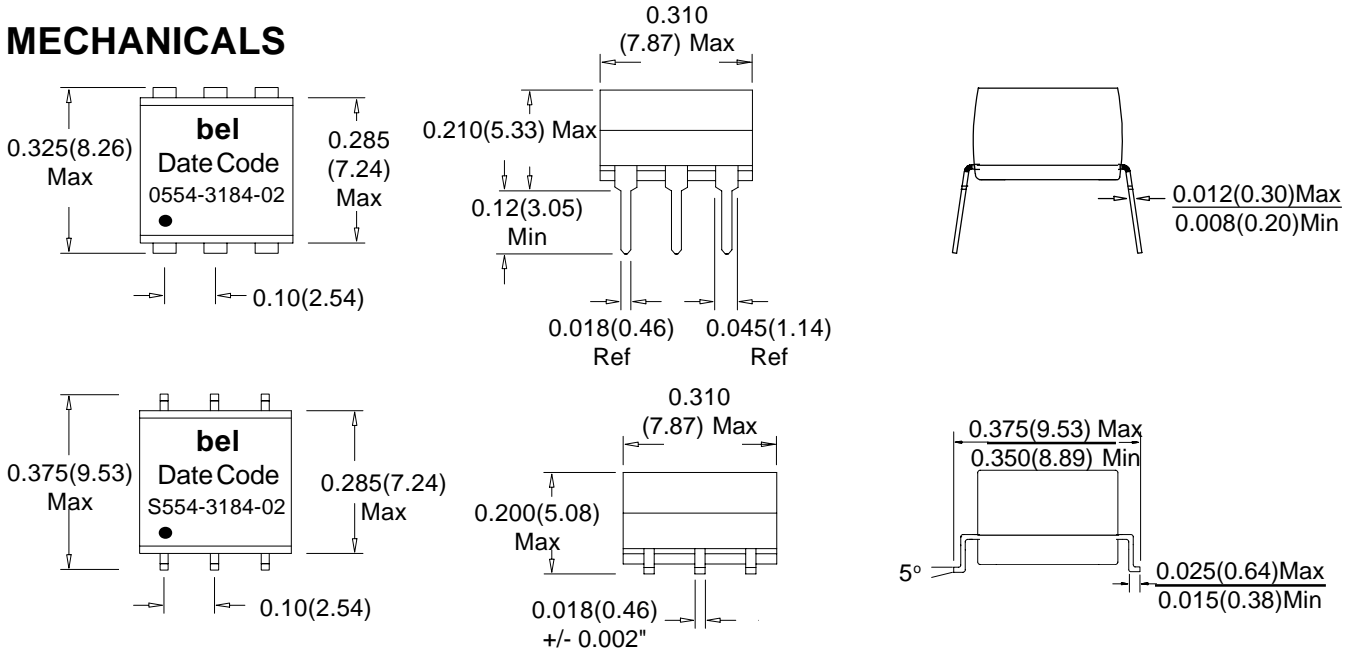

Dimensions are in inches (mm).
Dimension tolerance +/- 0.01(0.25) unless otherwise stated.

SCHEMATIC

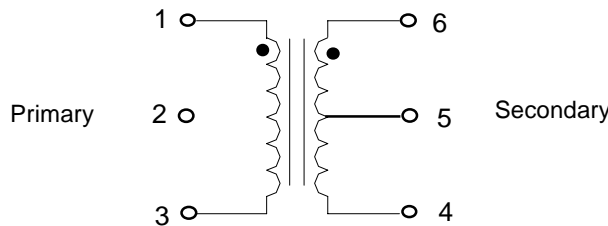

ELECTRICALS @ 25° C

Part Number	Turns Ratio +/- 5%	Primary Pins	Inductance OCL (μH) Min	Leakage Inductance L _L (μH) Max	DC Resistance DCR (ohms) Max		Interwinding Capacitance C _{ww} (pF) Max	Hipot (Vrms) @ 1 Sec
					Pins (1-3)	Pins (4-6)		
0554-3184-02	1:2CT	1-3	40	0.12	0.2	0.3	10	1500
S554-3184-02								

Corporate Office
Bel Fuse Inc.
 198 Van Vorst Street, Jersey City, NJ 07302-4496
 Tel: 201-432-0463
 Fax: 201-432-9542
 E-Mail: BelFuse@belfuse.com
 Internet: http://www.belfuse.com

Far East Office
Bel Fuse Ltd.
 8F/8 Luk Hop Street
 San Po Kong
 Kowloon, Hong Kong
 Tel: 852-2328-5515
 Fax: 852-2352-3706

European Office
Bel Fuse Europe Ltd.
 Preston Technology Management Centre
 Marsh Lane, Preston PR1 8UD
 Lancashire, U.K.
 Tel: 44-1772-556601
 Fax: 44-1772-888366

PULSE TRANSFORMERS S553-3855-01

TM0023

Bel takes this opportunity to supply a new Pulse Transformer for Digital Data Service. Our manufacturing processes assure quality and reliability in every component.

* Designed to work compatibly with the Level One LXT441 Transceiver.

* Designed for SW36 and DDS.

SCHEMATIC

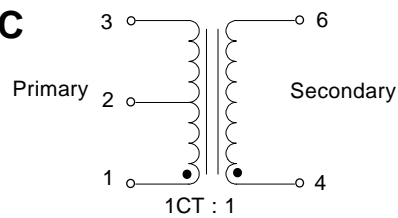

MECHANICALS

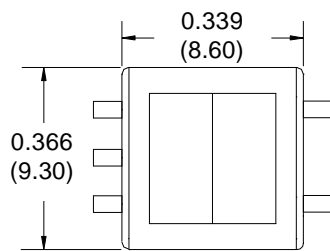

All dimensions are in inches(mm).
Dimension tolerance is +/- 0.01 unless otherwise stated.

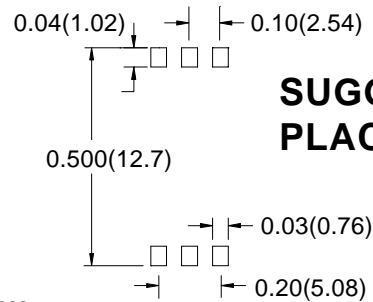
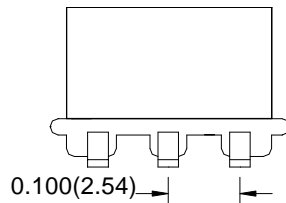

SUGGESTED PLACEMENT

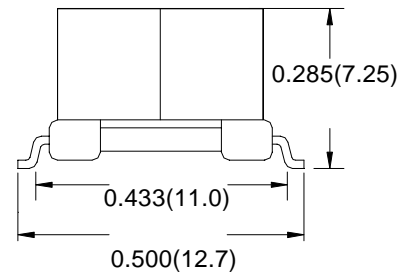

ELECTRICALS @ 25°C

Part Number	Turns Ratio +/- 2%	Primary Inductance (mH) Min	Leakage Inductance (μH) Max	Capacitance (pF) Max	DCR (ohms) +/- 10%	Return Loss (dB) Typ. vs. Line 2	Insertion Loss (dB) Typ.	Frequency Response (dB)
	Pins (3-1):(4-6)	Pins (3-1)	Pins (3-1)	Pins (3 to 4)	Pins (3-1) & Pins (4-6)	1kHz	10kHz	100Hz-112kHz
S553-3855-01	1CT:1	40	40	50	6	32	1.50	+/- 1.0

Part Number	Longitudinal Balance (dB) Typ.			DC Bias Current (mA) Min	Dielectric Strength (VAC)
	60Hz to 1000Hz	1000Hz to 4000Hz	15kHz to 2MHz		
S553-3855-01	60	40	40	50	1500

Corporate Office

Bel Fuse Inc.
198 Van Vorst Street, Jersey City, NJ 07302-4496
Tel: 201-432-0463
Fax: 201-432-9542
E-Mail: BelFuse@belfuse.com
Internet: <http://www.belfuse.com>

Far East Office

Bel Fuse Ltd.
8F/8 Luk Hop Street
San Po Kong
Kowloon, Hong Kong
Tel: 852-2328-5515
Fax: 852-2352-3706

European Office

Bel Fuse Europe Ltd.
Preston Technology Management Centre
Marsh Lane, Preston PR1 8UD
Lancashire, U.K.
Tel: 44-1772-556601
Fax: 44-1772-888366

TRANSFORMER
0557-0450-00

TM0024

Bel designs a transformer for multiple applications with a turns ratio of 1:1.8.

* 2000 Vrms Isolation Voltage

SCHEMATIC

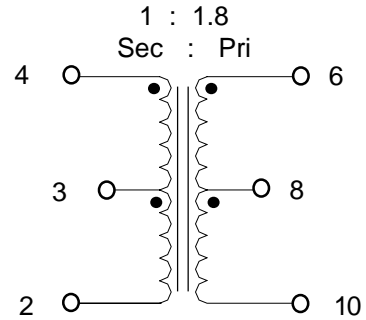

MECHANICALS

Phenolic add to be inserted and glued flush with top and bottom of the transformer core halves.

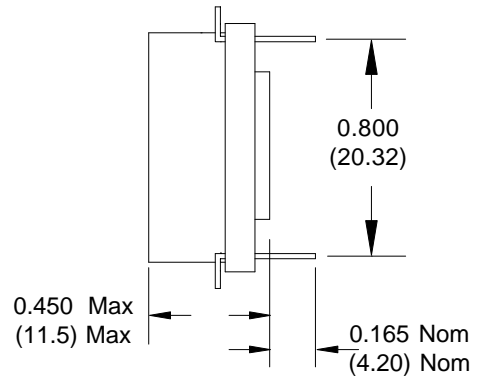
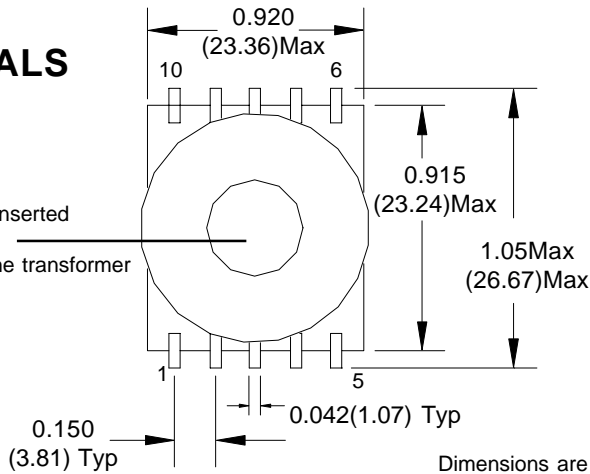

Dimensions are in inches (mm).
Dimension tolerance +/- 0.01(0.25) unless otherwise stated.

ELECTRICALS @ 25° C

Part Number	Turns Ratio (+/- 2%)	Inductance (mH) +/- 3%	Leakage Inductance (µH) Max	Coupling Capacitance (pF) Max	DCR (Ω) Max		Hipot (Vrms)
					Pins (6-10)	Pins (4-2)	
0557-0450-00	1 : 1.8	2.81	200	40	5.2	3.0	2000

Leakage Inductance is measured with Pins (4-2) tied.
Inductance, Leakage Inductance, and Coupling Capacitance tested at 10KHz, 0.1V.

Corporate Office
Bel Fuse Inc.
198 Van Vorst Street, Jersey City, NJ 07302-4496
Tel: 201-432-0463
Fax: 201-432-9542
E-Mail: BelFuse@belfuse.com
Internet: http://www.belfuse.com

Far East Office
Bel Fuse Ltd.
8F/8 Luk Hop Street
San Po Kong
Kowloon, Hong Kong
Tel: 852-2328-5515
Fax: 852-2352-3706

European Office
Bel Fuse Europe Ltd.
Preston Technology Management Centre
Marsh Lane, Preston PR1 8UD
Lancashire, U.K.
Tel: 44-1772-556601
Fax: 44-1772-888366

T1/CEPT/ISDN-PRI TRANSFORMER

0553-6500-04

TM0045

Bel provides a new transformer to be used in multiple T1/CEPT/ISDN-Pri applications.

* Primary Inductance is 1.5 mH minimum.

* Isolation Voltage - 1500Vrms.

**M
E
C
H
A
N
I
C
A
L
S**

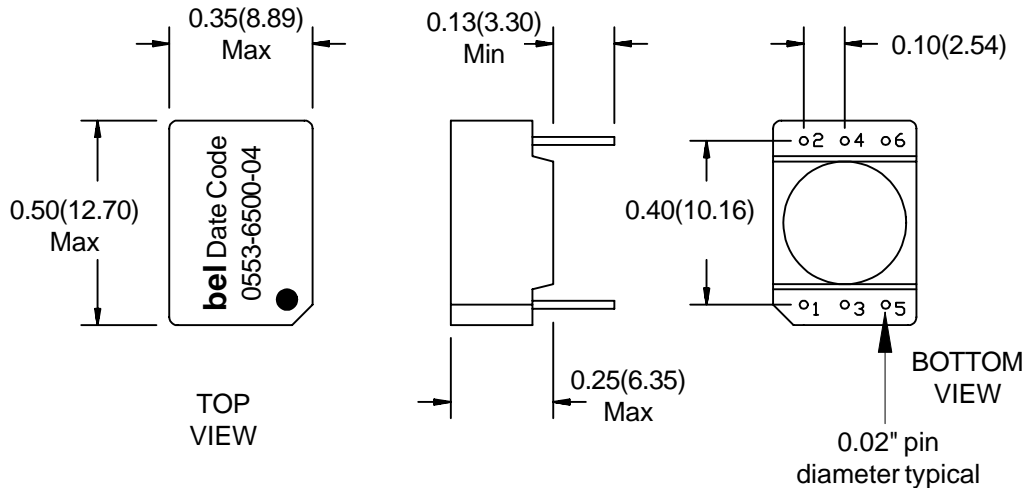

SCHEMATIC

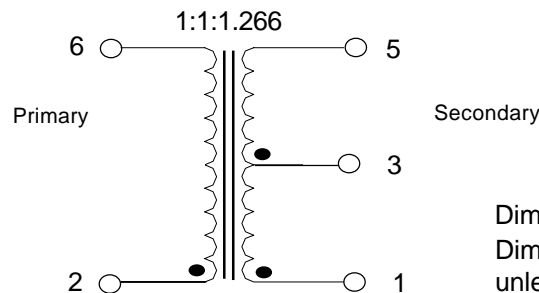

Dimensions in inches(mm)
Dimension tolerance +/- 0.01(0.25) unless otherwise stated

ELECTRICALS @ 25° C.

Part Number	Primary Inductance OCL (mH) Min	Turns Ratio +/- 5%	Coupling Capacitance (pF) Max	Leakage Inductance L _L (μH) Max	DCR (ohms) Max	
		Pins (2-6):(3-5):(1-5)			Pins (2-6)	Pins (1-5)
0553-6500-04	1.50	1:1:1.26	35	0.40	0.7	0.9

Corporate Office
Bel Fuse Inc.
 198 Van Vorst Street, Jersey City, NJ 07302-4496
 Tel: 201-432-0463
 Fax: 201-432-9542
 E-Mail: BelFuse@belfuse.com
 Internet: http://www.belfuse.com

Far East Office
Bel Fuse Ltd.
 8F/8 Luk Hop Street
 San Po Kong
 Kowloon, Hong Kong
 Tel: 852-2328-5515
 Fax: 852-2352-3706

European Office
Bel Fuse Europe Ltd.
 Preston Technology Management Centre
 Marsh Lane, Preston PR1 8UD
 Lancashire, U.K.
 Tel: 44-1772-556601
 Fax: 44-1772-888366

DATA COUPLING "T" CASE TRANSFORMERS

TM0051

SCHEMATICS AND MECHANICALS

SCHEMATICS

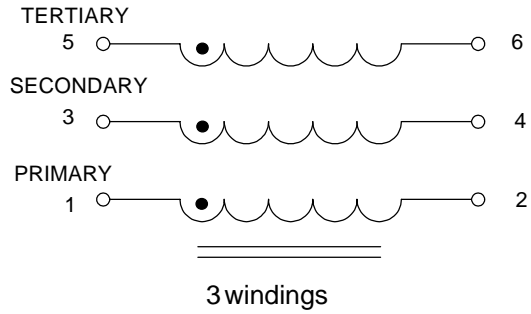
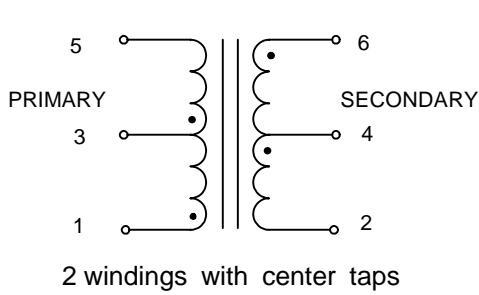

MECHANICALS - T CASE PACKAGE STYLE

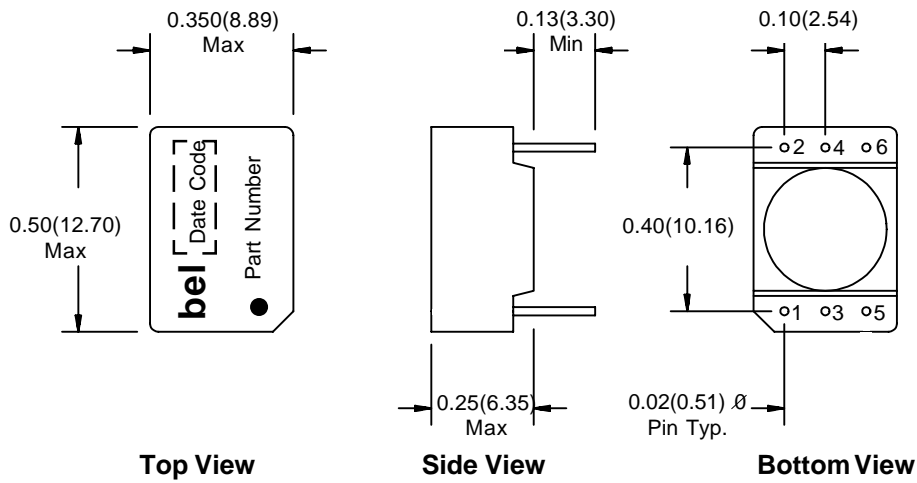

Dimensions are in inches (mm).
Dimension Tolerance is
+/- 0.01(0.25) unless
otherwise specified.

DATA COUPLING "T" CASE TRANSFORMERS

TM0051

The "T" case LAN networking transformers are designed to be used as small form, discreet components for isolation and impedance matching. Custom designs are also available upon request.

- * 2000 Vrms Isolation.
- * Discreet isolation protection and AUI applications.
- * Will withstand aqueous washes.

ELECTRICALS @ 25° C

Part Number	Turns Ratio (+/- 5%)	Inductance Lp (μH)Min	ET Constant (Vμs) Min	Rise Time (ns) Max	Coupling Capacitance C _{ww} (pF) Max	Leakage Inductance L _L (μH) Max	Pri DCR (ohms) Max	Sec DCR (ohms) Max	Tertiary DCR (ohms) Max
0553-0053-IC	1:1:1	5,000	25.0	10.5	60	1.3	3.9	3.9	3.9
0553-0023-IC	1:1:1	2,000	16.0	8.2	37	0.8	2.5	2.5	2.5
0553-0013-IC	1:1:1	1,000	11.0	8.0	30	0.7	2.0	2.0	2.0
0553-5006-IC	1:1:1	500	8.5	5.3	32	0.4	1.3	1.3	1.3
0553-2006-IC	1:1:1	200	5.0	4.2	18	0.3	0.9	0.9	0.9
0553-1006-IC	1:1:1	100	5.0	5.6	15	0.5	1.0	1.0	1.0
0553-0506-IC	1:1:1	500	5.2	5.6	18	0.5	1.3	1.3	1.3
0553-0206-IC	1:1:1	20	3.2	4.1	21	0.4	0.9	0.9	0.9
0553-0106-IC	1:1:1	10	3.7	5.1	22	0.5	0.9	0.9	0.9
0553-0053-PC	2:1:1	5,000	25.0	16.0	33	3.6	3.9	2.0	2.0
0553-0023-PC	2:1:1	2,000	16.0	11.0	19	1.8	2.5	1.4	1.4
0553-5006-PC	2:1:1	500	8.5	5.6	11	1.1	1.3	0.7	0.7
0553-2006-PC	2:1:1	200	5.0	3.2	8	0.8	0.9	0.5	0.5
0553-0206-PC	2:1:1	20	5.8	7.5	12	1.5	1.3	0.8	0.8
0553-2006-QC	3:1:1	200	5.0	3.6	7	1.1	0.9	0.4	0.4
0553-0206-QC	3:1:1	20	3.2	2.7	6	1.3	0.9	0.4	0.4
0553-0023-DC	1CT:1CT	2,000	16.0	8.2	37	0.8	2.5	2.5	--
0553-0013-DC	1CT:1CT	1,000	11.0	8.0	30	0.7	2.0	2.0	--
0553-5006-DC	1CT:1CT	500	8.5	5.3	32	0.4	1.3	1.3	--
0553-2006-DC	1CT:1CT	200	5.0	4.2	18	0.3	0.9	0.9	--
0553-0506-DC	1CT:1CT	50	5.2	5.6	18	0.5	1.3	1.3	--
0553-0206-DC	1CT:1CT	20	3.2	4.1	21	0.4	0.9	0.9	--
0553-0106-DC	1CT:1CT	10	3.7	5.1	22	0.5	0.9	0.9	--
0553-0023-OC	2CT:1CT	2,000	16.0	11.0	19	1.8	2.5	1.4	--
0553-5006-OC	2CT:1CT	500	8.5	5.6	12	1.2	1.4	0.8	--
0553-2006-OC	2CT:1CT	200	5.0	3.2	8	0.8	0.9	0.5	--
0553-0506-OC	2CT:1CT	50	5.2	5.2	12	1.3	1.3	0.7	--
0553-0206-OC	2CT:1CT	20	5.8	7.5	12	1.5	1.3	0.8	--
0553-0106-OC	2CT:1CT	10	3.7	4.5	9	1.5	0.9	0.5	--

Mechanical Diagrams and Schematics are located on the facing page.

Corporate Office

Bel Fuse Inc.
 198 Van Vorst Street, Jersey City, NJ 07302-4496
 Tel: 201-432-0463
 Fax: 201-432-9542
 E-Mail: BelFuse@belfuse.com
 Internet: http://www.belfuse.com

Far East Office

Bel Fuse Ltd.
 8F/8 Luk Hop Street
 San Po Kong
 Kowloon, Hong Kong
 Tel: 852-2328-5515
 Fax: 852-2352-3706

European Office

Bel Fuse Europe Ltd.
 Preston Technology Management Centre
 Marsh Lane, Preston PR1 8UD
 Lancashire, U.K.
 Tel: 44-1772-556601
 Fax: 44-1772-888366