



**SA2531 A/B/C/D/E/F/G/J/U**

---

**VERSATILE SINGLE CHIP TELEPHONE  
WITH 14 NUMBER REPERTORY DIALLER**

---

**FEATURES**

- Speech circuit, LD/MF Repertory Dialler and Tone Ringer on one 28 pin CMOS chip
- Net 4 compatible
- Soft clip to avoid harsh distortion
- Line Loss Compensation selectable by pin option
- Power down mode
- Versatile applications for different PTT demands
- 31 digit last number redial
- Sliding Cursor protocol with comparison
- 2 Flash keys, 100 ms and 280 ms (option 600 ms)
- Ring frequency discrimination
- Operating range from 13 to 100 mA (down to 5 mA with reduced performance)
- Volume control of receive signal (Except "D")
- Low noise (max. -72dBmp)
- Real or Complex impedance on chip programmable
- LD/MF switchable dialling
- 14 memories, 4 direct/10 indirect or 10 direct
- Pause key for 2, 3 or 6 sec Auto Pause or Wait function
- On chip MF filter (CEPT CS 203 compatible)
- 3-tone melody generator

**GENERAL DESCRIPTION**

The SA2531 is a CMOS integrated circuit that contains all the functions needed to form a high performance electronic telephone.

The device incorporates LD/MF repertory dialling, melody generation, ring frequency discrimination and a high quality speech circuit.

A RAM is on chip for a 31 digit last number redial and 14 memories each containing up to 21 digits. The sliding cursor procedure makes Last Number Redial easy behind a PABX.

The SA2531 (except the SA2531D) incorporates a volume control for the earpiece. The receive volume can be controlled by the VOL key (+4dB) or by the +/- keys (+6dB/-4dB in 5 steps).

The versatility of the circuit is provided by on chip programmability and a few external components. This allows easy adaption to different PTT requirements without changing the PCB of the telephone.

**PACKAGE**

Available in 28 pin DIP and PLCC

**PIN CONFIGURATIONS**

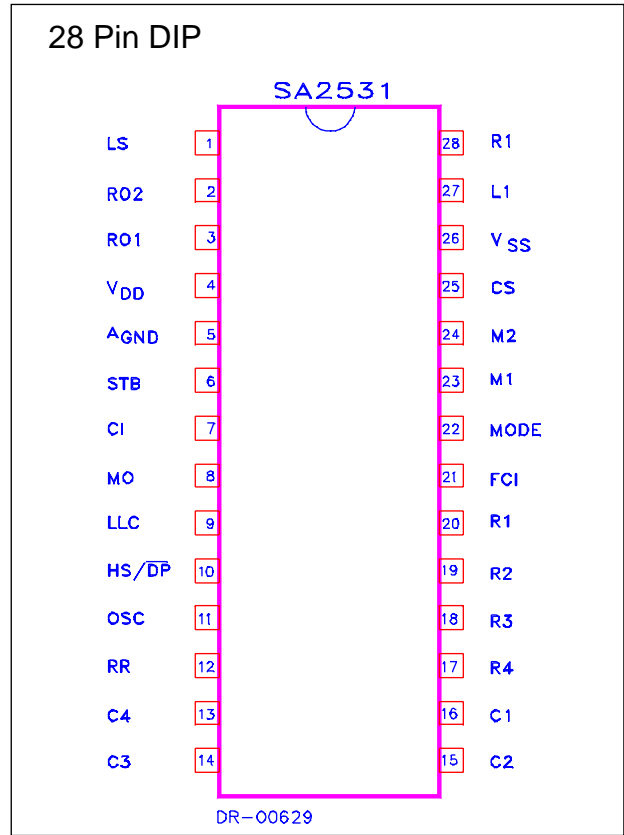
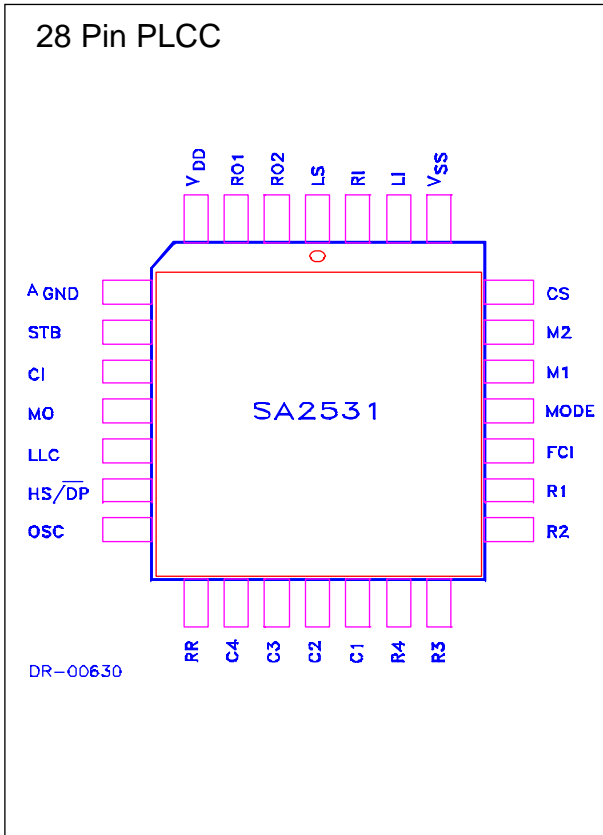

**PIN DESCRIPTION**

Pin#	Symbol	Function
23	M1	<b>Microphone Inputs</b>
24	M2	Differential inputs for the microphone (electret).
3	RO1	<b>Receiver Outputs</b>
2	RO2	These are the outputs for driving a dynamic earpiece with an impedance of 150 to 300Ω
5	A <sub>GND</sub>	<b>Analogue Ground</b> This is the analog ground for the amplifiers.
28	RI	<b>Receive Input</b> This is the input for the receive signal.
6	STB	<b>Side Tone Balance Input</b> This is the input for side tone cancellation.
1	LS	<b>Line Current Sense Input</b> This is the input for sensing the line current.
27	LI	<b>Line Input</b> This input is used for power extraction and line current sensing.

Pin#	Symbol	Function								
25	CS	<b>Current Shunt Control Output</b> This N-channel open drain output controls the external high power shunt transistor for the modulation of the line voltage and for shorting the line during make period of pulse dialling.								
4	V <sub>DD</sub>	<b>Positive Voltage Supply</b> This is the supply pin for the circuit.								
26	V <sub>SS</sub>	<b>Negative Power Supply</b>								
8	MO	<b>Melody Output</b> Pulse Density Modulated output of the melody generator for tone ringer. At high impedance when not active.								
21	FCI	<b>Frequency Comparator Input</b> This is a Schmitt trigger input for ring frequency discrimination. Disabled during off-hook.								
10	HS/DP	<b>Hook Switch Input and Dial Pulse Output</b> This is an I/O that is pulled high by the hook switch when off-hook. An open drain pulls it low during break periods of pulse dialling and flash.								
11	OSC	<b>Oscillator Input</b> Oscillator pin for Xtal or ceramic resonator (3.58 MHz). Recommended part is the Murata CSA3.5MG312AM.								
9	LLC	<b>Line Loss Compensation</b> Select pin for the loss compensation. OPEN = None      V <sub>DD</sub> = 45-75mA      V <sub>DD</sub> = 20-50mA								
12	RR	<b>Repetition Rate</b> Select pin for repetition rate of melody for the Tone ringer.								
22	MODE	<b>Signalling Mode Select Input</b> <table border="1" data-bbox="400 1301 1370 1473"> <thead> <tr> <th>Mode pin</th> <th>Function</th> </tr> </thead> <tbody> <tr> <td>High</td> <td>LD mode, 10pps, M:B = 33:66 (J:20pps)</td> </tr> <tr> <td>Open</td> <td>MFonly</td> </tr> <tr> <td>Low</td> <td>LD mode, 10pps, M:B = 40:60 (J:20pps, M:B = 33:66)</td> </tr> </tbody> </table>	Mode pin	Function	High	LD mode, 10pps, M:B = 33:66 (J:20pps)	Open	MFonly	Low	LD mode, 10pps, M:B = 40:60 (J:20pps, M:B = 33:66)
Mode pin	Function									
High	LD mode, 10pps, M:B = 33:66 (J:20pps)									
Open	MFonly									
Low	LD mode, 10pps, M:B = 40:60 (J:20pps, M:B = 33:66)									
20	R1	<b>Keyboard Rows</b>								
19	R2									
18	R3									
17	R4									
16	C1	<b>Keyboard Columns</b>								
15	C2									
14	C3									
13	C4									
7	CI	<b>Complex Impedance Input</b> Input pin for the capacitor in the complex impedance								



## FUNCTIONAL DESCRIPTION

### Power On Reset

The on chip power on reset circuit monitors the supply voltage ( $V_{DD}$ ). When  $V_{DD}$  rises above approx. 1.2V, a power on reset occurs to assure correct start-up and the RAM is cleared.

### DC Conditions

The normal operating range is from 13mA to 100 mA. Operating range with reduced performance is from 5mA to 13mA. In the operating range all functions are operational.

At line currents below 13mA the SA2531 provided an additional scope below 4.5V to allow parallel operation. (See Figure 12).

The dc characteristic (excluding diode bridge and Pulsing transistors) is determined by the voltage at LI and the resistor R1 as follows:

$$VLS = VLI + I_{Line} \cdot R1$$

The voltage at LI is 4.5V.

During pulse dialling the speech circuit and other parts of the device not required are in a power down mode to save current. The CS pin is pulled to  $V_{SS}$  in order to turn the external shunt transistor on to keep a low voltage drop at the LS pin during make periods.

### AC Impedance

The Characteristic or Output impedance of the SA2531 is set within the IC and adjusted by Mask Options. Available options are for 600 $\Omega$  and 1000 $\Omega$ . When the 1000 $\Omega$  option is selected then a capacitor may be added to the circuit at pin CI to add a reactive element and make the output impedance complex.

### Oscillator

All the Timing Functions of the SA2531 are based on a Clock Frequency of 3.58MHz. A crystal or ceramic resonator of this frequency should be connected to the OSC pin. In practise minor deviations from the nominal frequency may occur due to the characteristics of the frequency reference device used and so it is recommended that care is taken in the selection of components.

Typically a small value capacitor ( $\leq 47$ pF) should be connected in parallel with the Frequency Reference to ensure start-up and/or operation at the nominal frequency.

### Speech Circuit

The speech circuit consists of a transmit and a receive path born with soft clip, mute, line loss compensation and side tone cancellation.

#### Transmit

The gain of the transmit from M1/M2 to LS is 35dB for 600 $\Omega$  versions and 37dB for 1000 $\Omega$  versions (see test circuit figure 5). The microphone input is differential with an input impedance of 25 k $\Omega$ .

The soft clip circuit limits the output voltage at LI to 2.0V<sub>PEAK</sub> (see figures 8 & 9). The attack time is 30 $\mu$ s/6dB and the decay time is 20 ms/6 dB. When mute is active, during dialling

or after pressing the MUTE key, the gain is reduced by > 60 dB.

### Receive

The receive input is the differential signal of RI and STB. The gain of the receive path is 2 dB (test circuit figure 5) with differential outputs, RO1/RO2 (0dB on 1000Ω versions). When mute is active during dialling the gain is reduced by > 60dB. During DTMF dialling a MF comfort tone is applied to the receiver. The comfort tone is the DTMF signal with a level that is -30dB relative to the line signal.

The receive gain can be adjusted under user control by using the volume control keys (not on SA2531D). The VOL key gives a 4dB increase or returns the gain to normal in a Toggle Function. Alternatively the + and - keys may be used. The + key increases the gain to a maximum of +6dB while the - key reduces the gain to a minimum of -4dB. Each press of the keys changes the gain by approximately 2dB.

The gain is reset by the next on-hook.

### Side Tone

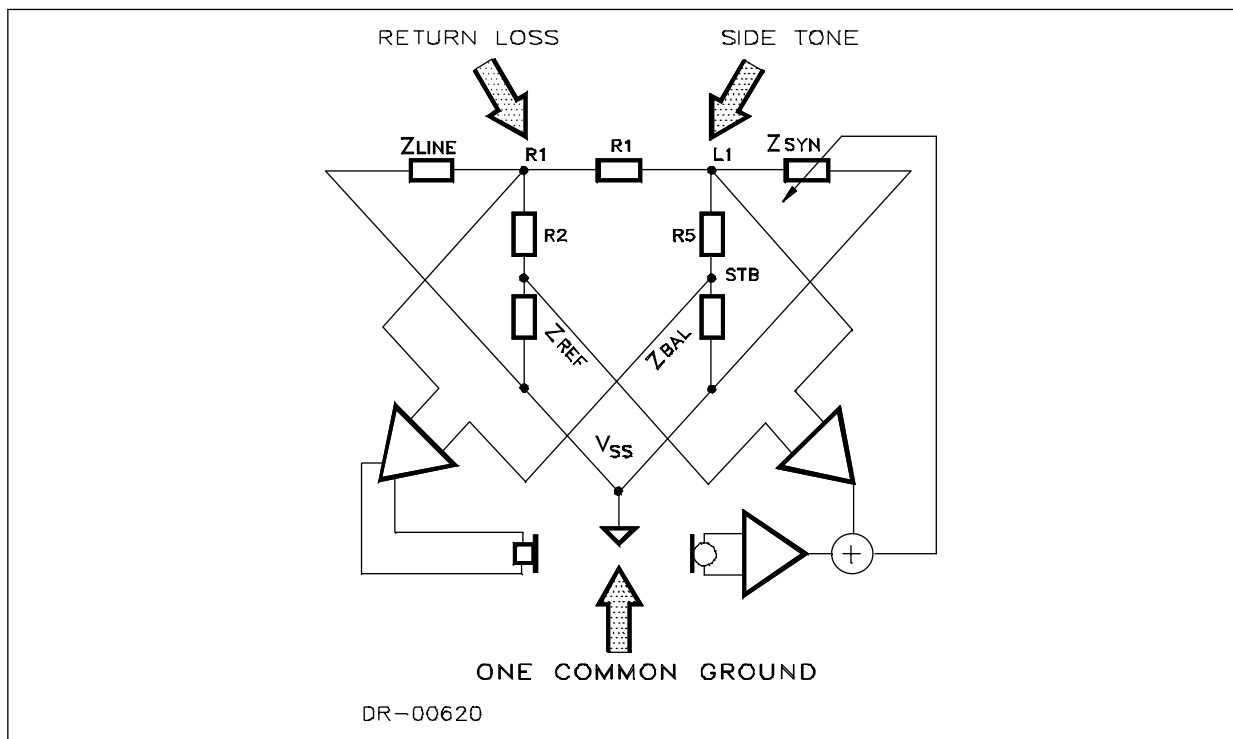

Side Tone is controlled along with Return Loss by a Double Balance Bridge as shown in Fig. 1.

**Figure 1**

Double balance bridge (return loss and side tone) with one common ground

A good side tone cancellation is achieved by using the following equation:

$$\frac{Z_{BAL}}{Z_{LINE}} = \frac{R5}{R1}$$

The side tone cancellation signal is applied to the STB input.

### Line Loss Compensation

When Line Loss Compensation is active the gain of the Transmit and Receive amplifiers are changed by 6dB in accordance with the DC conditions as measured at Pins LI and LS. When the LLC Pin is Low this adjustment in gain occurs over the range  $I_{LINE} = 20$  to 50 mA. When LLC is High the range is 45 to 75mA. Note that these figures apply for  $R1 = R30\Omega$ .

When the LLC Pin is open the amplifier gains remain fixed regardless of the Line Current (see figures 6 & 7).

## Dialling Functions

### Valid Keys

The keypad of the SA2531 comprises a maximum of 32 keys some of which are provided to cater for options (such as the two Recall/Flash periods). A Bi-polar scan technique is used so that the 32 keys are scanned in a 4 x 8 matrix using only 8 pins. Two explanatory keypad arrangements are illustrated in Figures 2 & 3.

A valid key is detected when one and only one contact closure is detected between a Row and Column Pin. Key contacts are debounced to avoid incorrect detection.

It is also possible to drive the keypad inputs with a micro controller.

### Dial Mode Selection

The default mode (LD or MF) can be selected by the Mode pin. When default LD mode is selected, a temporary change to MF can be invoked by pressing the \* key. The circuit will revert to LD by pressing the **R** (or **R2**) key or by next on-hook.

When MF mode is selected by the mode pin, the circuit can not be changed temporary to LD but will remain in MF.

### Last Number Redial

LNR is a facility that allows resignalling of the last manually dialled number without keying in all the digits again. The LNR is repeatable.

The current contents of the RAM are overwritten by new entries.

A manually entered number is automatically stored in the LNR RAM. The capacity of the RAM is 31 digits. If a number greater than 31 digits is entered, the LNR facility will be inhibited (Until new entries < 32 digits) and further entries will be buffered in a First In First Out Memory (FIFO).

Post dialled digits, i.e. digits manually entered after LNR has been invoked, are not stored in RAM but buffered in FIFO.

Pauses can be inserted by pressing the PAUSE key. (Further details of the Pause Function are included in the Memory Keys section.)

### Recall Function

A Recall (**R** key or **R2** key) activation will invoke a Flash (Timed Loop Break).

If Recall is the first entry in a digit string, it will be stored in LNR RAM when digit(s) are entered after the Recall.

If the recall key is depressed after a digit string has been entered or dialled out, the recall will not be stored but buffered in the FIFO together with subsequently entered digits.

If pressing the recall key is not followed by digit entries, the LNR RAM remains intact.

After a recall a pause of 27µms or 3 seconds will automatically be executed.

On versions C/C/E/G a recall cannot be executed in LD mode.

### Memory Keys

The keys **M1** to **M10** are direct memory access keys and the **MEM** key is used for indirect or abbreviated dialling.

In the on chip RAM, 14 numbers can be stored. Each number can contain up to 21 digits (including pauses).

During programming multiple pauses can be inserted by pressing the **PAUSE** key or the LNR key. Each pause is 3 seconds (optionally 6 or 2 seconds) when inserted within the first 5 digits otherwise a wait function that will halt dialling until the **PAUSE** key or the **LNR** key is depressed.

Memory dialling is cascadable. However, the content of one memory must be dialled out before a new one can be invoked.

### Mute Function

The MUTE key is enabled in speech mode only. Depressing the MUTE key mutes the microphone amplifier. Reprising the MUTE key deactivates the mute (toggle function). Any key entry overwrites a mute activated by the MUTE key and mute will be deactivated.

When privacy mute is activated a reminder tone is applied to the earpiece.

### Sliding Cursor Procedure

To accommodate easy and uncomplicated redialling (LNR) behind a PABX, a sliding cursor protocol is implemented. If new entries match the previous RAM contents, pressing the **LNR** key will dial out the remaining digits.

If there is an error in matching, the LNR will be inhibited until next on-hook, and the RAM will contain the new number.

**Tone Generator**

The tone generator incorporates the DTMF tones and 3 basic frequencies for the tone ringer.

**DTMF Tones**

The DTMF Tone Generator creates 12 Tones in compliance with CCITT Recommendation Q23. Signal levels are altered by Mask Option. High group frequencies have a level 2.6dB higher than those of the Low Group.

Details of the DTMF Tones are:

Low group

Digit 1-2-3	697Hz	(Error = -.074%)
Digit 4-5-6	770Hz	(Error = -.679%)
Digit 7-8-9	852Hz	(Error = -.621%)
Digit *-0-#	941Hz	(Error = +.139%)

High group

Digit 1-4-7-*	1209Hz	(Error = +.533%)
---------------	--------	------------------

**KEYBOARD ARRANGEMENT 1**

10 Direct memories (either **VOL** or **+/-** keys)

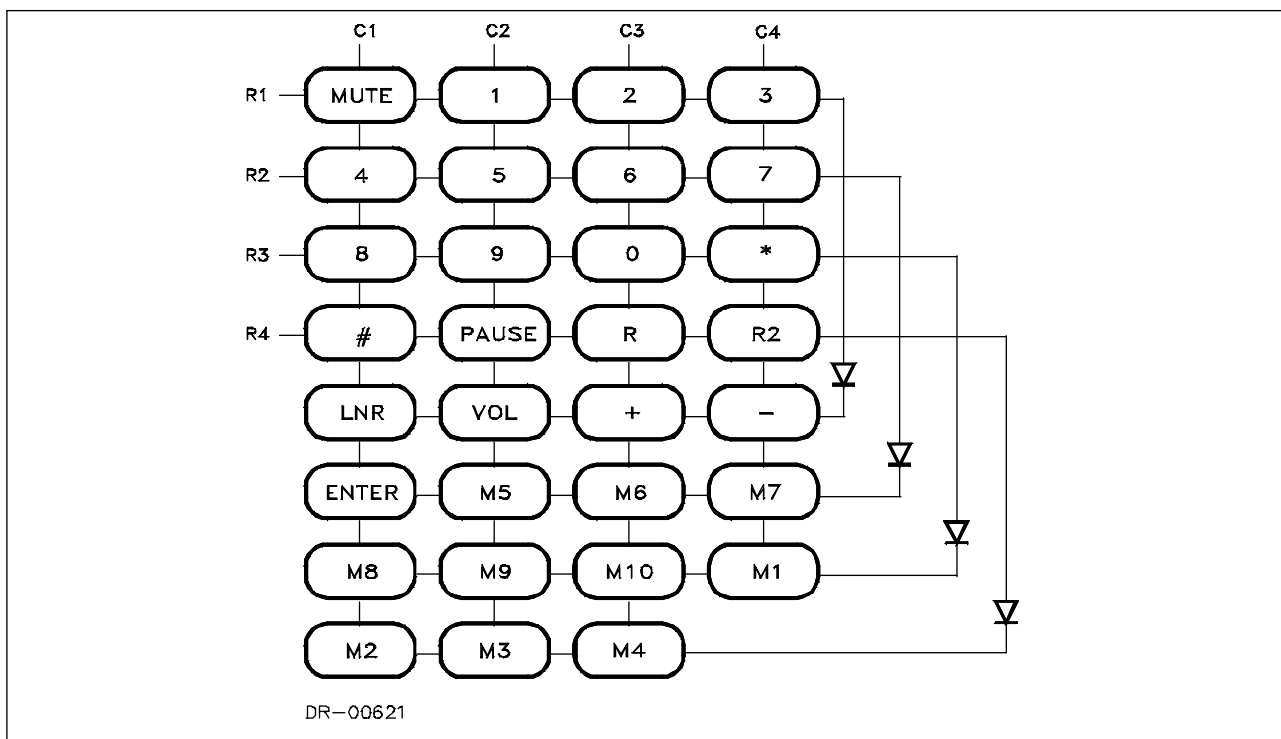
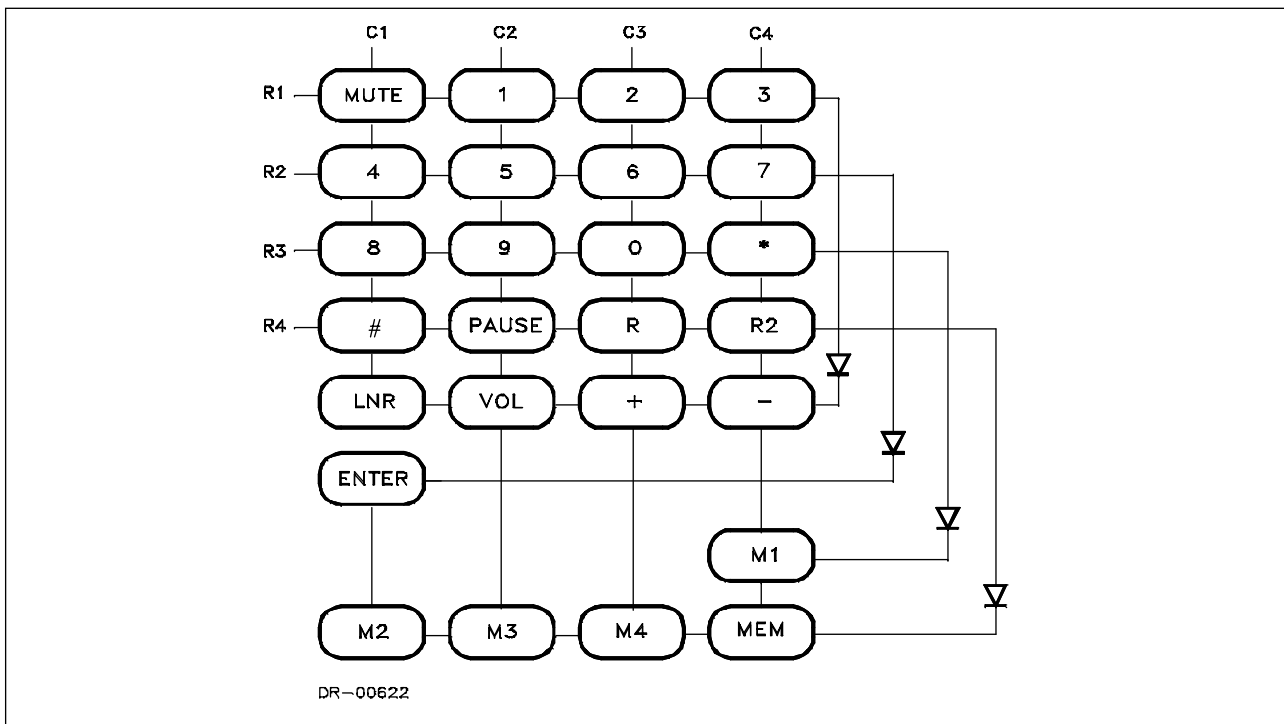

**Figure 2**



**KEYBOARD ARRANGEMENT 2**

4 Direct and 10 Indirect memories  
(either **VOL** or **+/-** keys)

**Figure 3****Tone Ringer**

The Tone Ringer of the SA2531 incorporates a Discriminator Circuit and adjustable Melody Generator

**Ring Frequency Discrimination**

The Ring Frequency Discriminator assures that only signals with a frequency between 20Hz and 60Hz (option 13 Hz to 70 Hz) are regarded as valid ring signals.

When a valid ring signal is present for 73 ms continuously, the melody generator is activated and remains active as long as the ring signal is present.

Once the melody generator has been started, the ring signal is continuously monitored and the melody generator is instantly turned on or off according to the momentary presence of a valid or invalid ring signal respectively (until next POR or off-hook).

**Melody Generator**

When a Valid Ring Signal is detected the Melody generator is activated and creates a ringing Signal comprising 3 frequencies F1 (800Hz), F2 (1067Hz) and F3 (1333Hz).

These frequencies are repeated in a sequence of 6 time slots constructed by the frequencies

F1 F2 F3 F1 F2 F3

This sequence is repeated 1, 4, 7 or 10 times per second as indicated by the connection of the RR Pin to one of the four rows of the keyboard.

TYPICAL APPLICATION

Only the components necessary for presenting the complete functions of the SA2531 are included.

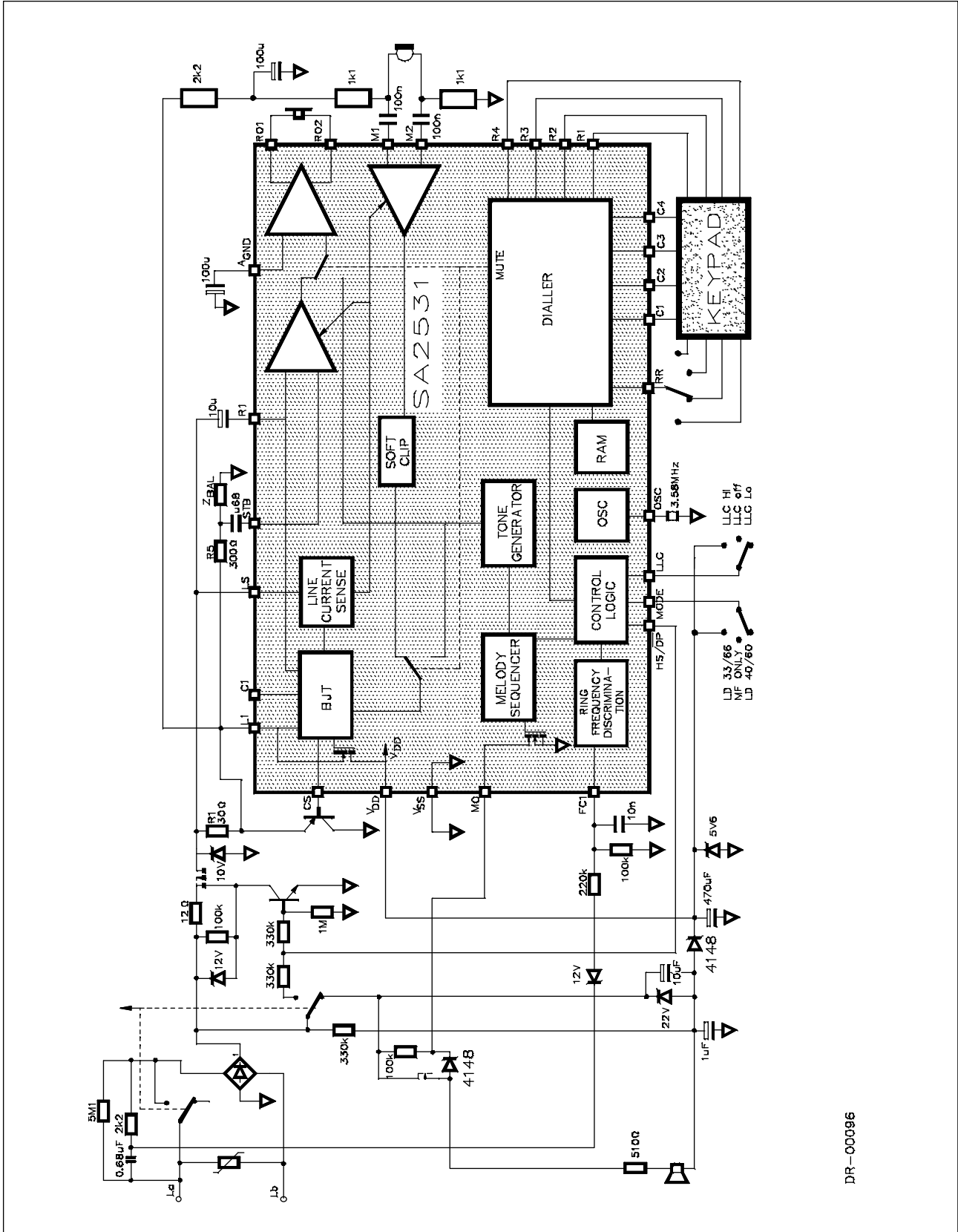

DR-00096

Digit 2-5-8-0	1336 Hz	(Error = +.176%)
Digit 3-6-9-#	1477Hz	(Error = -.141%)

Errors are calculated with reference to a base clock of 3.58MHz and at ambient temperature of 24°C. They exclude tolerance errors in the base frequency.











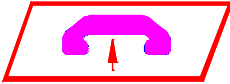

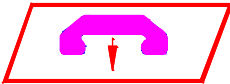
## OPERATING PROCEDURES

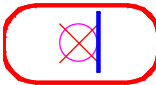
### Procedure Principles

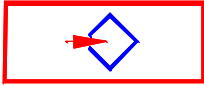
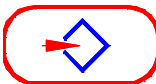
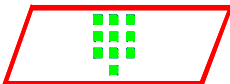
The procedures for utilizing the features of the SA2531 are optimized out of consideration for the human factor in order to:

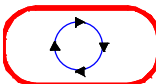
- meet the user's expectations
- be easy to learn and relearn

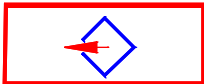
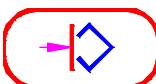
### SYMBOLS

<u>STATES</u>	<u>ENTRIES</u>	<u>PROCESSING</u>
 IDLE (ON HOOK, NO RINGING)	 GOING OFF-HOOK	 TIME OUT (x sec.)
 SPEECH MODE	 GOING ON-HOOK	 DIALLING (LD OR MF)
 PRIVACY MUTE	 PRESSING A KEY	 STORING (WRITING INTO RAM)
 PROGRAMMING	 ENTERING A NUMBER	 PROCESSING ACCORDING TO TEXT
 FALSE PROGRAMME ENTRY	 ENTRY ACCORDING TO TEXT	 READING FROM MEMORY
 INVALID ENTRY		
 STATE ACCORDING TO TEXT		

DR-00623

### Privacy Mute

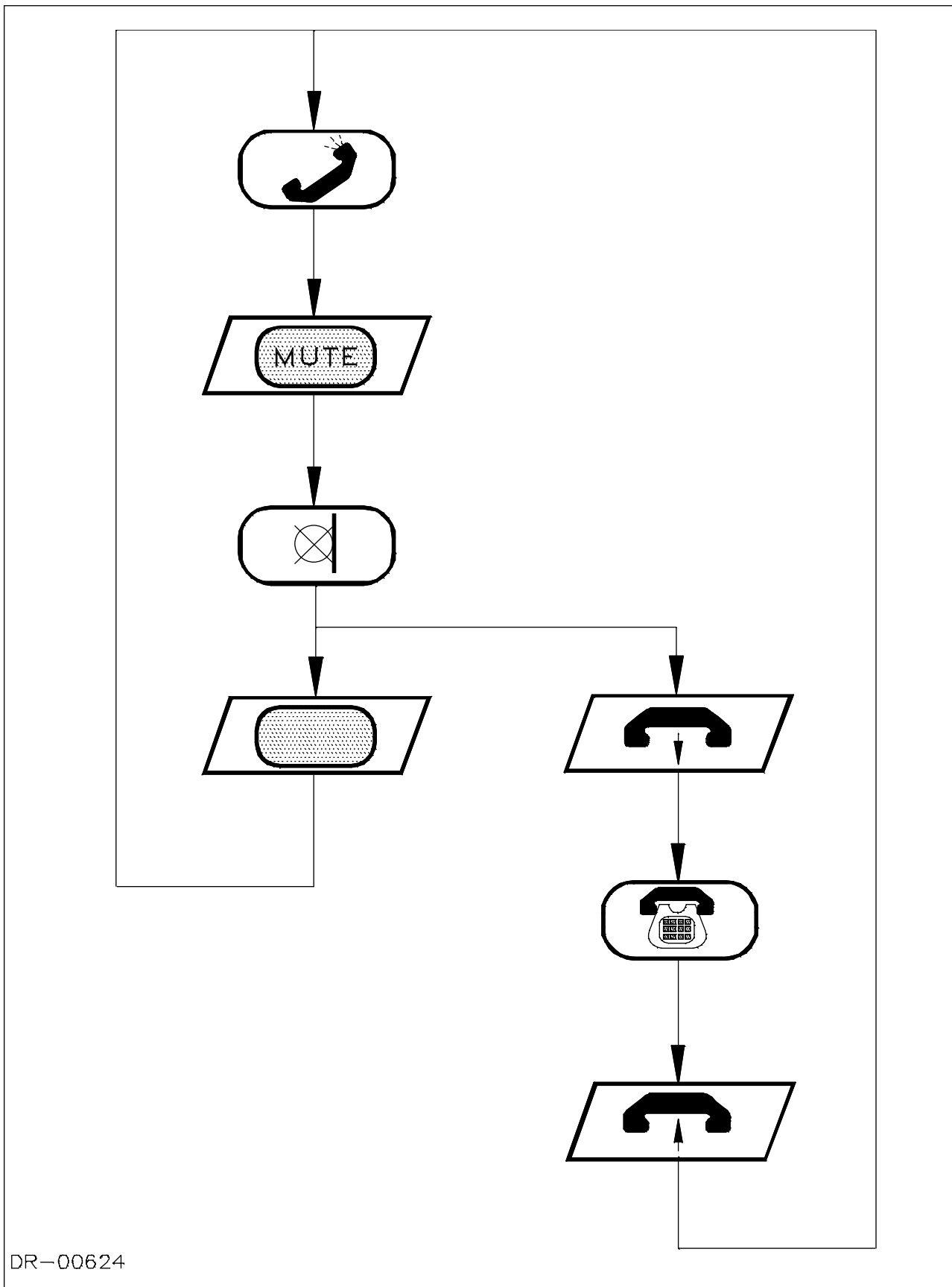

DR-00624

Temporary MF

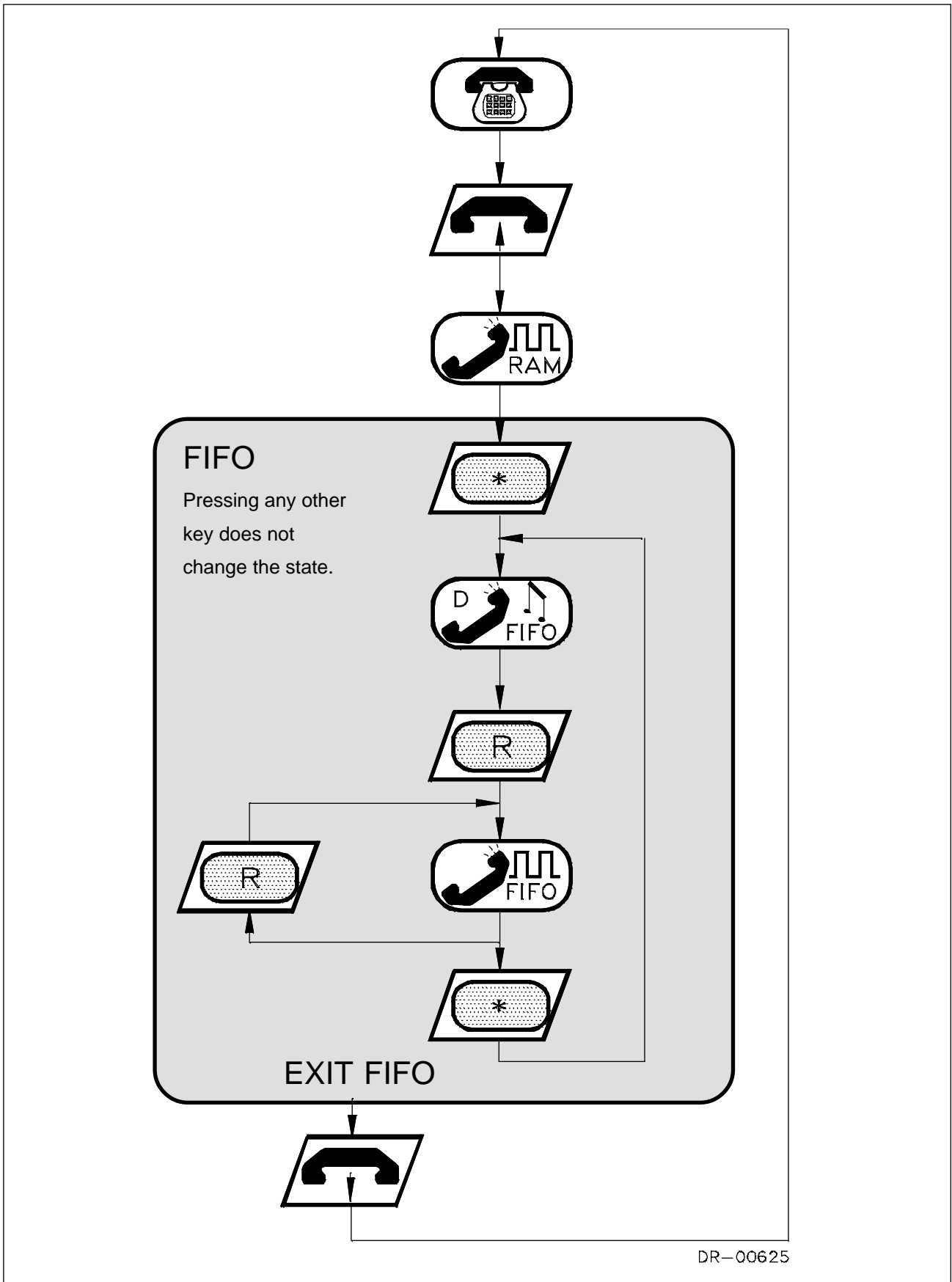

DR-00625

### Storing Numbers

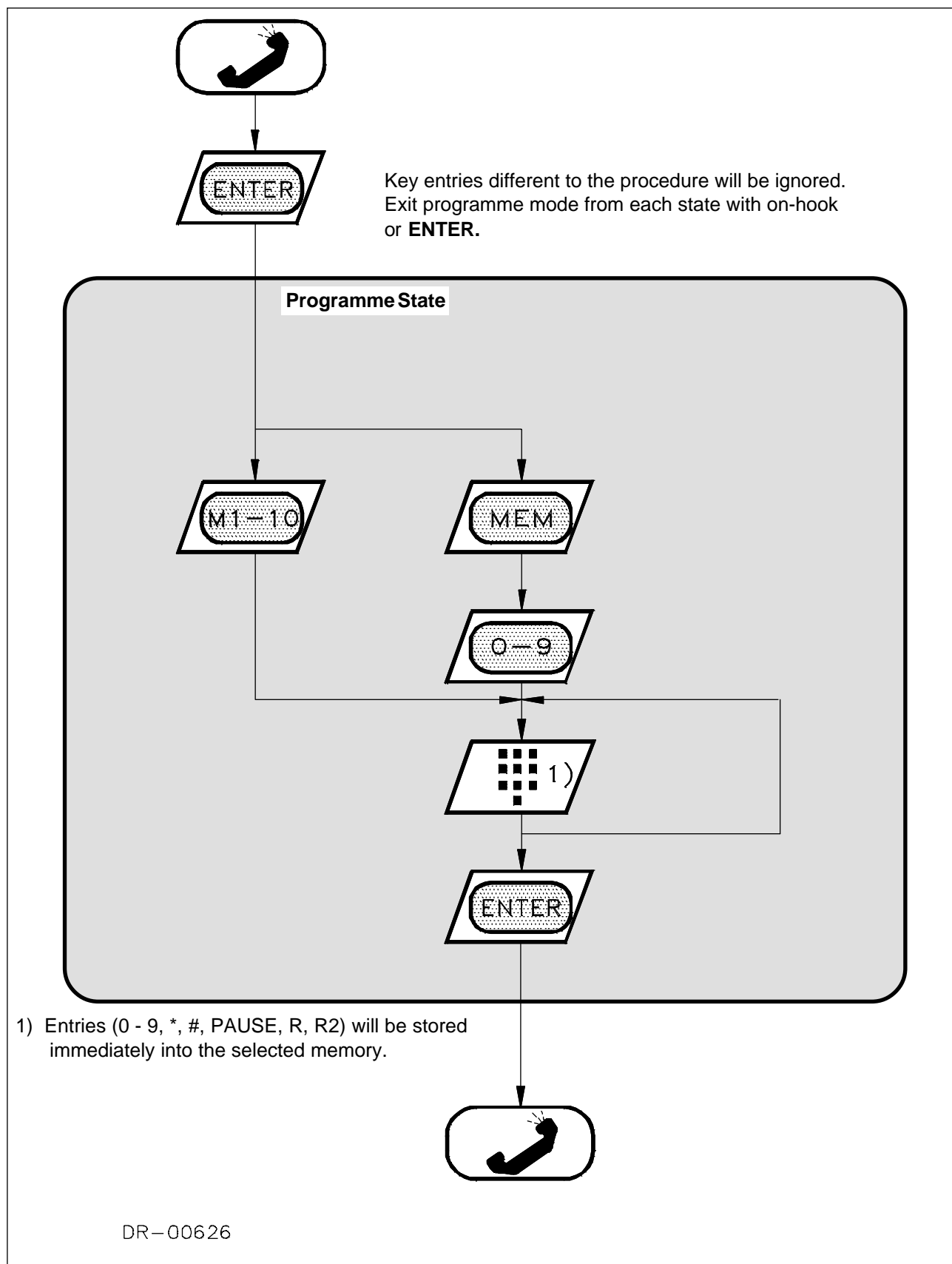

DR-00626

## Automatic Dialling

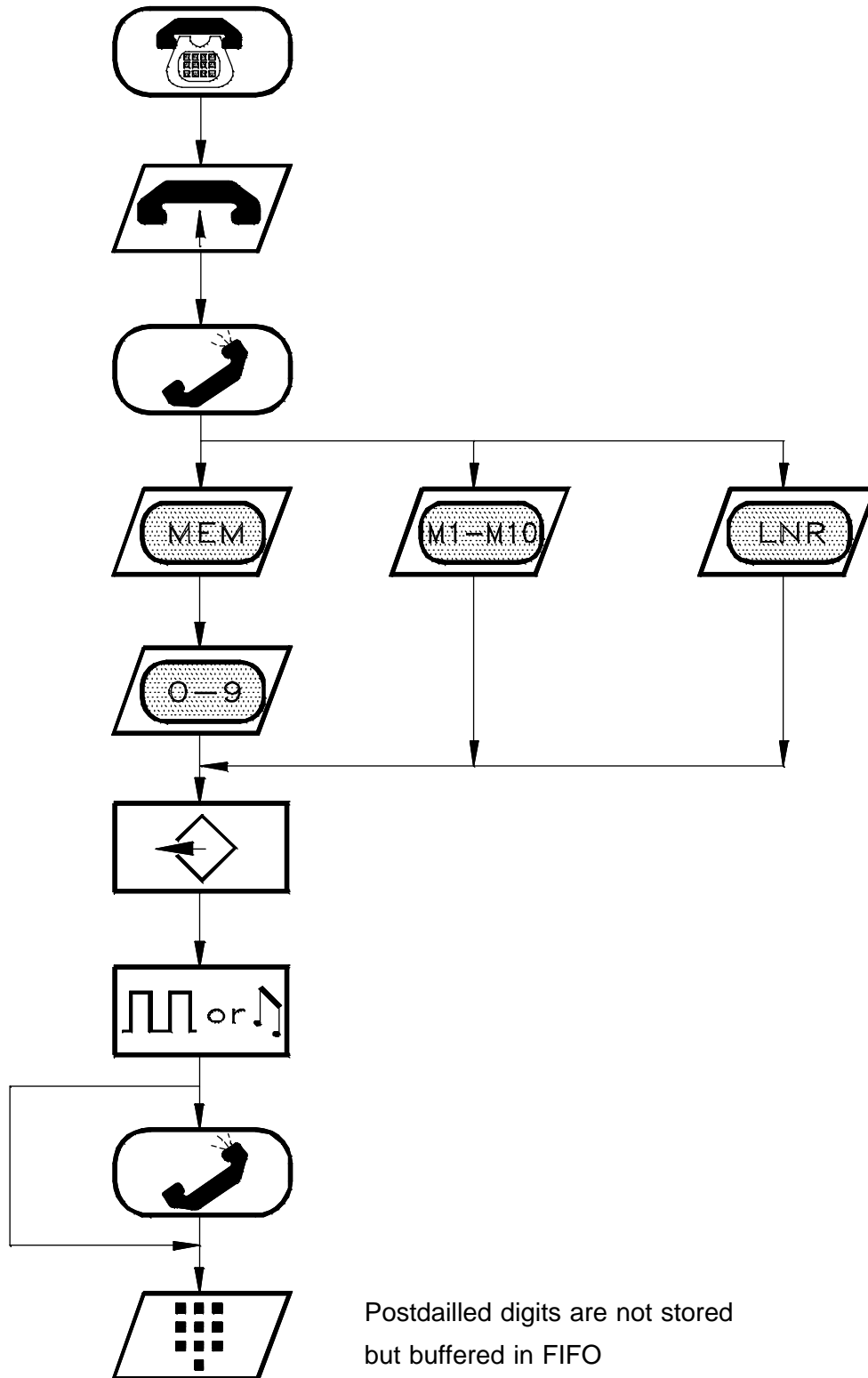

DR-00627

TIMING DIAGRAMS

LD Dialling

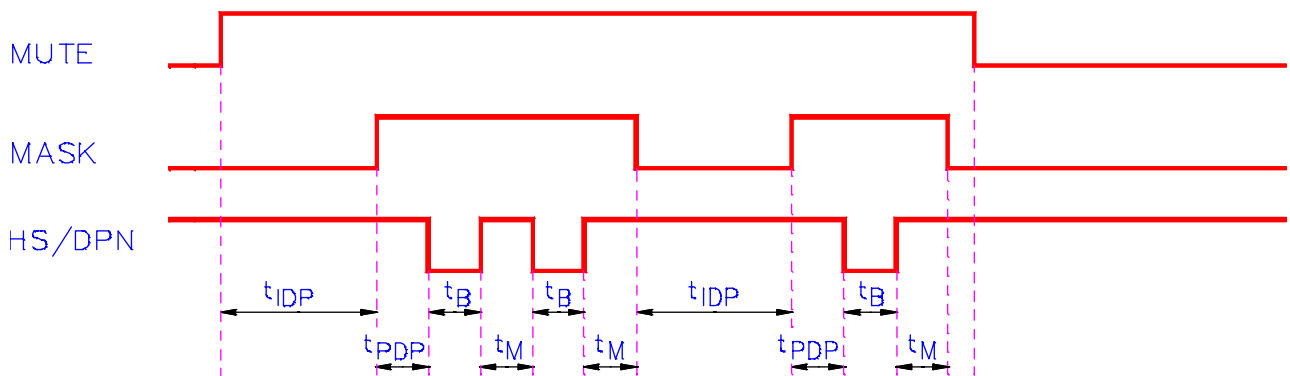

LD Dialling with Access Pause

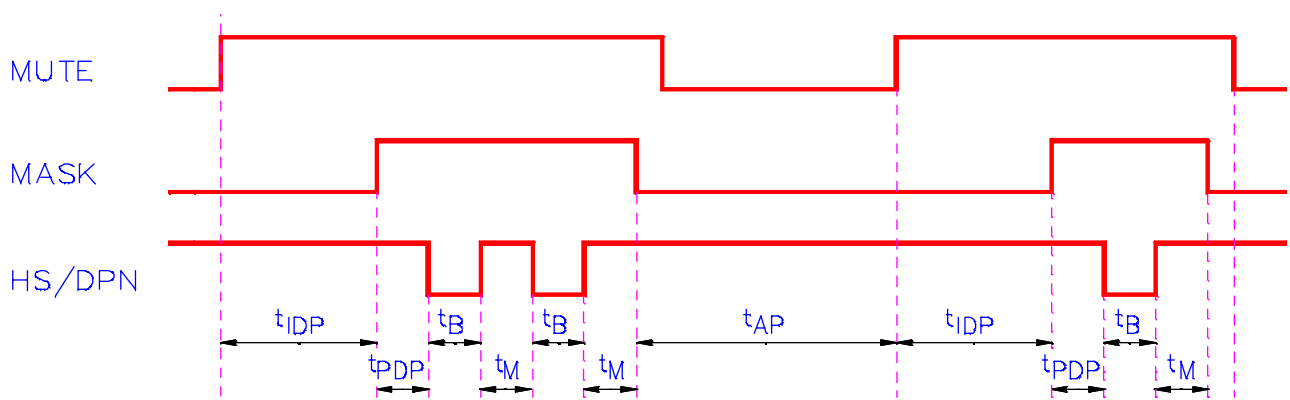

MF Dialling

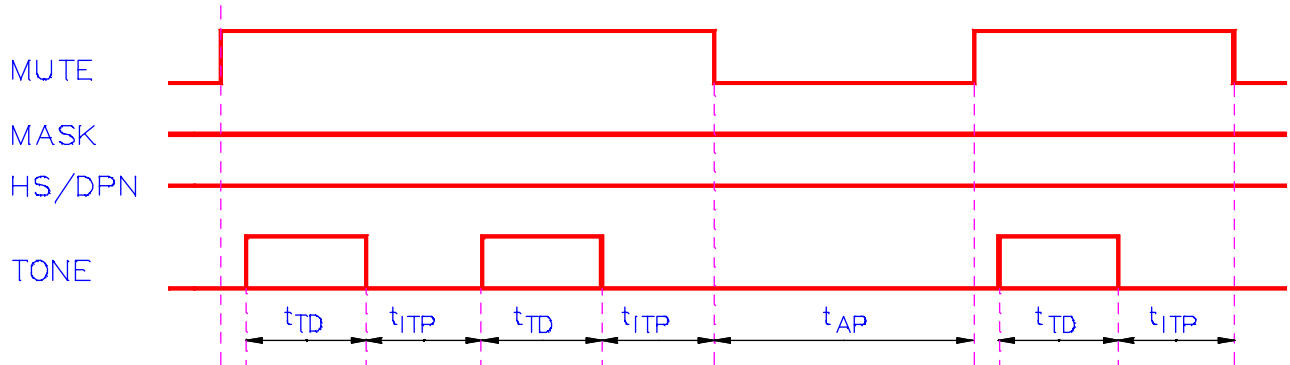

DR-00097



**Flash**

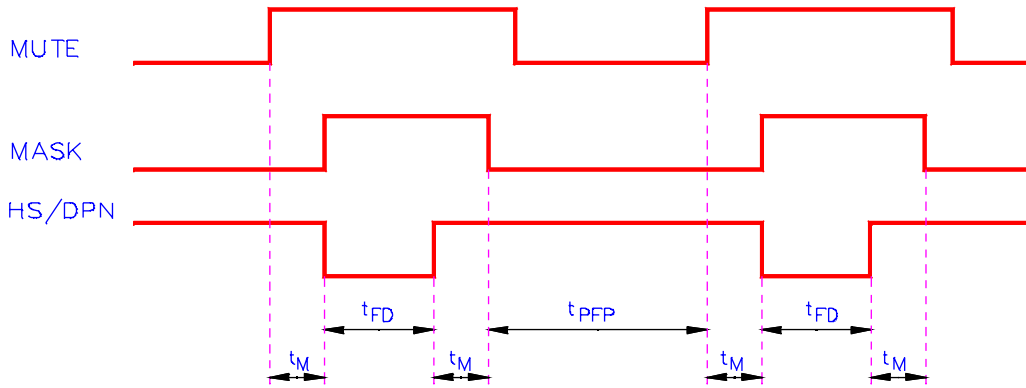

DR-00098

**ELECTRICAL CHARACTERISTICS**

**Absolute Maximum Ratings**

Positive Supply Voltage	$-0.3V \leq V_{DD} \leq 7V$
Input current	$\pm 25mA$
Input Voltage (LS)	$-0.3V \leq V_{IN} \leq 10V$
Input Voltage (LI, CS)	$-0.3V \leq V_{IN} \leq 8V$
Input Voltage (STB, RI)	$-2V \leq V_{VIN} \leq V_{DD} + 0.3V$
Input Voltage (MO)	$-0.3V \leq V_{IN} \leq 35V$
Digital Input Voltage	$-0.3V \leq V_{IN} \leq V_{DD} + 0.3V$
Electrostatic Discharge	$\pm 800V$
Storage Temperature	$-65^\circ C$ to $+125^\circ C$

**Recommended Operating Conditions**

Supply Voltage * (Speech Mode)	$4V \leq V_{DD} \leq 5V$
Oscillator Frequency (Resonator: Murata CSA 3.58M G312AM)	3.58 MHz
Operating Temperature	$-25^\circ C$ to $+70^\circ C$

\* This voltage is generated internally

**DC Characteristics ( $I_{LINE} = 15\text{ mA}$  unless otherwise specified)**

Symbol	Parameter	Conditions	Min	Typ	Max	Units
$I_{DD}$	Operating Current	Speech mode		3	5	mA
		MF dialling		4		mA
		LD dialling $V_{DD} = 2.5V$		200		$\mu A$
		Ring mode $V_{DD} = 2.5V$		300		$\mu A$
$I_{DDO}$	Retention Current	Idle mode $V_{DD} = 2V$ , $T_{AMB} = 25^\circ C$		0.05		$\mu A$
$V_{LI}$	Line Voltage (default)	$13mA \leq I_{LINE} \leq 100mA$		4.5		V
$I_{OL}$	Output Current, Sink CS, HS/DP, MO	$V_{OL} = 0.4V$		1.5		mA

**AC Characteristics ( $I_{LINE}=15mA;f=800Hz$  unless otherwise specified)**

Symbol	Parameter	Conditions	Min	Typ	Max	Units
<b>TX</b>	<b>Transmit</b>	<b>Test Circuit Fig.5</b>				
$A_{TX}$	Gain (M1/M2)	$Z_{RL}=600\Omega$ (A/B/E/F/J) $Z_{RL} = 1000\Omega$ (C/D/G/v)	34	35 36.5	36	dB
$\Delta A_{TX/F}$	Variation with Frequency	$f=500Hz$ to 3.4kHz		$\pm 0.8$		dB
THD	Distortion	$V_{LI} \leq 0.5V_{RMS}$			2	%
$V_{AGC}$	Soft Clip Level	$V_{LI} =$		2		$V_{PEAK}$
$A_{SCO}$	Soft Clip Overdrive			20		dB
$t_{ATTACK}$	Attack Time			30		$\mu s/6dB$
$t_{DECAY}$	Decay Time			20		ms/6dB
$Z_{IN}$	Input Impedance (M1/M2)			20		k $\Omega$
$A_{MUTE}$	Mute Attenuation	Mute activated	60			dB
$V_{NO}$	Noise Output Voltage				-72	dBmp
$V_{FC}$	Unwanted Frequency Components	50...300 Hz 4.3...28 kHz above 28 kHz			-43 note 6 -70	dBm  dBm
$V_{INMAX}$	Input Voltage Range (M1/M2)	Differential Single Ended		$\pm 1$ $\pm 0.5$		$V_{PEAK}$ $V_{PEAK}$
<b>BJT</b>	<b>Output Driver</b>					
$V_{INMAX}$	Input Voltage Range (LI)			$\pm 2$		$V_{PEAK}$
$V_{TX}$	Dynamic Range			$\pm 2$		$V_{PEAK}$
RL	Return Loss	$Z_{RL} = 600\Omega$ and 1000 $\Omega$	18			dB

AC Characteristics (cont'd) ( $I_{LINE} = 15 \text{ mA}; f=800\text{Hz}$  unless otherwise specified)

Symbol	Parameter	Conditions	Min	Typ	Max	Units
<b>RX</b>	<b>Receive</b>	<b>Test Circuit Fig.5</b>				
$A_{RX}$	Receive Gain (RO1/RO2)	$Z_{RL}=600\Omega$ (A/B/E/F/J) $Z_{RL}=1000\Omega$ (C/G/U) (D)	1	2 0 6	3	dB
$\Delta A_{RX/F}$	Variation with Frequency	$f=500 \text{ Hz to } 3.4 \text{ kHz}$		$\pm 0.8$		dB
<b>THD</b>	Distortion	$V_{RI} \leq 0.5 V_{RMS}$			2	%
$V_{AGC}$	SoftClipLevel	$V_{RI} =$		1		$V_{PEAK}$
$A_{SCO}$	Soft Clip Overdrive			10		dB
$t_{ATTACT}$ 6dB	Attact Time	$V_{RI} > 0.8V$			0	$\mu s/$
$t_{DECAY}$	Decay Time			20		ms/6dB
$V_{NO}$	Noise Output Voltage				-72	dBmp
$V_{FC}$	Unwanted Frequency	50 Hz...20 kHz			-60	dBm
	Components					
$Z_{IN}$	Input Impedance (RI)			8		$k\Omega$
$V_{IN\_RI}$	Input Voltage Range (RI)			$\pm 2$		$V_{PEAK}$
<b>ST</b>	<b>Sidetone</b>	<b>Test Circuit Fig.5</b>				
$A_{ST}$	Sidetone Cancellation	$V_{RI} \leq 0.5 V_{RMS}$	0			dB
$V_{IN\_ST}$	Input Voltage Range (STB)			$\pm 2$		$V_{PEAK}$
$Z_{IN}$	Input Impedance (STB)			80		$k\Omega$
	<b>Keyboard</b>					
$t_D$	Key Debounce Time			15		ms
	<b>HS Input</b>					
$t_{HS-L}$	Low to High Debounce	Going off-hook		15		ms
$t_{HS-H}$	High to Low Debounce	Line breaks/on-hook		240		ms
	<b>DTMF</b>					
$\Delta F$	Frequency deviation	Note5			1.2	%
$V_{MF}$	MF Tone Level (Low group)	SA2531B/D/G/U	-12.5	-11	-9.5	dB
		SA2531A/C/E/F/J	-9.5	8	-6.5	dB
$V_{L-H}$	Preemphasis Low to High	SA2531A/B/C/E/F/J/U	2.0	0	3.0	dB
$V_{L-H}$	Preemphasis Low to High	SA2531D/G	2.0	2.6	3.2	dB

## AC Characteristics Cont'd

Symbol	Parameter	Conditions	Min	Typ	Max	Units
$t_{TD}$	Tone Duration	Note 1	80	82.3	85	ms
$t_{ITP}$	Inter Tone Pause	SA2531A/B/C/D/F/ G/J/U Note 1	80	82.3	85	ms
$t_{ITP}$	Inter Tone Pause	SA2531E; Note 1	160	165	170	ms
$t_{TR}$	Tone Rise Time	Note 2			5	ms
$t_{TF}$	Tone Fall Time	Note 2			5	ms
	<b>LD</b>					
$t_{DR}$	Dial Rate	$\pm 5\%$		10		pps
$t_{MB}$	Make/Break Period	$\pm 5\%$ , MODE=low $\pm 5\%$ , MODE=high		40.8/61.2 33/66		ms ms
$t_{PDP}$	Pre-Digit Pause			35		ms
$t_{IDP}$	Inter Digit Pause		800	840	880	ms
$t_{MO}$	Mute Overhang			$t_M$		
$t_{FD}$	Flash Duration 1		100		102	ms
	Flash Duration 2	SA2531B/CD//E/F/G	270		300	ms
	Flash Duration 2	SA2531A/J/U	600		650	ms
$t_{PFP}$	Post Flash Pause	SA2531 A/B/F		2.74		ms
		SA2531 C/D/E/G/J/U	2.9	3.0	3.1	sec.
$t_{AP}$	Access Pause	SA2531A/B/F	2.0	2.05	2.12	sec
$t_{AP}$	Access Pause	SA2531C	5.8	6.0	6.2	sec
		SA2531D/E/G/J/U	2.9	3.0	3.1	sec
	<b>Tone Ringer</b>					
$V_{MO}$	Melody Output Level			PDM		
$t_{MD}$	Melody Delay				10	ms
F1	Frequency 1		770	800	830	Hz
F2	Frequency 2		1025	1067	1110	Hz
F3	Frequency 3		1280	1333	1385	Hz
$t_{DT}$	Detection Time	Initial	70		80	ms
$t_{TO}$	Detection Time-out			note 4		ms
$f_{MIN}$	Min. Detection Frequency	SA2531D/G	19	20	21	Hz
$f_{MIN}$	Min. Detection Frequency	SA2531A/B/C/E/F/J/U	12	13	14	Hz
$f_{MAX}$	Max. Detection Frequency	SA2531D/G	58	59	60	Hz
	Max. Detection Frequency	SA2531A/B/C/E/F/J/U	68	70	75	Hz

**AC Characteristics Cont'd**

Symbol	Parameter	Conditions	Min	Typ	Max	Units
$V_{RT}$	Reminder Tone Level (RO1/RO2)	Relative to LS		-30		dBr
$t_{RTD}$	Duration			82.3		ms
$t_{RTI}$	Interval			3		sec
$V_{CT}$	Comfort Tone (DTMF) Level (RO1/RO2)	Relative to LS		-30		dBr

Note 1: The values are valid during automatic dialling and are minimum values during manual dialling, i.e. the tones will continue as long as the key is depressed.

Note 2: The rise time is the time from 10% of final value till the tone amplitude has reached 90% of its final value.

Note 3: Relative to high group.

Note 4: The FCI circuit is reset by POR and HS/DP pulled high (off-hook). After a reset the FCI circuit is in a standby state. A positive edge on FCI will start a 73 ms timer and the frequency discrimination is initiated. Whenever a period of the ring signal is missing, the timer is reset. When a valid ring signal is present for  $\geq 73$  ms, the melody generator is started and is directly controlled by the ring signal. This condition will remain until a new reset.

Note 5: This does not include the frequency deviation of the ceramic resonator.

Note 6: -37 dBm at 4.3 kHz and decreasing 12 dB/octave till 28 kHz.

**Ordering information:**

Versions	ZRL (W)	DTMF Level	FCI (Hz)	ITP (ms)	R2 (ms)	Flash in LD Mode	Flash Pause	Access Pause	Remarks
SA2531A	600	-6/-8dBm	13-70	82	600	yes	274ms	2 sec	
SA2531B	600	-9/-11dBm	13-70	82	280	yes	274ms	2 sec	
SA2531C	1000	-6/-8dBm	13-70	82	280	no	3 sec	6 sec	
SA2531D	1000	-9/-11dBm	20-60	82	280	no	3 sec	3 sec	Rx gain + 6dB, no VOL
SA2531E	600	-6/-8dBm	13-70	165	280	no	3 sec	3 sec	
SA2531F	600	-6/-8dBm	13-70	82	280	yes	274 ms	2 sec	MF select (*) with tone
SA2531G	1000	-9/-11dBm	20-60	82	280	no	3 sec	3 sec	
SA2531J	600	-6/-8dBm	13-70	82	600	yes	3 sec	3 sec	Mode pin: 10/20 pps
SA2531U	1000	-9/-11dBm	13-70	82	600	yes	3 sec	3 sec	

Package styles:           DIP "P"                   SOIC "S"                   PLCC "F"

Example:           SA2531U in PLCC Package = SA2531UAFA

**Application support:**

For application support, contact your nearest SAMES Sales Office.

Test Circuit

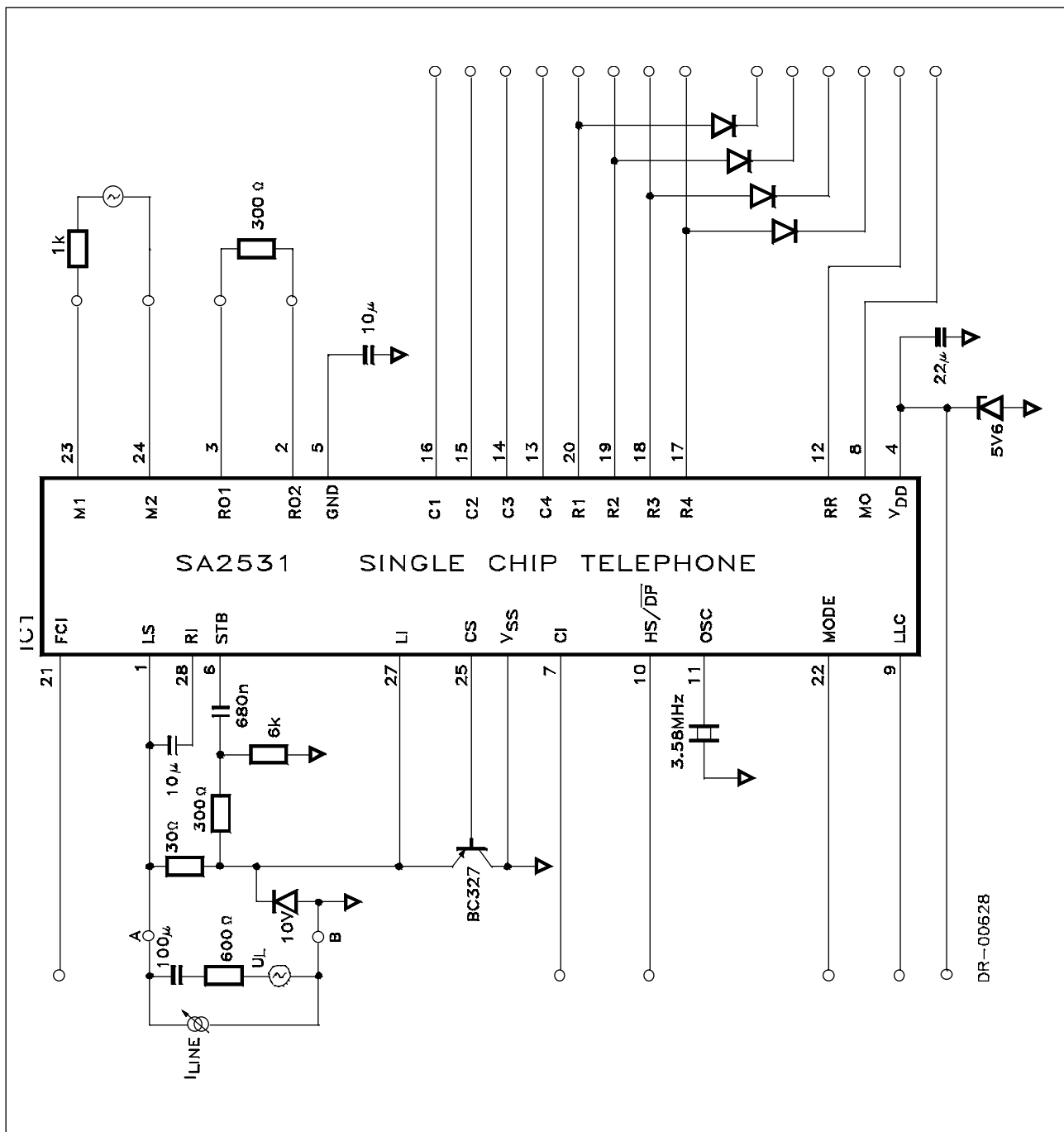

Figure 5

NOTES:

**Disclaimer:** The information contained in this document is confidential and proprietary to South African Micro-Electronic Systems (Pty) Ltd ("SAMES") and may not be copied or disclosed to a third party, in whole or in part, without the express written consent of SAMES. The information contained herein is current as of the date of publication; however, delivery of this document shall not under any circumstances create any implication that the information contained herein is correct as of any time subsequent to such date. SAMES does not undertake to inform any recipient of this document of any changes in the information contained herein, and SAMES expressly reserves the right to make changes in such information, without notification, even if such changes would render information contained herein inaccurate or incomplete. SAMES makes no representation or warranty that any circuit designed by reference to the information contained herein, will function without errors and as intended by the designer.

**South African Micro-Electronic Systems (Pty) Ltd**

P O Box 15888,	33 Eland Street,
Lynn East,	Koedoespoort Industrial Area,
0039	Pretoria,
Republic of South Africa,	Republic of South Africa

Tel: 012 333-6021

Tel: Int +27 12 333-6021

Fax: 012 333-8071

Fax: Int +27 12 333-8071