

# DATA SHEET

## **SAA7206H** DVB compliant descrambler

Product specification  
Supersedes data of 1996 Oct 02  
File under Integrated Circuits, IC02

1996 Oct 09

---

**DVB compliant descrambler****SAA7206H**

---

**CONTENTS**

1	FEATURES
2	GENERAL DESCRIPTION
3	ORDERING INFORMATION
4	QUICK REFERENCE DATA
5	BLOCK DIAGRAM
6	PINNING
7	FUNCTIONAL DESCRIPTION
7.1	MPEG-2 systems parsing
7.2	PES level descrambling
7.3	Descrambler core
7.4	Microcontroller interface
7.5	Output interfacing
7.6	Boundary scan test
7.7	Programming the descrambler
8	LIMITING VALUES
9	HANDLING
10	THERMAL CHARACTERISTICS
11	DC CHARACTERISTICS
12	AC CHARACTERISTICS
13	PACKAGE OUTLINE
14	SOLDERING
14.1	Introduction
14.2	Reflow soldering
14.3	Wave soldering
14.3.1	QFP
14.3.2	SO
14.3.3	Method (QFP and SO)
14.4	Repairing soldered joints
15	DEFINITIONS
16	LIFE SUPPORT APPLICATIONS

## DVB compliant descrambler

## SAA7206H

**1 FEATURES**

- Input data fully compliant with the Transport Stream (TS) definition of the MPEG-2 systems specification
  - Input data signals; [Forward Error Correction (FEC) Interface]
    - modem data input bus (8-bit wide)
    - valid input data indicator
    - erroneous packet indicator
    - first packet byte indicator
    - byte strobe signal (for asynchronous mode only).
- The interface can be programmed to one of two modes:
- Asynchronous mode; byte strobe input signal (MBCLK) < 9 MHz, for connection to a modem (FEC)
  - Synchronous mode; MBCLK is not used. Data is delivered to the descrambler synchronized with the chip clock (DCLK) [9 MHz (typ.) with a 33% duty cycle].
- No external memory
  - Effective bit rate;  $f_{bit} \leq 72$  MHz
  - Control interface; 8-bit multiplexed data/address, memory mapped I/O (90CE201 microcontroller parallel bus compatible), in combination with a microcontroller interrupt signal (IRQ)
  - Output ports are identical to the input data interface (demultiplexer interface)
    - except for the packet error indicator ( $\overline{MB}/MB$ ), as the descrambler translates an active MB signal to the 'transport\_error\_indicator' bit in the transport stream
    - except for the byte strobe input signal (MBCLK), as data is delivered to the demultiplexer, synchronized with the descrambler chip clock which is generated by the demultiplexer

- Descrambler, based on the super descrambler mechanism algorithm with stream decipher and block decipher. The descrambler is initialized with a 64-bit Control Word (CW) at the beginning of a transport stream packet payload of a selected Packet Identification (PID). The descrambler operates on transport stream packet or Packetized Elementary Stream (PES) packet payloads
- Microcontroller support; only for control, no specific descrambling tasks are performed by the microcontroller. However, parsing and processing of conditional access information (such as EMM and ECM data) is left to the system microcontroller
- Boundary scan test port for boundary scan.

**2 GENERAL DESCRIPTION**

The SAA7206H (DVB compliant) is designed for use in MPEG-2 based digital TV receivers, incorporating conditional access filters. Such receivers are to be implemented in, for instance, a digital video broadcasting top set box, or an integrated digital TV receiver. An example of a demultiplexer/descrambler system configuration, containing a channel decoder module, a demultiplexer, a system controller and a conditional access system is shown in Fig.3. The main function of the descrambler is to descramble the payloads of MPEG-2 TS packets or PES packets. In addition, the descrambler retrieves Conditional Access (CA) data [such as Entitlement Management Messages (EMM) and Entitlement Control Messages (ECM) etc.] from the stream and passes it to the system microcontroller for processing.

**3 ORDERING INFORMATION**

TYPE NUMBER	PACKAGE		
	NAME	DESCRIPTION	VERSION
SAA7206H	QFP64	plastic quad flat package; 64 leads (lead length 1.95 mm); body 14 × 20 × 2.8 mm	SOT319-2

DVB compliant descrambler

SAA7206H

4 QUICK REFERENCE DATA

SYMBOL	PARAMETER	CONDITIONS	MIN.	TYP.	MAX.	UNIT
V <sub>DDD</sub>	digital supply voltage		–	–	5.5	V
V <sub>DDD(core)</sub>	digital supply voltage for core		–	–	3.6	V
P <sub>tot</sub>	total power dissipation	V <sub>DDD(core)</sub> = 3.3 V, V <sub>DDD</sub> = 5 V, C <sub>L</sub> = 15 pF	–	–	250	mW
f <sub>clk</sub>	clock frequency	duty cycle = 30 to 55%	–	–	9	MHz
T <sub>amb</sub>	operating ambient temperature		0	–	70	°C

5 BLOCK DIAGRAM

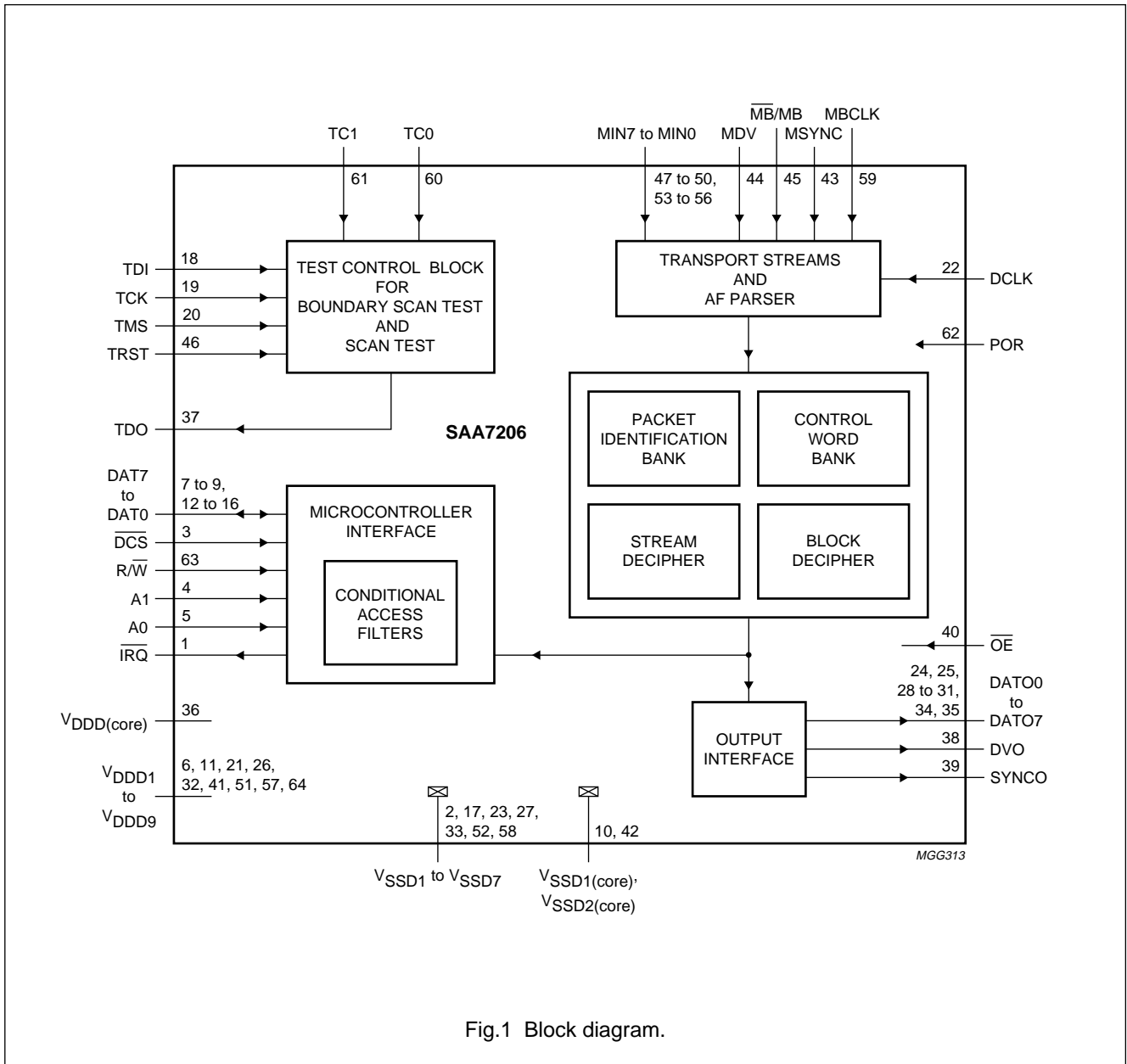

Fig.1 Block diagram.

## DVB compliant descrambler

## SAA7206H

## 6 PINNING

SYMBOL	PIN	I/O	DESCRIPTION
$\overline{\text{IRQ}}$	1	O	interrupt request output for microcontroller (active LOW, open-drain output)
$V_{\text{SSD1}}$	2	GND	digital ground 1
$\overline{\text{DCS}}$	3	I	descrambler chip select input (active LOW)
A1	4	I	A1 = address/data indicator input
A0	5	I	A0 = MSByte indicator input
$V_{\text{DDD1}}$	6	supply	digital supply voltage 1 (+5 V)
DAT7	7	I/O	microcontroller bidirectional data bus bit 7
DAT6	8	I/O	microcontroller bidirectional data bus bit 6
DAT5	9	I/O	microcontroller bidirectional data bus bit 5
$V_{\text{SSD1(core)}}$	10	GND	digital ground 1 for core
$V_{\text{DDD2}}$	11	supply	digital supply voltage 2 (+5 V)
DAT4	12	I/O	microcontroller bidirectional data bus bit 4
DAT3	13	I/O	microcontroller bidirectional data bus bit 3
DAT2	14	I/O	microcontroller bidirectional data bus bit 2
DAT1	15	I/O	microcontroller bidirectional data bus bit 1
DAT0	16	I/O	microcontroller bidirectional data bus bit 0
$V_{\text{SSD2}}$	17	GND	digital ground 2
TDI	18	I	boundary scan test data input
TCK	19	I	boundary scan test clock input
TMS	20	I	boundary scan test mode select input
$V_{\text{DDD3}}$	21	supply	digital supply voltage 3 (+5 V)
DCLK	22	I	9 MHz descrambler chip clock input (duty cycle range: 30 to 55%)
$V_{\text{SSD3}}$	23	GND	digital ground 3
DAT00	24	O	data output to demultiplexer bit 0
DAT01	25	O	data output to demultiplexer bit 1
$V_{\text{DDD4}}$	26	supply	digital supply voltage 4 (+5 V)
$V_{\text{SSD4}}$	27	GND	digital ground 4
DAT02	28	O	data output to demultiplexer bit 2
DAT03	29	O	data output to demultiplexer bit 3
DAT04	30	O	data output to demultiplexer bit 4
DAT05	31	O	data output to demultiplexer bit 5
$V_{\text{DDD5}}$	32	supply	digital supply voltage 5 (+5 V)
$V_{\text{SSD5}}$	33	GND	digital ground 5
DAT06	34	O	data output to demultiplexer bit 6
DAT07	35	O	data output to demultiplexer bit 7
$V_{\text{DDD(core)}}$	36	supply	digital supply voltage for core (+3.3 V)
TDO	37	O	boundary scan test data output
DVO	38	O	valid output data indicator
SYNCO	39	O	indicates the first output byte (sync) of a transport packet

## DVB compliant descrambler

## SAA7206H

SYMBOL	PIN	I/O	DESCRIPTION
$\overline{OE}$	40	I	output enable (active LOW), if HIGH, device outputs are high impedance, (connected to logic 0 in normal operation)
$V_{DD6}$	41	supply	digital supply voltage 6 (+5 V)
$V_{SS2(core)}$	42	GND	digital ground 2 for core
MSYNC	43	I	indicates the first input byte (sync) of a transport packet
MDV	44	I	valid input data indicator
$\overline{MB}/MB$	45	I	packet error indicator input (programmable polarity)
TRST	46	I	boundary scan reset input (LOW in normal operation)
MIN7	47	I	8-bit wide modem data input bit 7
MIN6	48	I	8-bit wide modem data input bit 6
MIN5	49	I	8-bit wide modem data input bit 5
MIN4	50	I	8-bit wide modem data input bit 4
$V_{DD7}$	51	supply	digital supply voltage 7 (+5 V)
$V_{SS6}$	52	GND	digital ground 6
MIN3	53	I	8-bit wide modem data input bit 3
MIN2	54	I	8-bit wide modem data input bit 2
MIN1	55	I	8-bit wide modem data input bit 1
MIN0	56	I	8-bit wide modem data input bit 0
$V_{DD8}$	57	supply	digital supply voltage 8 (+5 V)
$V_{SS7}$	58	GND	digital ground 7
MBCLK	59	I	byte strobe input signal < 9 MHz
TC0	60	I	test control input 0 (not connected in normal operation)
TC1	61	I	test control input 1 (not connected in normal operation)
POR	62	I	power-on reset, must be active HIGH during at least 5 DCLK pulses
$R/\overline{W}$	63	I	read/write input selection
$V_{DD9}$	64	supply	digital supply voltage 9 (+5 V)

DVB compliant descrambler

SAA7206H

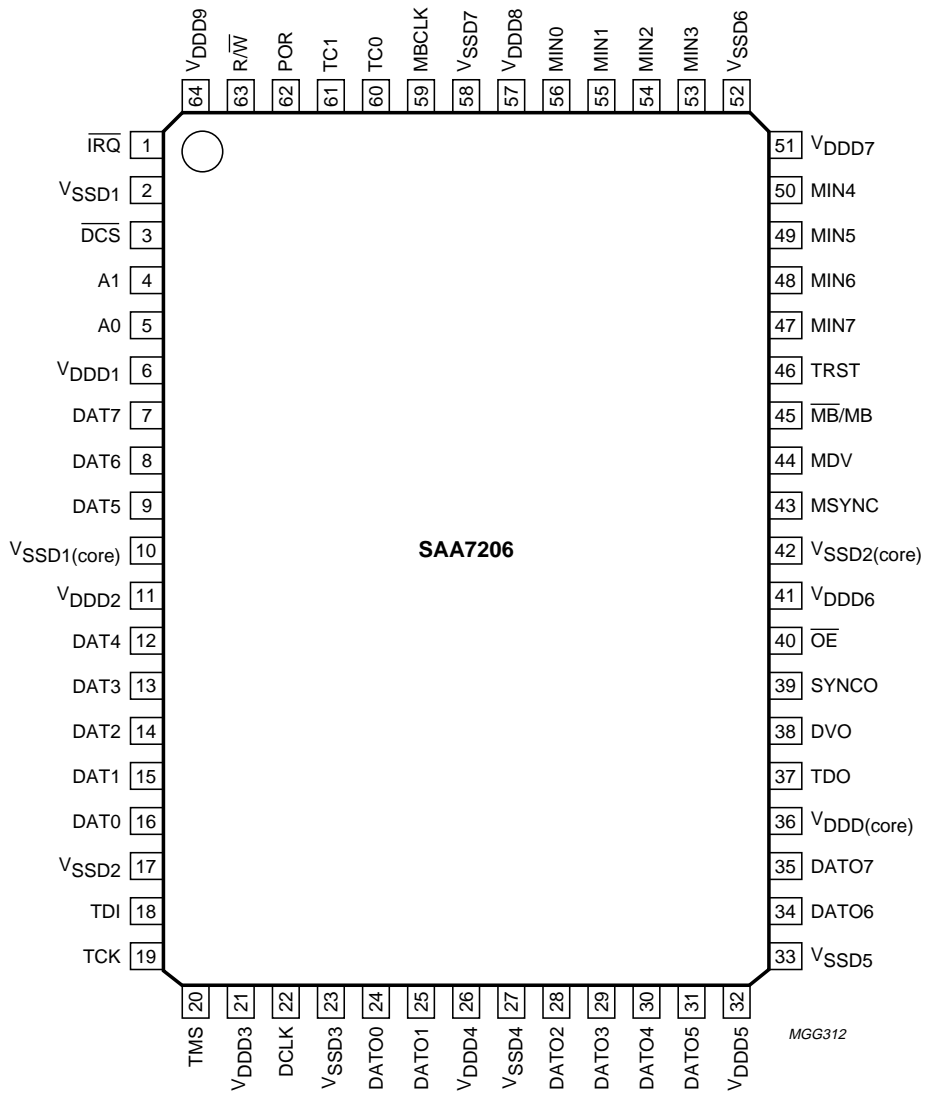

Fig.2 Pin configuration.

# DVB compliant descrambler

# SAA7206H

## 7 FUNCTIONAL DESCRIPTION

A block diagram of the internal structure of the descrambler (DVB compliant) is illustrated in Fig.1. The block diagram illustrates the main functional modules in the descrambler. The modules are as follows:

- The MPEG-2 syntax parser, which parses transport streams that comply with the MPEG-2 systems specification
- The descrambler module consisting of:
  - A Packet Identification (PID) bank containing 6 PID values of the streams selected for descrambling. All bits of PID5 (address 0x0205) can be masked individually with PID5\_mask (address 0x0209), to enable multiple PID selection.
  - A Control Word (CW) bank containing 6 CW pairs and a default CW. A CW pair consists of 2 descrambler control words (odd and even), each word with a length of 64 bits.
  - The descrambler core containing the actual descrambler with the stream cipher and the block cipher module.
- A microcontroller interface providing protocol handling for the memory mapped I/O control bus (Philips 90CE201 compatible). This module contains an interrupt request handler and data filters for the retrieval of Conditional Access (CA) information:

- The CA filters select data on the basis of PIDs, and a combination of MPEG-2 section addressing fields. Selected CA data is stored in eighteen 256 byte (constrained random access) buffers which can be read by the microcontroller. The CA message section has a maximum length of 256 bytes. It consists of a 3 bytes long header with Table\_id and section\_length data. The remaining part of the CA message are the CA\_data\_bytes (see Fig.4). If a section is longer than 256 bytes, the data capture is stopped (with an interrupt to the microcontroller) after 256 bytes are in the buffer and the 'section\_to\_long' bit is set. The filters are capable of monitoring 18 CA streams (containing EMM and ECM data) simultaneously. Two different lengths are used for address filtering:
  - 16 filters where the first 7 bytes of the CA\_data\_bytes field are used for address filtering
  - 2 (DVB compliant) filters where the first 17 bytes of the CA\_data\_bytes field are used for address filtering
  - A chip identification byte (value 0x02) can be read by the software from address 0x0003 (see Table 10).

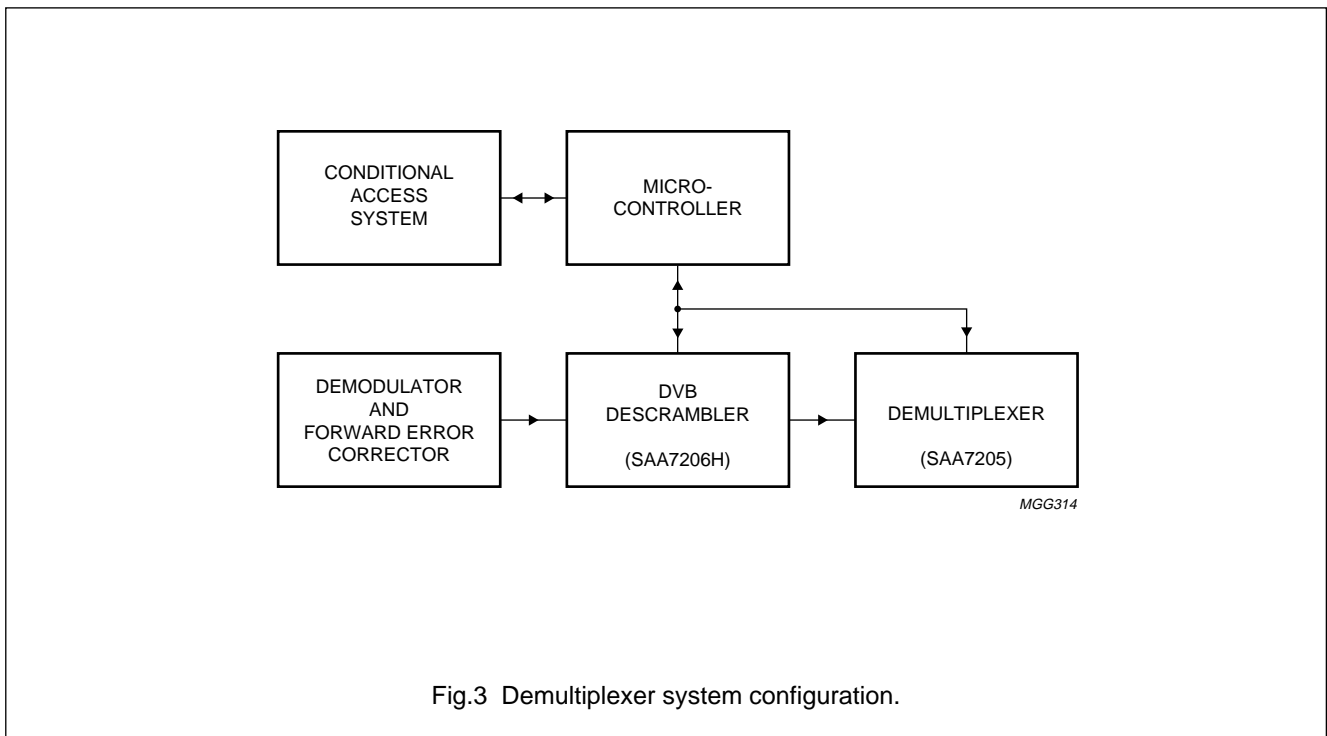

Fig.3 Demultiplexer system configuration.



DVB compliant descrambler

SAA7206H

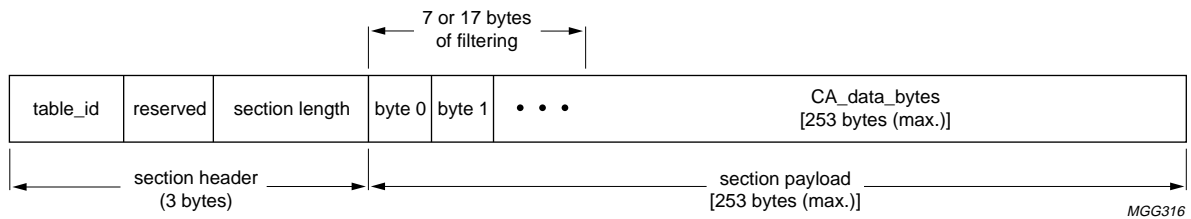

Fig.4 Syntax of the conditional access message.

Table 1 Explanation of Fig.4

SYNTAX	DESCRIPTION
Table_id	8-bit field for identification
Reserved	4-bit field with section_syntax_indicator (1 bit), DVB_reserved (1 bit) and ISO_reserved (2 bits)
Section_length	12-bit field that specifies the number of bytes that follow the section_length field up to the end of the section
CA_data_byte	8-bit field that carries private CA information. Up to the first 17 CA_data_bytes may be used for address filtering

## DVB compliant descrambler

## SAA7206H

### 7.1 MPEG-2 systems parsing

The descrambler receives data from a Forward Error Correction (FEC) decoder (see Fig.5) in a digital TV receiver, in the following input data format:

- 8 data bits via MIN7 to MIN0.
- A valid input data indicator signal (MDV), which is HIGH for consecutive valid bytes and output by either a FEC decoder or a descrambler. Consequently the descrambler input data is allowed to have a 'bursty' nature.
- A transport packet error indicator ( $\overline{\text{MB}}/\text{MB}$ ) which is HIGH for the duration of each 188 byte transport packet in which the FEC decoder found more errors than it could correct. The polarity (active HIGH or LOW) of the error indicator is programmable [bit 'Bad\_polarity' (see Table 10, address 0x0100)].
- A packet sync signal (MSYNC) which goes HIGH at the start of the first byte of a transport packet. Only the rising edge of MSYNC is used for synchronization, the exact HIGH time of the signal is therefore irrelevant.
- A byte strobe signal (MBCLK; < 9 MHz) which indicates consecutive data bytes in the input stream, in the non 9 MHz mode only [bit '9 MHz\_interface' = 0 (see Table 10, address 0x0100)]. MBCLK is used as an enable signal, and transport stream input bytes are sampled on its rising edges. If the input interface is programmed to the 9 MHz mode ('9 MHz\_interface' = 1), the MBCLK signal is ignored and bytes are latched on rising edges of the DCLK.
- A descrambler clock signal (DCLK; 9 MHz; duty cycle range 30 to 55%) which is the processing clock for the descrambler IC. If rising edges of this signal are used to input data to the descrambler, the 9 MHz mode must be programmed (bit '9 MHz\_interface' = 1, see Table 10, address 0x0100).

The parser module in the descrambler parses transport streams compliant to the MPEG-2 systems syntax. MPEG-2 systems specifies a hierarchical two-level multiplex (see Fig.6). The top hierarchical level is the transport stream, consisting of relatively short (188 byte) transport packets. Each transport packet consists of a 4 byte transport header, an optional adaptation field and a payload. The transport header contains a 13-bit PID field. The adaptation field may contain Program Clock Reference (PCR) data and transport private data, among others. Both transport header and optional adaptation fields are parsed by the TS parser module.

The hierarchical multiplex level below the MPEG-2 transport stream is the packetized elementary stream. The PES header is only parsed partially by the DVB descrambler to locate its scrambling control bits. Parsing is performed for all incoming transport packets, and the parser is synchronized to a rising edge on its MSYNC input. A microcontroller can compose a set of 6 PIDs by programming the appropriate registers in the PID filter bank within the descrambler.

These PIDs identify the packets of the streams that are to be descrambled. All 13 bits of PID5 (see Table 10, address 0x0205) can be individually enabled/disabled with a mask of 13 bits (see Table 10, address 0x0209) to enable multiple PID selection. The PIDs of PES scrambled packets must be indicated by programming a logic 1 to the corresponding bit of the 'PIDi\_is\_pes' word (see Table 10, address 0x0206).

MPEG-2 multiplex fields which are related to CA information, in so called sections, are parsed only partly. CA sections containing for instance Entitlement Management Messages (EMM) and Entitlement Control Messages (ECM) etc. are retrieved from the stream and stored in 256 byte buffers in the CA filter module. For the selection of CA data, 18 additional PIDs and section header information (table\_id, address field, both with bit masks) can be programmed. All 13 bits of PID filters 16 and 17 can be individually enabled/disabled with a mask of 13 bits (see Table 10, addresses 0x03A6 and 0x03BA) to enable multiple PID selection for CA messages. A microcontroller may access data in the 256 byte CA buffers (each filter has its own buffer thus 18 in total) for software based parsing and processing.

DVB compliant descrambler

SAA7206H

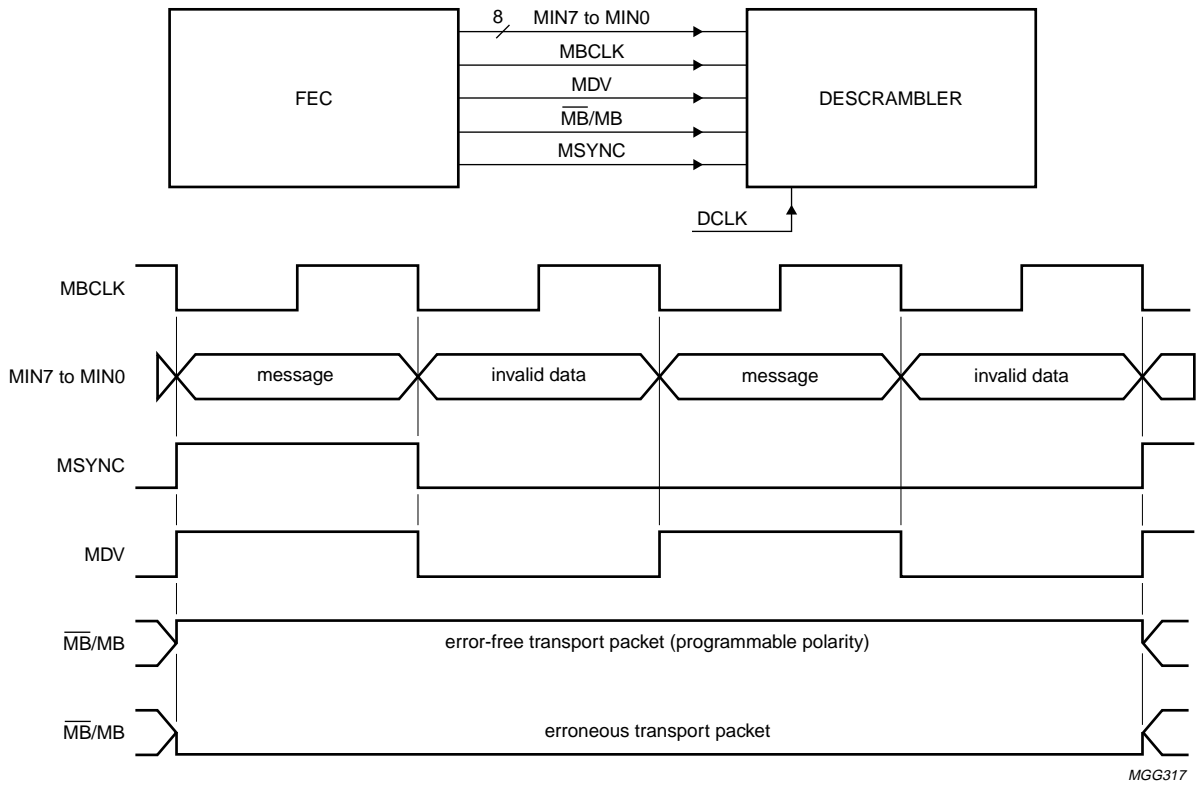

Fig.5 Signal constellation FEC decoder - descrambler Interfacing.

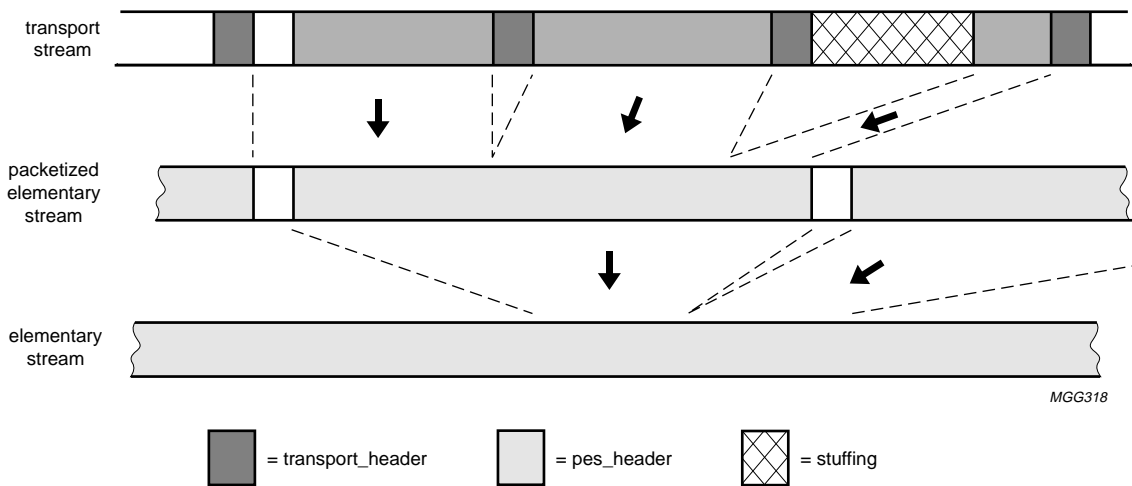

Fig.6 MPEG-2 two level hierarchical demultiplexing.

## DVB compliant descrambler

## SAA7206H

### 7.2 PES level descrambling

PES level descrambling is possible in accordance with the recommendations of the DVB standard with the DVB descrambler IC. The actual restrictions however, required by the DVB descrambler IC, are less strict than to the recommendations in the DVB standard. The restrictions for PES level descrambling imposed by the IC are as follows:

- Scrambling shall only occur at one level (TS or PES) and is not allowed to occur at both levels simultaneously
- The complete PES header must be present in exactly one TS packet. Consequently, the size of a PES packet header shall not exceed 184 bytes
- Only the PES packet data bytes (PES payload) are descrambled
- TS packets resulting from scrambling at PES level are not chained and thus are independent. Consequently, the internal descrambler algorithms (stream decipher and block decipher) are initialized at the start of each (PES scrambled) TS packet payload.

In order to be able to distinguish between sections and PES packets, a PID for a PES scrambled packet is indicated by programming the according 'PIDI\_is\_pes' bit (see Table 10, address 0x0206) to logic 1. If the payload\_unit\_start\_indicator bit is set in the TS packet header and the 'PIDI\_is\_pes' bit is set for a particular PID, the PES scrambling control bits, which are present in the PES header, are stored in the accessible 'pes\_sc\_PIDI' register (see Table 10, address 0x0208).

Descrambling at TS level always has priority over descrambling at PES level. Consequently, PES level descrambling is only possible when the transport\_scrambling\_control bits in the TS header are '00'. In that situation the payload of the PES packets is descrambled using the scrambling control bits of the 'pes\_sc\_PIDI' register.

**Remark:** PID masking (for PID5) should not be combined with PES level descrambling. Only one pair of PES scrambling control bits per PID is stored in an Internal register. Thus interleaving of PES messages, which can occur in the situation of multiple PID selection, can give the wrong descrambling result. As a consequence the microcontroller must program the 'PID5\_is\_pes' bit (see Table 10, address 0x0206) to logic 0 when multiple PID selection is used.

### 7.3 Descrambler core

The descrambler core consists of three modules:

- A PID filter which selects packets for descrambling
- A control word bank containing 6 sets (odd and even) of control words and a Default Control Word (DCW)
- The super descrambler core with the implementation of the stream decipherment and the block decipherment algorithms.

The PID filter contains 6 registers which hold data in the format indicated in Fig.7. Six individual PIDs are stored to identify 6 packet streams. All bits of PID5 (see Table 10, address 0x0205) can be masked with the 'PID5\_mask' (see Table 10, address 0x209), to enable descrambling on multiple PIDs. To disable a bit of PID5 with the 'PID5\_mask' a logic 0 must be programmed. After a power-on reset pulse all mask bits are preset to logic 1.

To each PID a 3-bit Control Word Pair Index pointer (CWPI) is attached. A CWPI prescribes which control word pair, consisting of odd and even control words, has to be used to initialize the DVB descrambler for payloads of packets with the associated PID. After a power-on reset all CWPIs are set to '111' to enable a correct initialization of the conditional access system.

If two or more programmed PIDs match the PID of the TS packet at the same time (while the CWPI value of the programmed PIDs is not equal to '110' or '111'), the programmed PID with the lower index number has a higher priority. However, the default control word, when enabled, has the highest priority.

Thus, the built-in priority (HIGH-to-LOW transition) for the programmed PIDs is; DCW, PID0, PID1, PID2, PID3, PID4 and PID5.

A 2-bit scrambling\_control field is present in the TS packet header and in the PES header (ts\_sc1 and ts\_sc0 and pes\_sc1 and pes\_sc0 respectively). The bits in this header field indicate whether the TS packet or PES payload is scrambled or not. In addition, these bits also indicate which control word (odd or even) of a control word pair was used to initialize the DVB descrambler, as indicated in Tables 2 and 3.

## DVB compliant descrambler

## SAA7206H

If the payload of a packet is descrambled, the descrambler subsequently resets the scrambling\_control bits in the TS or PES header (to '00'). For each of the 6 PIDs in the PID filter bank the values of the TS scrambling\_control bits are stored in a microcontroller accessible register, prior to descrambling [bits: 'ts\_sc\_PIDi1' and 'ts\_sc\_PIDi0'; (see Table 10, address 0x0208), 'i' is in the range 5 to 0]. For each of the 6 PIDs in the PID filter bank, of which the corresponding PIDi\_is\_pes bit (see Table 10, address 0x0206) is also set to logic 1, the values of the PES scrambling\_control bits are stored in a microcontroller accessible register, prior to descrambling [bits: 'pes\_sc\_PIDi1' and 'pes\_sc\_PIDi0' (see Table 10, address 0x0208) 'i' is in the range 5 to 0]. TS and PES scrambling\_control retrieval is independent of the value of the CWPI.

**Table 2** Definition of the bits in the PES scrambling\_control field

VALUE	DESCRIPTION
00	data is not scrambled
01	data is not scrambled
10	data is scrambled with the EVEN control word
11	data is scrambled with the ODD control word

**Table 3** Definition of the bits in the TS scrambling\_control field

VALUE	DESCRIPTION
00	data is not scrambled
01	data is scrambled with the default control word
10	data is scrambled with the EVEN control word
11	data is scrambled with the ODD control word

**Remark:** The payloads of packets with TS scrambling\_control bits equal to '01' are descrambled using the default control word, regardless of their PID and/or CWPI values. Thus, even PIDs which are not programmed in the PID filter bank are descrambled with the DCW should transport\_scrambling\_control = '01'. For PIDs in the PID filter bank, if transport\_scrambling\_control = '01', the payload is descrambled with the default control word, regardless of the value of the associated CWPI. If the default CW is invalid however ['DCW\_valid' = 0 (see Table 10, address 0x0206)], DCW based descrambling is disabled. Descrambling using the DCW is only possible on TS packet level.

The control word bank contains storage space for 6 control word pairs and a default control word. A control word pair consists of 2 CWs and an odd and even CW, as indicated in Table 4. A control word contains 64 bits. In conjunction with the control word selection mechanism given in Table 4, the CW bank allows any CW pair to be used with any PID. All PIDs may, therefore, use their own specific CW pair, but all of them may also share one CW pair.

The super descrambler algorithm is implemented in the core of the descrambler. Descrambling is performed on the payload of a transport packet or a PES. The transport header, the (optional) adaptation field and the PES header are excepted.

DVB compliant descrambler

SAA7206H

**Table 4** Descrambler control word storage; see Table 10

CONTROL WORD (128 BITS)		ADDRESS
Control word 0 odd	Control word 0 even	0x1000 to 0x1007
Control word 1 odd	Control word 1 even	0x1008 to 0x100F
Control word 2 odd	Control word 2 even	0x1010 to 0x1017
Control word 3 odd	Control word 3 even	0x1018 to 0x101F
Control word 4 odd	Control word 4 even	0x1020 to 0x1027
Control word 5 odd	Control word 5 even	0x1028 to 0x102F
Default control word	–	0x1030 to 0x1033

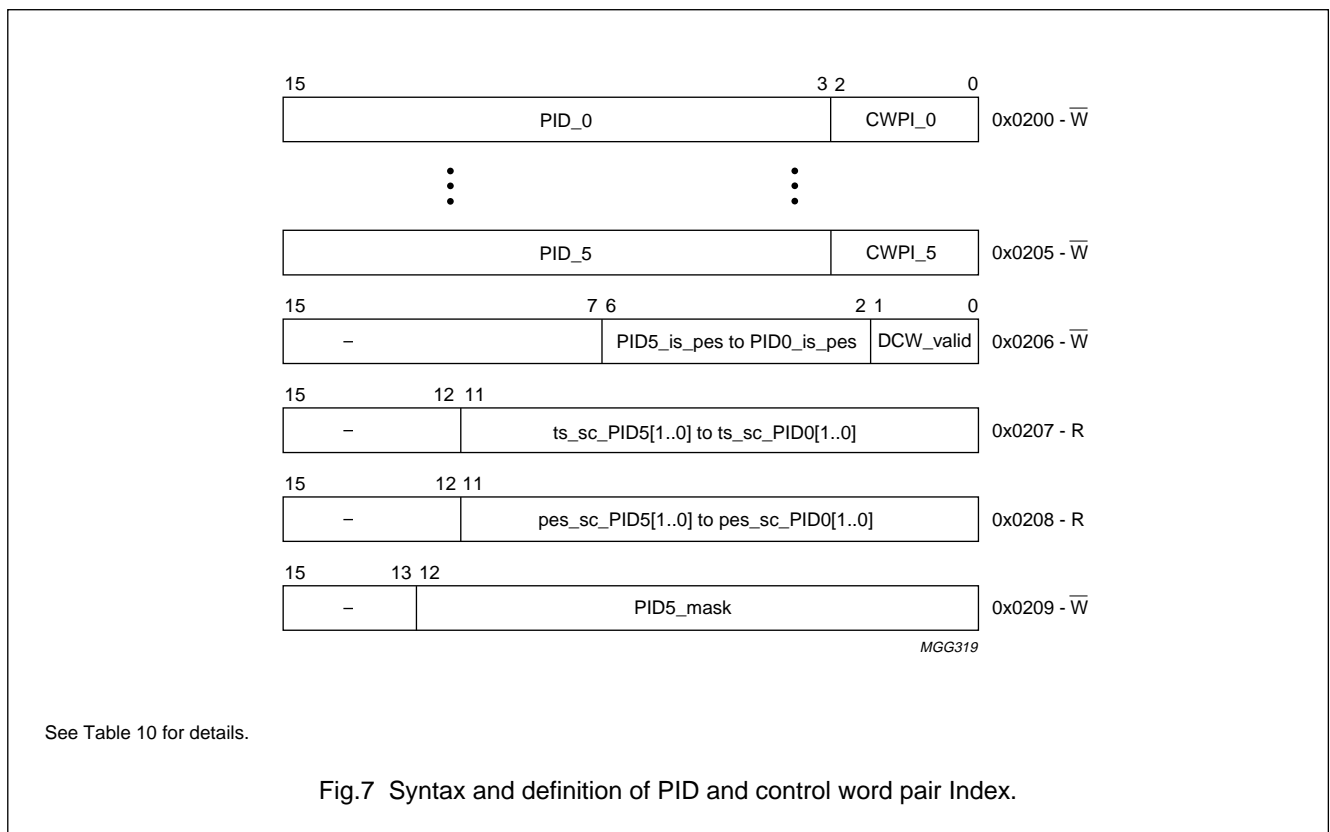

**Table 5** CWPI values; see Fig.7

CWPI VALUE	DESCRIPTION
0 0 0	select control word pair 0
0 0 1	select control word pair 1
0 1 0	select control word pair 2
0 1 1	select control word pair 3
1 0 0	select control word pair 4
1 0 1	select control word pair 5
1 1 0	DO NOT descramble
1 1 1	DO NOT descramble

# DVB compliant descrambler

# SAA7206H

## 7.4 Microcontroller interface

The microcontroller interface provides a means of communication between a system controller (for instance "Philips 90CE201") in a digital TV receiver and the descrambler internal registers and buffers. The physical interface consists of:

- DAT7 to DAT0; an 8-bit wide bidirectional data bus. Data and address information are multiplexed on this bus.
- $\overline{DCS}$ ; an active LOW chip select signal. The descrambler only responds to microcontroller communication if this signal is driven LOW.
- $R/\overline{W}$ ; an active HIGH read signal, indicating that the microcontroller is attempting to read data from registers or buffers inside the descrambler. If this signal is LOW, data is being written to registers or buffers inside the descrambler.
- A1 and A0; a 2-bit address bus. If the least significant address bit (0) is logic 0, the most significant byte of a 16-bit register is addressed, otherwise the least significant byte is selected. If the most significant address bit (1) is logic 1 DAT7 to DAT0 carries the address information, otherwise it will carry control data.
- $\overline{IRQ}$ ; an active LOW (open-drain output) interrupt request signal. An interrupt is set if one of the 15 bits in the descramblers internal interrupt register is set. The interrupt mechanism consists of three 15-bit registers and one 4-bit register, as illustrated in Fig.8. The interrupt status register enables the microcontroller to monitor the momentary status of the interrupts. This is particularly useful during read operations in the descramblers CA buffers, as the interrupt status bits in question ['flt0\_stat', 'flt1\_stat', etc. (see Table 10, addresses 0x0002 and 0x0004)] are reset when the buffers have been emptied or released.

The interrupt mask register (see Table 10, address 0x0001) prevents individual interrupts from resetting  $\overline{IRQ}$  (to logic 0). The interrupt status bits are logically ANDed with the mask. If a rising edge occurs on one of the resulting signals, it is latched into the interrupt register, thus resetting  $\overline{IRQ}$ .

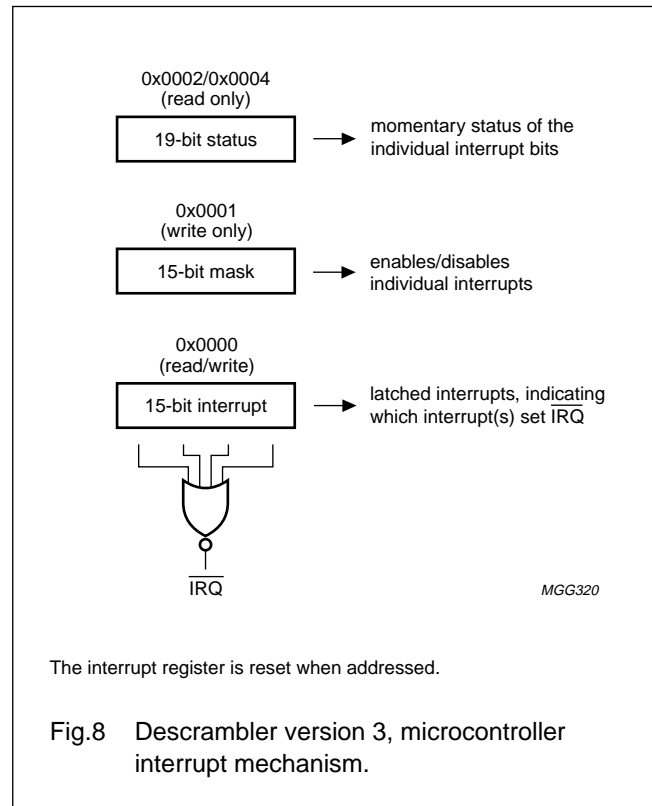

The interrupt register is reset when addressed.

Fig.8 Descrambler version 3, microcontroller interrupt mechanism.

Table 6 Definition of interrupt mechanism; see Fig.8

BIT NUMBER	MEANING OF INTERRUPT
0	filter 0 retrieved CA data
1	filter 1 retrieved CA data
2	filter 2 retrieved CA data
3	filter 3 retrieved CA data
4	filter 4 retrieved CA data
5	filter 5 retrieved CA data
6	filter 6 retrieved CA data
7	filter 7 retrieved CA data
8	filter 8 retrieved CA data
9	filter 9 retrieved CA data
10	filter 10 retrieved CA data
11	filter 11 retrieved CA data
12	filter 12 retrieved CA data
13	filter 13 retrieved CA data
14	filter 14, 15, 16 or 17 retrieved CA data
15	empty

# DVB compliant descrambler

# SAA7206H

The interrupt register itself is reset (to 0000000000000000) as soon as it is addressed (0x0000) by the microcontroller.

A typical example of communication between microcontroller and descrambler is illustrated in Fig.9. The descrambler contains an auto increment address counter which can be loaded by performing a write address operation. The present operation, whether read or write, is now performed on the current address. The next operation, whether read or write, is performed on the current address plus 1.

**Remark:** Avoid resetting the auto increment address counter to 0x0000, when not handling interrupts, as addressing it causes the interrupt register to be reset. Consequently, interrupt information might be lost.

The descrambler internal register and buffer addresses are organized as illustrated in Fig.10. The first 4 address bits (15 to 12) are used to select either the descrambler registers (equals 0) or one of the descrambler buffers (ranges 1 and 2).

In the buffer mode, the remaining address bits (11 to 0) are part of the word address (range depending on the buffer, see Table 10). In the register mode, bits 11 to 8 specify the register unit number (see Fig.10). The remaining 8 bits of the address (7 to 0) indicate specific register addresses within a selected unit. The address range in a specific register unit depends on the number of registers present and is different for each unit. For details refer to Table 10.

The CA filter module in the microcontroller interface unit is capable of accessing general CA messages (ECM and EMM, etc.) in the transport stream. The CA filter module consists of 18 filters and 18 buffers of 256 bytes each, thus each filter has its own data buffer. The 18 filters are divided into two types of filters, which are specified in Table 9. For each filter the 'table\_id' of the section (the first byte of the section see Fig.9), can be masked.

The architecture of the 9 CA filter pairs is shown in Fig.11.

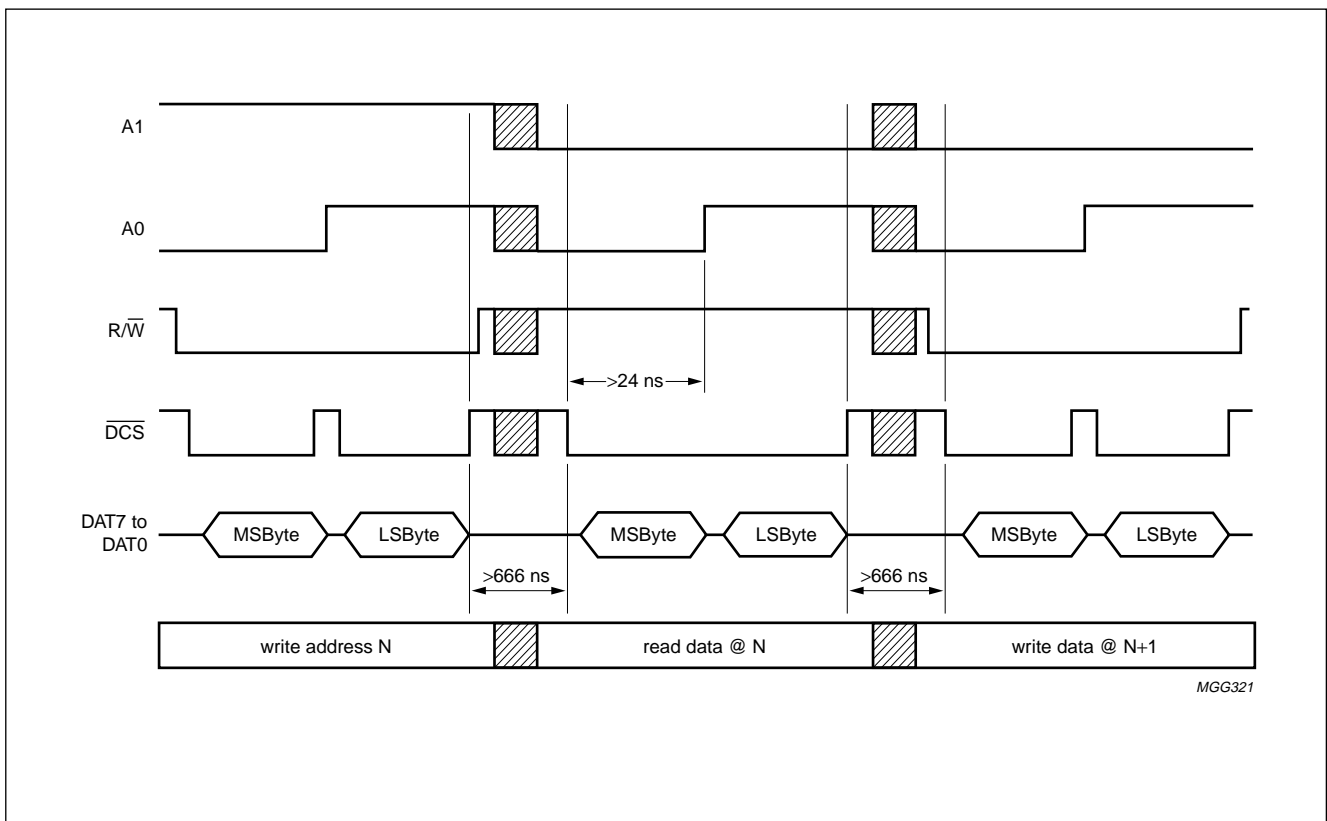

MGG321

The descrambler internal register address is incremented automatically.

Fig.9 Microcontroller descrambler communication (example).



DVB compliant descrambler

SAA7206H

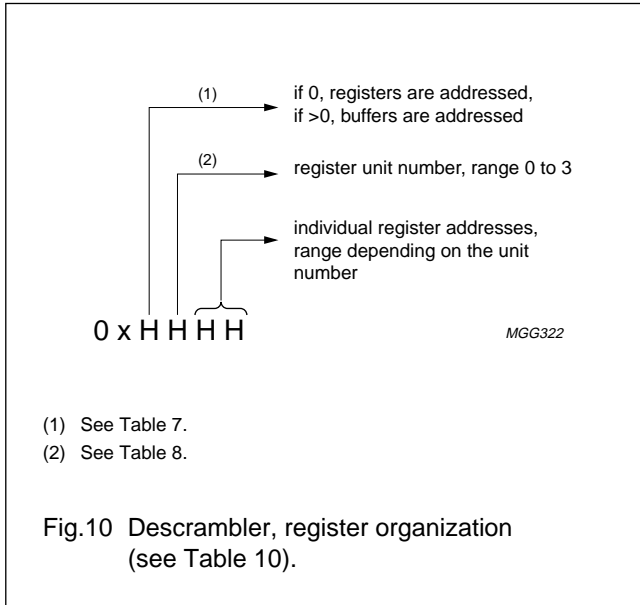

Table 7 Buffer contents

BUFFER NUMBER	BUFFER CONTENTS
1	CW bank
2	CA data buffers for filters 0 to 15
3	CA data buffers for filters 16 and 17

Table 8 Unit contents

REGISTER UNIT NUMBER	UNIT CONTENTS
0	interrupt request handling control
1	parser input control
2	PID filter bank control
3	CA filtering control

Table 9 Specification of the number of CA\_data\_bytes which can be used for address filtering in the three types of filters in the CA filter module (all bits in the filter can be masked individually)

FILTER NUMBER	NUMBER OF FILTERS	FILTER LENGTH (BYTES)	PID MASKABLE
Filters 0 to 15	16	7	no
Filters 16 and 17 (DVB compliant)	2	17	yes

The filter consists of 18 section detectors. Each section detector selects and retrieves section data for CA\_messages on the basis of:

- PID; which is maskable only for filters 16 and 17
- Table\_id; which is maskable for all filters
- For filters 0 to 15; the first 7 bytes in the section payload, which are maskable for all filters (see Fig.4)
- For filters 16 and 17; the first 17 bytes in the section payload, which are maskable
- For all filters (see Fig.4).

The CA data detected by a certain filter is stored in the 256 byte buffer, only if its buffer is empty. As soon as an entire section of CA data is stored, an interrupt is generated (see Table 10, address 0x0000).

The 18 section detectors can be separately enabled, to avoid unnecessary interrupts. The 'filter fired' registers enable the microcontroller to track which filter caused a buffer to be loaded (see Table 10, addresses 0x0300 and 0x0301).

The maximum section length of a conditional access message is 256 bytes. If the section length of a message is higher, data acquisition into the buffer is stopped after 256 bytes and an interrupt signal (plus filter fired signal) is generated as normal. In this (erroneous) situation the 'section\_to\_long' bit of the filter is also set, which can be read by the microcontroller (see Table 10).

The CA filters allow retrieval of multiple consecutive CA messages, even if these messages have identical selection criteria. For this purpose the 18 filters are grouped in 9 filter pairs (0 and 1, 2 and 3 to 16 and 17). Each of the CA filters in a pair can be programmed equivalently. To prevent two filters from firing at the same time the 'equal conditions' bits of the appropriate filter pair can be programmed to logic 1. As a result, the filter with the even (equals lowest) index number (for instance filter\_8 of filter pair 8 and 9) fires at the first occurrence of a matching section. If, at the time of the second occurrence of a matching section, the buffer of the filter with the even index number is still occupied, the other filter (with odd index number) of a filter pair fires, thus storing the section data in its buffer.

---

## DVB compliant descrambler

## SAA7206H

---

If the microcontroller decides to read data from one of the CA buffers (see Table 10, address range filter\_0: 0x2000 to 0x207F to filter\_17: 0x2880 to 0x28FF) it can determine when to stop reading in two ways. It can periodically poll the 'flt0\_stat' to 'flt17\_stat' bits in the interrupt status register (see Table 10, address 0x0002 and 0x0004). Each of these bits goes LOW as soon as the last valid section data is read from the associated CA buffer.

Another possibility is to read the 'high\_flt\_address' word ('haddr7 to 0', Table 10, addresses 0x0302 to 0x0313). The high address indicates the number of valid section words (1 word = 2 bytes) that were written into the buffer. This number equals the number of read cycles that has to be performed to retrieve all valid data from the buffer.

If the buffer contents have to be removed without being read, the microcontroller can write a logic 1 to the 'rst\_bf17-0' bit (see Table 10, address 0x0314 and 0x0315) thus releasing the buffer. Another possibility is to perform a write address operation with a value of haddr7 to haddr0 plus buffer base address. The internal auto increment address counter is thus set to the last word in the buffer, causing the interrupt status bit to be reset and the filters to be reactivated, after having been idle during buffer emptying.

If, during the acquisition of a CA message, one of the TS packets composing a message contains an error ('transport\_error\_indicator' = '1') the erroneous TS packet is removed and CA message acquisition is restarted. Thus the complete CA message is lost when at least one of the TS packets which composes this message contains an error. Duplicate TS packets containing CA messages are also removed.

### 7.5 Output interfacing

The output data stream consists of a sequence of bytes. A new byte is present at the data output pins DATO7 to DATO0 at each rising edge of the descrambler chip clock DCLK. The control signals SYNCO and DVO are a delayed (9 MHz) version of the input interface signals MSYNC and MDV respectively. By this form of delay correction the relationship between the data and control signals is maintained.

The  $\overline{\text{MB}}$ /MB and MBCLK signals are not output to the demultiplexer. The descrambler converts the  $\overline{\text{MB}}$ /MB signal to the transport\_error\_indicator bit in the TS packets. At the descrambler output all information is consequently contained in the stream. MBCLK is only used to clock data into the descrambler, interfacing to the demultiplexer is performed using the 9 MHz DCLK, which is generated by the demultiplexer.

### 7.6 Boundary scan test

The DVB compliant descrambler is equipped with a 5-pins test port interface for Boundary Scan Test (BST). The implementation is in accordance with the BST standard.

DVB compliant descrambler

SAA7206H

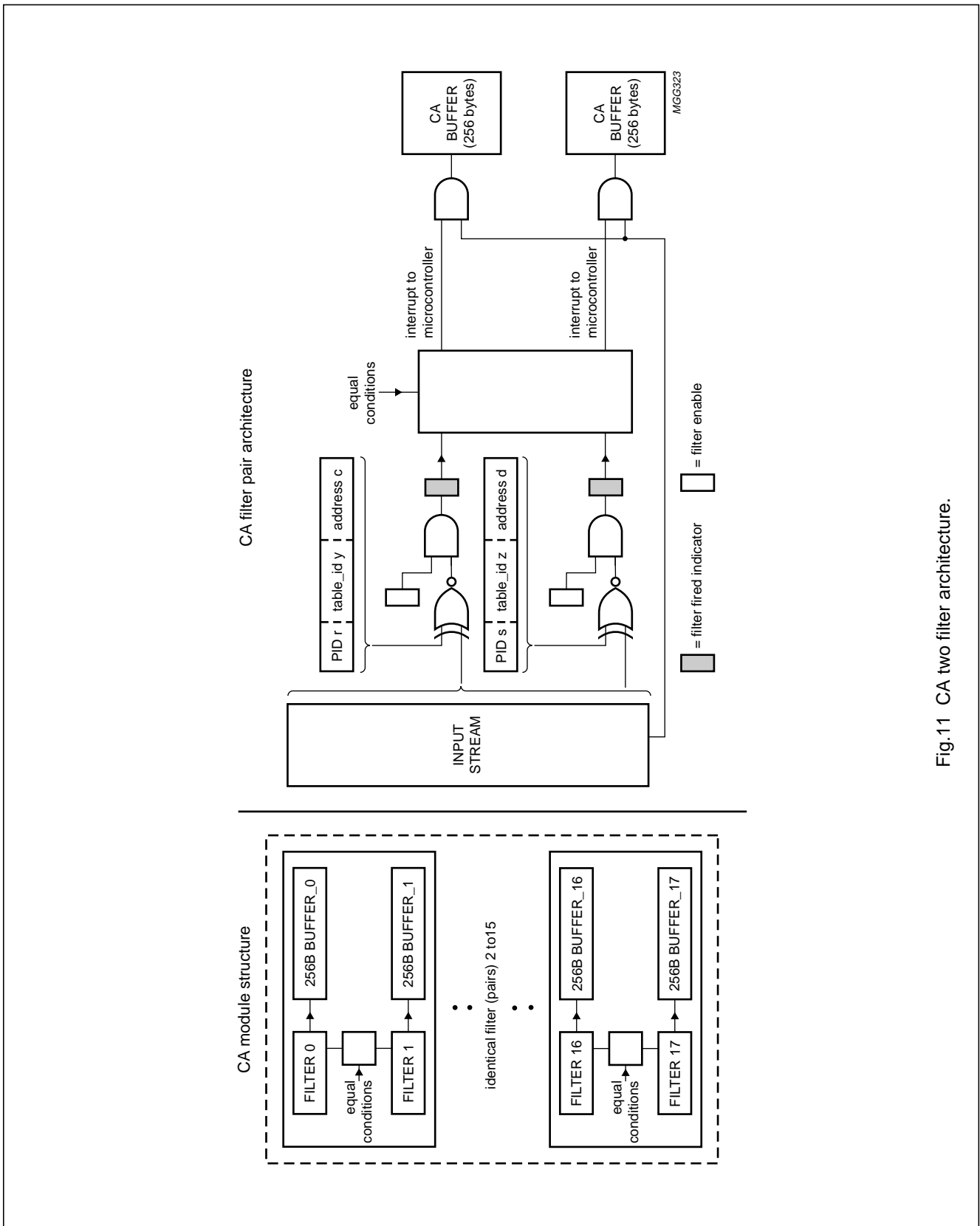

Fig.11 CA two filter architecture.

## DVB compliant descrambler

## SAA7206H

## 7.7 Programming the descrambler

Table 10 Descrambler programming.

REGISTER FUNCTION	ADDRESS (HEX)	BITS											
		15/7	14/6	13/5	12/4	11/3	10/2	9/1	8/0				
IRPT	0x0000- R/W	flt7_irp	flt14-17_irp	flt13_irp	flt12_irp	flt11_irp	flt10_irp	flt9_irp	flt8_irp				
IRPT_MASK	0x0001- R/W	msk7	msk6	msk5	msk4	msk3	msk2	msk1	msk0				
IRPT_STATUS	0x0002- R	flt7_stat	flt14-17_stat	flt13_stat	flt12_stat	flt11_stat	flt10_stat	flt9_stat	flt8_stat				
CHIP_ IDENTIFICATION	0x0003- R	0	0	0	0	0	0	1	1				
IRPT_STATUS_ FLT14-17	0x0004- R	-	-	-	-	flt17_stat	flt16_stat	flt15_stat	flt14_stat				
EMPTY	0x0005 to 0x00FF	-	-	-	-	-	-	-	-				
PRS_INP_CTRL	0x0100- W	-	-	-	-	-	-	-	-			bad_ polarity	9 MHz_ interface
EMPTY	0x0101 to 0x01FF	-	-	-	-	-	-	-	-				
PID0, CWPI0	0x0200- W	pid12	pid11	pid10	pid9	pid8	pid7	pid6	pid5				
PID1, CWPI1	0x0201- W	pid4	pid3	pid2	pid1	pid0	pid0	pid0	pid0				
PID2, CWPI2	0x0202- W	pid12	pid11	pid10	pid9	pid8	pid7	pid6	pid5				
PID3, CWPI3	0x0203- W	pid4	pid3	pid2	pid1	pid0	pid0	pid0	pid0				
PID4, CWPI4	0x0204- W	pid12	pid11	pid10	pid9	pid8	pid7	pid6	pid5				
PID5, CWPI5	0x0205- W	pid4	pid3	pid2	pid1	pid0	pid0	pid0	pid0				



DVB compliant descrambler

SAA7206H

REGISTER FUNCTION	ADDRESS (HEX)	BITS							
		15/7	14/6	13/5	12/4	11/3	10/2	9/1	8/0
FLT4 STATUS	0x0306- R	section to_long hadr4_7	- hadr4_6	- hadr4_5	- hadr4_4	- hadr4_3	- hadr4_2	- hadr4_1	- hadr4_0
FLT5 STATUS	0x0307- R	section to_long hadr5_7	- hadr5_6	- hadr5_5	- hadr5_4	- hadr5_3	- hadr5_2	- hadr5_1	- hadr5_0
FLT6 STATUS	0x0308- R	section to_long hadr6_7	- hadr6_6	- hadr6_5	- hadr6_4	- hadr6_3	- hadr6_2	- hadr6_1	- hadr6_0
FLT7 STATUS	0x0309- R	section to_long hadr7_7	- hadr7_6	- hadr7_5	- hadr7_4	- hadr7_3	- hadr7_2	- hadr7_1	- hadr7_0
FLT8 STATUS	0x030A- R	section to_long hadr8_7	- hadr8_6	- hadr8_5	- hadr8_4	- hadr8_3	- hadr8_2	- hadr8_1	- hadr8_0
FLT9 STATUS	0x030B- R	section to_long hadr9_7	- hadr9_6	- hadr9_5	- hadr9_4	- hadr9_3	- hadr9_2	- hadr9_1	- hadr9_0
FLT10 STATUS	0x030C- R	section to_long hadr10_7	- hadr10_6	- hadr10_5	- hadr10_4	- hadr10_3	- hadr10_2	- hadr10_1	- hadr10_0
FLT11 STATUS	0x030D- R	section to_long hadr11_7	- hadr11_6	- hadr11_5	- hadr11_4	- hadr11_3	- hadr11_2	- hadr11_1	- hadr11_0
FLT12 STATUS	0x030E- R	section to_long hadr12_7	- hadr12_6	- hadr12_5	- hadr12_4	- hadr12_3	- hadr12_2	- hadr12_1	- hadr12_0
FLT13 STATUS	0x030F- R	section to_long hadr13_7	- hadr13_6	- hadr13_5	- hadr13_4	- hadr13_3	- hadr13_2	- hadr13_1	- hadr13_0

DVB compliant descrambler

SAA7206H

REGISTER FUNCTION	ADDRESS (HEX)	BITS										
		15/7	14/6	13/5	12/4	11/3	10/2	9/1	8/0			
FLT14 STATUS	0x0310- R	section to_long	-	-	-	-	-	-	-	-	-	-
		hdr14_7	hdr14_6	hdr14_5	hdr14_4	hdr14_3	hdr14_2	hdr14_1	hdr14_0			
FLT15 STATUS	0x0311- R	section to_long	-	-	-	-	-	-	-	-	-	-
		hdr15_7	hdr15_6	hdr15_5	hdr15_4	hdr15_3	hdr15_2	hdr15_1	hdr15_0			
FLT16 STATUS	0x0312- R	section to_long	-	-	-	-	-	-	-	-	-	-
		hdr16_7	hdr16_6	hdr16_5	hdr16_4	hdr16_3	hdr16_2	hdr16_1	hdr16_0			
FLT17 STATUS	0x0313- R	section to_long	-	-	-	-	-	-	-	-	-	-
		hdr17_7	hdr17_6	hdr17_5	hdr17_4	hdr17_3	hdr17_2	hdr17_1	hdr17_0			
RESET BUFFER 16 and 17	0x0314- $\bar{W}$	-	-	-	-	-	-	-	-	-	-	-
		-	-	-	-	-	-	-	-	-	-	-
RESET BUFFER 0 to 15	0x0315- $\bar{W}$	rst_bf15	rst_bf14	rst_bf13	rst_bf12	rst_bf11	rst_bf10	rst_bf9	rst_bf8			
		rst_bf7	rst_bf6	rst_bf5	rst_bf4	rst_bf3	rst_bf2	rst_bf1	rst_bf0			
FLT0 CNTRL	0x0316- $\bar{W}$	-	equal_cond	enable	pid12	pid11	pid10	pid9	pid8			
		pid7	pid6	pid5	pid4	pid3	pid2	pid1	pid0			
FLT0 TBL_ID	0x0317- $\bar{W}$	msk7	msk6	msk5	msk4	msk3	msk2	msk1	msk0			
		tblid_7	tblid_6	tblid_5	tblid_4	tblid_3	tblid_2	tblid_1	tblid_0			
FLT0 ADR BYTE0	0x0318- $\bar{W}$	msk7	msk6	msk5	msk4	msk3	msk2	msk1	msk0			
FLT0 ADR BYTE1	0x0319- W	adr7	adr6	adr5	adr4	adr3	adr2	adr1	adr0			
		msk7	msk6	msk5	msk4	msk3	msk2	msk1	msk0			
FLT0 ADR BYTE2	0x031A- W	adr7	adr6	adr5	adr4	adr3	adr2	adr1	adr0			
		msk7	msk6	msk5	msk4	msk3	msk2	msk1	msk0			
FLT0 ADR BYTE3	0x031B- $\bar{W}$	adr7	adr6	adr5	adr4	adr3	adr2	adr1	adr0			
		msk7	msk6	msk5	msk4	msk3	msk2	msk1	msk0			
FLT0 ADR BYTE4	0x031C- $\bar{W}$	msk7	msk6	msk5	msk4	msk3	msk2	msk1	msk0			
		adr7	adr6	adr5	adr4	adr3	adr2	adr1	adr0			

DVB compliant descrambler

SAA7206H

REGISTER FUNCTION	ADDRESS (HEX)	BITS									
		15/7	14/6	13/5	12/4	11/3	10/2	9/1	8/0		
FLT0 ADR BYTE5	0x031D- $\bar{W}$	msk7	msk6	msk5	msk4	msk3	msk2	msk1	msk0		
		adr7	adr6	adr5	adr4	adr3	adr2	adr1	adr0		
FLT0 ADR BYTE6	0x031E- $\bar{W}$	msk7	msk6	msk5	msk4	msk3	msk2	msk1	msk0		
		adr7	adr6	adr5	adr4	adr3	adr2	adr1	adr0		
FLT1 CNTRL	0x031F- $\bar{W}$	-	equal_cond	enable	pid12	pid11	pid10	pid9	pid8		
		pid7	pid6	pid5	pid4	pid3	pid2	pid1	pid0		
FLT1 TBL_ID	0x0320- $\bar{W}$	msk7	msk6	msk5	msk4	msk3	msk2	msk1	msk0		
		tblid_7	tblid_6	tblid_5	tblid_4	tblid_3	tblid_2	tblid_1	tblid_0		
FLT1 ADR BYTE0	0x0321- $\bar{W}$	msk7	msk6	msk5	msk4	msk3	msk2	msk1	msk0		
		adr7	adr6	adr5	adr4	adr3	adr2	adr1	adr0		
FLT1 ADR BYTE1	0x0322- $\bar{W}$	msk7	msk6	msk5	msk4	msk3	msk2	msk1	msk0		
		adr7	adr6	adr5	adr4	adr3	adr2	adr1	adr0		
FLT1 ADR BYTE2	0x0323- $\bar{W}$	msk7	msk6	msk5	msk4	msk3	msk2	msk1	msk0		
		adr7	adr6	adr5	adr4	adr3	adr2	adr1	adr0		
FLT1 ADR BYTE3	0x0324- $\bar{W}$	msk7	msk6	msk5	msk4	msk3	msk2	msk1	msk0		
		adr7	adr6	adr5	adr4	adr3	adr2	adr1	adr0		
FLT1 ADR BYTE4	0x0325- $\bar{W}$	msk7	msk6	msk5	msk4	msk3	msk2	msk1	msk0		
		adr7	adr6	adr5	adr4	adr3	adr2	adr1	adr0		
FLT1 ADR BYTE5	0x0326- $\bar{W}$	msk7	msk6	msk5	msk4	msk3	msk2	msk1	msk0		
		adr7	adr6	adr5	adr4	adr3	adr2	adr1	adr0		
FLT1 ADR BYTE6	0x0327- $\bar{W}$	msk7	msk6	msk5	msk4	msk3	msk2	msk1	msk0		
		adr7	adr6	adr5	adr4	adr3	adr2	adr1	adr0		
FLT2 CNTRL	0x0328- $\bar{W}$	-	equal_cond	enable	pid12	pid11	pid10	pid9	pid8		
		pid7	pid6	pid5	pid4	pid3	pid2	pid1	pid0		
FLT2 TBL_ID	0x0329- $\bar{W}$	msk7	msk6	msk5	msk4	msk3	msk2	msk1	msk0		
		tblid_7	tblid_6	tblid_5	tblid_4	tblid_3	tblid_2	tblid_1	tblid_0		
FLT2 ADR BYTE0	0x032A- $\bar{W}$	msk7	msk6	msk5	msk4	msk3	msk2	msk1	msk0		
		adr7	adr6	adr5	adr4	adr3	adr2	adr1	adr0		
FLT2 ADR BYTE1	0x032B- $\bar{W}$	msk7	msk6	msk5	msk4	msk3	msk2	msk1	msk0		
		adr7	adr6	adr5	adr4	adr3	adr2	adr1	adr0		



DVB compliant descrambler

SAA7206H

REGISTER FUNCTION	ADDRESS (HEX)	BITS							
		15/7	14/6	13/5	12/4	11/3	10/2	9/1	8/0
FLT2 ADR BYTE2	0x032C- $\bar{W}$	msk7	msk6	msk5	msk4	msk3	msk2	msk1	msk0
		adr7	adr6	adr5	adr4	adr3	adr2	adr1	adr0
FLT2 ADR BYTE3	0x032D- $\bar{W}$	msk7	msk6	msk5	msk4	msk3	msk2	msk1	msk0
		adr7	adr6	adr5	adr4	adr3	adr2	adr1	adr0
FLT2 ADR BYTE4	0x032E- $\bar{W}$	msk7	msk6	msk5	msk4	msk3	msk2	msk1	msk0
		adr7	adr6	adr5	adr4	adr3	adr2	adr1	adr0
FLT2 ADR BYTE5	0x032F- $\bar{W}$	msk7	msk6	msk5	msk4	msk3	msk2	msk1	msk0
		adr7	adr6	adr5	adr4	adr3	adr2	adr1	adr0
FLT2 ADR BYTE6	0x0330- $\bar{W}$	msk7	msk6	msk5	msk4	msk3	msk2	msk1	msk0
		adr7	adr6	adr5	adr4	adr3	adr2	adr1	adr0
FLT3 CNTRL	0x0331- $\bar{W}$	-	equal_cond	enable	pid12	pid11	pid10	pid9	pid8
		pid7	pid6	pid5	pid4	pid3	pid2	pid1	pid0
FLT3 TBL_ID	0x0332- $\bar{W}$	msk7	msk6	msk5	msk4	msk3	msk2	msk1	msk0
		tblid_7	tblid_6	tblid_5	tblid_4	tblid_3	tblid_2	tblid_1	tblid_0
FLT3 ADR BYTE0	0x0333- $\bar{W}$	msk7	msk6	msk5	msk4	msk3	msk2	msk1	msk0
		adr7	adr6	adr5	adr4	adr3	adr2	adr1	adr0
FLT3 ADR BYTE1	0x0334- $\bar{W}$	msk7	msk6	msk5	msk4	msk3	msk2	msk1	msk0
		adr7	adr6	adr5	adr4	adr3	adr2	adr1	adr0
FLT3 ADR BYTE2	0x0335- $\bar{W}$	msk7	msk6	msk5	msk4	msk3	msk2	msk1	msk0
		adr7	adr6	adr5	adr4	adr3	adr2	adr1	adr0
FLT3 ADR BYTE3	0x0336- $\bar{W}$	msk7	msk6	msk5	msk4	msk3	msk2	msk1	msk0
		adr7	adr6	adr5	adr4	adr3	adr2	adr1	adr0
FLT3 ADR BYTE4	0x0337- $\bar{W}$	msk7	msk6	msk5	msk4	msk3	msk2	msk1	msk0
		adr7	adr6	adr5	adr4	adr3	adr2	adr1	adr0
FLT3 ADR BYTE5	0x0338- $\bar{W}$	msk7	msk6	msk5	msk4	msk3	msk2	msk1	msk0
		adr7	adr6	adr5	adr4	adr3	adr2	adr1	adr0
FLT3 DR BYTE6	0x0339- $\bar{W}$	msk7	msk6	msk5	msk4	msk3	msk2	msk1	msk0
		adr7	adr6	adr5	adr4	adr3	adr2	adr1	adr0
FLT4 CNTRL	0x033A- $\bar{W}$	-	equal_cond	enable	pid12	pid11	pid10	pid9	pid8
		pid7	pid6	pid5	pid4	pid3	pid2	pid1	pid0

## DVB compliant descrambler

## SAA7206H

REGISTER FUNCTION	ADDRESS (HEX)	BITS							
		15/7	14/6	13/5	12/4	11/3	10/2	9/1	8/0
FLT4 TBL_ID	0x033B- $\bar{W}$	msk7	msk6	msk5	msk4	msk3	msk2	msk1	msk0
		tblid_7	tblid_6	tblid_5	tblid_4	tblid_3	tblid_2	tblid_1	tblid_0
FLT4 ADR BYTE0	0x033C- $\bar{W}$	msk7	msk6	msk5	msk4	msk3	msk2	msk1	msk0
		adr7	adr6	adr5	adr4	adr3	adr2	adr1	adr0
FLT4 ADR BYTE1	0x033D- $\bar{W}$	msk7	msk6	msk5	msk4	msk3	msk2	msk1	msk0
		adr7	adr6	adr5	adr4	adr3	adr2	adr1	adr0
FLT4 ADR BYTE2	0x033E- $\bar{W}$	msk7	msk6	msk5	msk4	msk3	msk2	msk1	msk0
		adr7	adr6	adr5	adr4	adr3	adr2	adr1	adr0
FLT4 ADR BYTE3	0x033F- $\bar{W}$	msk7	msk6	msk5	msk4	msk3	msk2	msk1	msk0
		adr7	adr6	adr5	adr4	adr3	adr2	adr1	adr0
FLT4 ADR BYTE4	0x0340- $\bar{W}$	msk7	msk6	msk5	msk4	msk3	msk2	msk1	msk0
		adr7	adr6	adr5	adr4	adr3	adr2	adr1	adr0
FLT4 ADR BYTE5	0x0341- $\bar{W}$	msk7	msk6	msk5	msk4	msk3	msk2	msk1	msk0
		adr7	adr6	adr5	adr4	adr3	adr2	adr1	adr0
FLT4 ADR BYTE6	0x0342- $\bar{W}$	msk7	msk6	msk5	msk4	msk3	msk2	msk1	msk0
		adr7	adr6	adr5	adr4	adr3	adr2	adr1	adr0
FLT5 CNTRL	0x0343- $\bar{W}$	-	equal_cond	enable	pid12	pid11	pid10	pid9	pid8
		pid7	pid6	pid5	pid4	pid3	pid2	pid1	pid0
FLT5 TBL_ID	0x0344- $\bar{W}$	msk7	msk6	msk5	msk4	msk3	msk2	msk1	msk0
		tblid_7	tblid_6	tblid_5	tblid_4	tblid_3	tblid_2	tblid_1	tblid_0
FLT5 ADR BYTE0	0x0345- $\bar{W}$	msk7	msk6	msk5	msk4	msk3	msk2	msk1	msk0
		adr7	adr6	adr5	adr4	adr3	adr2	adr1	adr0
FLT5 ADR BYTE1	0x0346- $\bar{W}$	msk7	msk6	msk5	msk4	msk3	msk2	msk1	msk0
		adr7	adr6	adr5	adr4	adr3	adr2	adr1	adr0
FLT5 ADR BYTE2	0x0347- $\bar{W}$	msk7	msk6	msk5	msk4	msk3	msk2	msk1	msk0
		adr7	adr6	adr5	adr4	adr3	adr2	adr1	adr0
FLT5 ADR BYTE3	0x0348- $\bar{W}$	msk7	msk6	msk5	msk4	msk3	msk2	msk1	msk0
		adr7	adr6	adr5	adr4	adr3	adr2	adr1	adr0
FLT5 ADR BYTE4	0x0349- $\bar{W}$	msk7	msk6	msk5	msk4	msk3	msk2	msk1	msk0
		adr7	adr6	adr5	adr4	adr3	adr2	adr1	adr0

## DVB compliant descrambler

## SAA7206H

REGISTER FUNCTION	ADDRESS (HEX)	BITS							
		15/7	14/6	13/5	12/4	11/3	10/2	9/1	8/0
FLT5 ADR BYTE5	0x034A- $\bar{W}$	msk7	msk6	msk5	msk4	msk3	msk2	msk1	msk0
		adr7	adr6	adr5	adr4	adr3	adr2	adr1	adr0
FLT5 ADR BYTE6	0x034B- $\bar{W}$	msk7	msk6	msk5	msk4	msk3	msk2	msk1	msk0
		adr7	adr6	adr5	adr4	adr3	adr2	adr1	adr0
FLT6 CNTRL	0x034C- $\bar{W}$	-	equal_cond	enable	pid12	pid11	pid10	pid9	pid8
		pid7	pid6	pid5	pid4	pid3	pid2	pid1	pid0
FLT6 TBL_ID	0x034D- $\bar{W}$	msk7	msk6	msk5	msk4	msk3	msk2	msk1	msk0
		tblid_7	tblid_6	tblid_5	tblid_4	tblid_3	tblid_2	tblid_1	tblid_0
FLT6 ADR BYTE0	0x034E- $\bar{W}$	msk7	msk6	msk5	msk4	msk3	msk2	msk1	msk0
		adr7	adr6	adr5	adr4	adr3	adr2	adr1	adr0
FLT6 ADR BYTE1	0x034F- $\bar{W}$	msk7	msk6	msk5	msk4	msk3	msk2	msk1	msk0
		adr7	adr6	adr5	adr4	adr3	adr2	adr1	adr0
FLT6 ADR BYTE2	0x0350- $\bar{W}$	msk7	msk6	msk5	msk4	msk3	msk2	msk1	msk0
		adr7	adr6	adr5	adr4	adr3	adr2	adr1	adr0
FLT6 ADR BYTE3	0x0351- $\bar{W}$	msk7	msk6	msk5	msk4	msk3	msk2	msk1	msk0
		adr7	adr6	adr5	adr4	adr3	adr2	adr1	adr0
FLT6 ADR BYTE4	0x0352- $\bar{W}$	msk7	msk6	msk5	msk4	msk3	msk2	msk1	msk0
		adr7	adr6	adr5	adr4	adr3	adr2	adr1	adr0
FLT6 ADR BYTE5	0x0353- $\bar{W}$	msk7	msk6	msk5	msk4	msk3	msk2	msk1	msk0
		adr7	adr6	adr5	adr4	adr3	adr2	adr1	adr0
FLT6 ADR BYTE6	0x0354- $\bar{W}$	msk7	msk6	msk5	msk4	msk3	msk2	msk1	msk0
		adr7	adr6	adr5	adr4	adr3	adr2	adr1	adr0
FLT7 CNTRL	0x0355- $\bar{W}$	-	equal_cond	enable	pid12	pid11	pid10	pid9	pid8
		pid7	pid6	pid5	pid4	pid3	pid2	pid1	pid0
FLT7 TBL_ID	0x0356- $\bar{W}$	msk7	msk6	msk5	msk4	msk3	msk2	msk1	msk0
		tblid_7	tblid_6	tblid_5	tblid_4	tblid_3	tblid_2	tblid_1	tblid_0
FLT7 ADR BYTE0	0x0357- $\bar{W}$	msk7	msk6	msk5	msk4	msk3	msk2	msk1	msk0
		adr7	adr6	adr5	adr4	adr3	adr2	adr1	adr0
FLT7 ADR BYTE1	0x0358- $\bar{W}$	msk7	msk6	msk5	msk4	msk3	msk2	msk1	msk0
		adr7	adr6	adr5	adr4	adr3	adr2	adr1	adr0

DVB compliant descrambler

SAA7206H

REGISTER FUNCTION	ADDRESS (HEX)	BITS									
		15/7	14/6	13/5	12/4	11/3	10/2	9/1	8/0		
FLT7 ADR BYTE2	0x0359- $\bar{W}$	msk7	msk6	msk5	msk4	msk3	msk2	msk1	msk0		
		adr7	adr6	adr5	adr4	adr3	adr2	adr1	adr0		
FLT7 ADR BYTE3	0x035A- $\bar{W}$	msk7	msk6	msk5	msk4	msk3	msk2	msk1	msk0		
		adr7	adr6	adr5	adr4	adr3	adr2	adr1	adr0		
FLT7 ADR BYTE4	0x035B- $\bar{W}$	msk7	msk6	msk5	msk4	msk3	msk2	msk1	msk0		
		adr7	adr6	adr5	adr4	adr3	adr2	adr1	adr0		
FLT7 ADR BYTE5	0x035C- $\bar{W}$	msk7	msk6	msk5	msk4	msk3	msk2	msk1	msk0		
		adr7	adr6	adr5	adr4	adr3	adr2	adr1	adr0		
FLT7 ADR BYTE6	0x035D- $\bar{W}$	msk7	msk6	msk5	msk4	msk3	msk2	msk1	msk0		
		adr7	adr6	adr5	adr4	adr3	adr2	adr1	adr0		
FLT8 CNTRL	0x035E- $\bar{W}$	-	equal_cond	enable	pid12	pid11	pid10	pid9	pid8		
		pid7	pid6	pid5	pid4	pid3	pid2	pid1	pid0		
FLT8 TBL_ID	0x031F- $\bar{W}$	msk7	msk6	msk5	msk4	msk3	msk2	msk1	msk0		
		tblid_7	tblid_6	tblid_5	tblid_4	tblid_3	tblid_2	tblid_1	tblid_0		
FLT8 ADR BYTE0	0x0360- $\bar{W}$	msk7	msk6	msk5	msk4	msk3	msk2	msk1	msk0		
		adr7	adr6	adr5	adr4	adr3	adr2	adr1	adr0		
FLT8 ADR BYTE1	0x0361- $\bar{W}$	msk7	msk6	msk5	msk4	msk3	msk2	msk1	msk0		
		adr7	adr6	adr5	adr4	adr3	adr2	adr1	adr0		
FLT8 ADR BYTE2	0x0362- $\bar{W}$	msk7	msk6	msk5	msk4	msk3	msk2	msk1	msk0		
		adr7	adr6	adr5	adr4	adr3	adr2	adr1	adr0		
FLT8 ADR BYTE3	0x0363- $\bar{W}$	msk7	msk6	msk5	msk4	msk3	msk2	msk1	msk0		
		adr7	adr6	adr5	adr4	adr3	adr2	adr1	adr0		
FLT8 ADR BYTE4	0x0364- $\bar{W}$	msk7	msk6	msk5	msk4	msk3	msk2	msk1	msk0		
		adr7	adr6	adr5	adr4	adr3	adr2	adr1	adr0		
FLT8 ADR BYTE5	0x0365- $\bar{W}$	msk7	msk6	msk5	msk4	msk3	msk2	msk1	msk0		
		adr7	adr6	adr5	adr4	adr3	adr2	adr1	adr0		
FLT8 ADR BYTE6	0x0366- $\bar{W}$	msk7	msk6	msk5	msk4	msk3	msk2	msk1	msk0		
		adr7	adr6	adr5	adr4	adr3	adr2	adr1	adr0		
FLT9 CNTRL	0x0367- $\bar{W}$	-	equal_cond	enable	pid12	pid11	pid10	pid9	pid8		
		pid7	pid6	pid5	pid4	pid3	pid2	pid1	pid0		

## DVB compliant descrambler

## SAA7206H

REGISTER FUNCTION	ADDRESS (HEX)	BITS							
		15/7	14/6	13/5	12/4	11/3	10/2	9/1	8/0
FLT9 TBL_ID	0x0368- $\bar{W}$	msk7	msk6	msk5	msk4	msk3	msk2	msk1	msk0
		tblid_7	tblid_6	tblid_5	tblid_4	tblid_3	tblid_2	tblid_1	tblid_0
FLT9 ADR BYTE0	0x0369- $\bar{W}$	msk7	msk6	msk5	msk4	msk3	msk2	msk1	msk0
FLT9 ADR BYTE1	0x036A- $\bar{W}$	adr7	adr6	adr5	adr4	adr3	adr2	adr1	adr0
		msk7	msk6	msk5	msk4	msk3	msk2	msk1	msk0
FLT9 ADR BYTE2	0x036B- $\bar{W}$	adr7	adr6	adr5	adr4	adr3	adr2	adr1	adr0
		msk7	msk6	msk5	msk4	msk3	msk2	msk1	msk0
FLT9 ADR BYTE3	0x036C- $\bar{W}$	msk7	msk6	msk5	msk4	msk3	msk2	msk1	msk0
		adr7	adr6	adr5	adr4	adr3	adr2	adr1	adr0
FLT9 ADR BYTE4	0x036D- $\bar{W}$	msk7	msk6	msk5	msk4	msk3	msk2	msk1	msk0
		adr7	adr6	adr5	adr4	adr3	adr2	adr1	adr0
FLT9 ADR BYTE5	0x036E- $\bar{W}$	msk7	msk6	msk5	msk4	msk3	msk2	msk1	msk0
		adr7	adr6	adr5	adr4	adr3	adr2	adr1	adr0
FLT9 ADR BYTE6	0x036F- $\bar{W}$	msk7	msk6	msk5	msk4	msk3	msk2	msk1	msk0
		adr7	adr6	adr5	adr4	adr3	adr2	adr1	adr0
FLT10 CNTRL	0x0370- $\bar{W}$	-	equal_cond	enable	pid12	pid11	pid10	pid9	pid8
		pid7	pid6	pid5	pid4	pid3	pid2	pid1	pid0
FLT10 TBL_ID	0x0371- $\bar{W}$	msk7	msk6	msk5	msk4	msk3	msk2	msk1	msk0
		tblid_7	tblid_6	tblid_5	tblid_4	tblid_3	tblid_2	tblid_1	tblid_0
FLT10 ADR BYTE0	0x0372- $\bar{W}$	msk7	msk6	msk5	msk4	msk3	msk2	msk1	msk0
		adr7	adr6	adr5	adr4	adr3	adr2	adr1	adr0
FLT10 ADR BYTE1	0x0373- $\bar{W}$	msk7	msk6	msk5	msk4	msk3	msk2	msk1	msk0
		adr7	adr6	adr5	adr4	adr3	adr2	adr1	adr0
FLT10 ADR BYTE2	0x0374- $\bar{W}$	msk7	msk6	msk5	msk4	msk3	msk2	msk1	msk0
		adr7	adr6	adr5	adr4	adr3	adr2	adr1	adr0
FLT10 ADR BYTE3	0x0375- $\bar{W}$	msk7	msk6	msk5	msk4	msk3	msk2	msk1	msk0
		adr7	adr6	adr5	adr4	adr3	adr2	adr1	adr0
FLT10 ADR BYTE4	0x0376- $\bar{W}$	msk7	msk6	msk5	msk4	msk3	msk2	msk1	msk0
		adr7	adr6	adr5	adr4	adr3	adr2	adr1	adr0

DVB compliant descrambler

SAA7206H

REGISTER FUNCTION	ADDRESS (HEX)	BITS							
		15/7	14/6	13/5	12/4	11/3	10/2	9/1	8/0
FLT10 ADR BYTE5	0x0377- $\bar{W}$	msk7	msk6	msk5	msk4	msk3	msk2	msk1	msk0
		adr7	adr6	adr5	adr4	adr3	adr2	adr1	adr0
FLT10 ADR BYTE6	0x0378- $\bar{W}$	msk7	msk6	msk5	msk4	msk3	msk2	msk1	msk0
		adr7	adr6	adr5	adr4	adr3	adr2	adr1	adr0
FLT11 CNTRL	0x0379- $\bar{W}$	-	equal_cond	enable	pid12	pid11	pid10	pid9	pid8
		pid7	pid6	pid5	pid4	pid3	pid2	pid1	pid0
FLT11 TBL_ID	0x037A- $\bar{W}$	msk7	msk6	msk5	msk4	msk3	msk2	msk1	msk0
		tblid_7	tblid_6	tblid_5	tblid_4	tblid_3	tblid_2	tblid_1	tblid_0
FLT11 ADR BYTE0	0x037B- $\bar{W}$	msk7	msk6	msk5	msk4	msk3	msk2	msk1	msk0
		adr7	adr6	adr5	adr4	adr3	adr2	adr1	adr0
FLT11 ADR BYTE1	0x037C- $\bar{W}$	msk7	msk6	msk5	msk4	msk3	msk2	msk1	msk0
		adr7	adr6	adr5	adr4	adr3	adr2	adr1	adr0
FLT11 ADR BYTE2	0x037D- $\bar{W}$	msk7	msk6	msk5	msk4	msk3	msk2	msk1	msk0
		adr7	adr6	adr5	adr4	adr3	adr2	adr1	adr0
FLT11 ADR BYTE3	0x037E- $\bar{W}$	msk7	msk6	msk5	msk4	msk3	msk2	msk1	msk0
		adr7	adr6	adr5	adr4	adr3	adr2	adr1	adr0
FLT11 ADR BYTE4	0x037F- $\bar{W}$	msk7	msk6	msk5	msk4	msk3	msk2	msk1	msk0
		adr7	adr6	adr5	adr4	adr3	adr2	adr1	adr0
FLT11 ADR BYTE5	0x0380- $\bar{W}$	msk7	msk6	msk5	msk4	msk3	msk2	msk1	msk0
		adr7	adr6	adr5	adr4	adr3	adr2	adr1	adr0
FLT11 ADR BYTE6	0x0381- $\bar{W}$	msk7	msk6	msk5	msk4	msk3	msk2	msk1	msk0
		adr7	adr6	adr5	adr4	adr3	adr2	adr1	adr0
FLT12 CNTRL	0x0382- $\bar{W}$	-	equal_cond	enable	pid12	pid11	pid10	pid9	pid8
		pid7	pid6	pid5	pid4	pid3	pid2	pid1	pid0
FLT12 TBL_ID	0x0383- $\bar{W}$	msk7	msk6	msk5	msk4	msk3	msk2	msk1	msk0
		tblid_7	tblid_6	tblid_5	tblid_4	tblid_3	tblid_2	tblid_1	tblid_0
FLT12 ADR BYTE0	0x0384- $\bar{W}$	msk7	msk6	msk5	msk4	msk3	msk2	msk1	msk0
		adr7	adr6	adr5	adr4	adr3	adr2	adr1	adr0
FLT12 ADR BYTE1	0x0385- $\bar{W}$	msk7	msk6	msk5	msk4	msk3	msk2	msk1	msk0
		adr7	adr6	adr5	adr4	adr3	adr2	adr1	adr0

DVB compliant descrambler

SAA7206H

REGISTER FUNCTION	ADDRESS (HEX)	BITS							
		15/7	14/6	13/5	12/4	11/3	10/2	9/1	8/0
FLT12 ADR BYTE2	0x0386- $\bar{W}$	msk7	msk6	msk5	msk4	msk3	msk2	msk1	msk0
		adr7	adr6	adr5	adr4	adr3	adr2	adr1	adr0
FLT12 ADR BYTE3	0x0387- $\bar{W}$	msk7	msk6	msk5	msk4	msk3	msk2	msk1	msk0
		adr7	adr6	adr5	adr4	adr3	adr2	adr1	adr0
FLT12 ADR BYTE4	0x0388- $\bar{W}$	msk7	msk6	msk5	msk4	msk3	msk2	msk1	msk0
		adr7	adr6	adr5	adr4	adr3	adr2	adr1	adr0
FLT12 ADR BYTE5	0x0389- $\bar{W}$	msk7	msk6	msk5	msk4	msk3	msk2	msk1	msk0
		adr7	adr6	adr5	adr4	adr3	adr2	adr1	adr0
FLT12 ADR BYTE6	0x038A- $\bar{W}$	msk7	msk6	msk5	msk4	msk3	msk2	msk1	msk0
		adr7	adr6	adr5	adr4	adr3	adr2	adr1	adr0
FLT13 CNTRL	0x038B- $\bar{W}$	-	equal_cond	enable	pid12	pid11	pid10	pid9	pid8
		pid7	pid6	pid5	pid4	pid3	pid2	pid1	pid0
FLT13 TBL_ID	0x038C- $\bar{W}$	msk7	msk6	msk5	msk4	msk3	msk2	msk1	msk0
		tblid_7	tblid_6	tblid_5	tblid_4	tblid_3	tblid_2	tblid_1	tblid_0
FLT13 ADR BYTE0	0x038D- $\bar{W}$	msk7	msk6	msk5	msk4	msk3	msk2	msk1	msk0
		adr7	adr6	adr5	adr4	adr3	adr2	adr1	adr0
FLT13 ADR BYTE1	0x038E- $\bar{W}$	msk7	msk6	msk5	msk4	msk3	msk2	msk1	msk0
		adr7	adr6	adr5	adr4	adr3	adr2	adr1	adr0
FLT13 ADR BYTE2	0x038F- $\bar{W}$	msk7	msk6	msk5	msk4	msk3	msk2	msk1	msk0
		adr7	adr6	adr5	adr4	adr3	adr2	adr1	adr0
FLT13 ADR BYTE3	0x0390- $\bar{W}$	msk7	msk6	msk5	msk4	msk3	msk2	msk1	msk0
		adr7	adr6	adr5	adr4	adr3	adr2	adr1	adr0
FLT13 ADR BYTE4	0x0391- $\bar{W}$	msk7	msk6	msk5	msk4	msk3	msk2	msk1	msk0
		adr7	adr6	adr5	adr4	adr3	adr2	adr1	adr0
FLT13 ADR BYTE5	0x0392- $\bar{W}$	msk7	msk6	msk5	msk4	msk3	msk2	msk1	msk0
		adr7	adr6	adr5	adr4	adr3	adr2	adr1	adr0
FLT13 ADR BYTE6	0x0393- $\bar{W}$	msk7	msk6	msk5	msk4	msk3	msk2	msk1	msk0
		adr7	adr6	adr5	adr4	adr3	adr2	adr1	adr0
FLT14 CNTRL	0x0394- $\bar{W}$	-	equal_cond	enable	pid12	pid11	pid10	pid9	pid8
		pid7	pid6	pid5	pid4	pid3	pid2	pid1	pid0

DVB compliant descrambler

SAA7206H

REGISTER FUNCTION	ADDRESS (HEX)	BITS							
		15/7	14/6	13/5	12/4	11/3	10/2	9/1	8/0
FLT14 TBL_ID	0x0395- $\bar{W}$	msk7	msk6	msk5	msk4	msk3	msk2	msk1	msk0
		tblid_7	tblid_6	tblid_5	tblid_4	tblid_3	tblid_2	tblid_1	tblid_0
FLT14 ADR BYTE0	0x0396- $\bar{W}$	msk7	msk6	msk5	msk4	msk3	msk2	msk1	msk0
		adr7	adr6	adr5	adr4	adr3	adr2	adr1	adr0
FLT14 ADR BYTE1	0x0397- $\bar{W}$	msk7	msk6	msk5	msk4	msk3	msk2	msk1	msk0
		adr7	adr6	adr5	adr4	adr3	adr2	adr1	adr0
FLT14 ADR BYTE2	0x0398- $\bar{W}$	msk7	msk6	msk5	msk4	msk3	msk2	msk1	msk0
		adr7	adr6	adr5	adr4	adr3	adr2	adr1	adr0
FLT14 ADR BYTE3	0x0399- $\bar{W}$	msk7	msk6	msk5	msk4	msk3	msk2	msk1	msk0
		adr7	adr6	adr5	adr4	adr3	adr2	adr1	adr0
FLT14 ADR BYTE4	0x039A- $\bar{W}$	msk7	msk6	msk5	msk4	msk3	msk2	msk1	msk0
		adr7	adr6	adr5	adr4	adr3	adr2	adr1	adr0
FLT14 ADR BYTE5	0x039B- $\bar{W}$	msk7	msk6	msk5	msk4	msk3	msk2	msk1	msk0
		adr7	adr6	adr5	adr4	adr3	adr2	adr1	adr0
FLT14 ADR BYTE6	0x039C- $\bar{W}$	msk7	msk6	msk5	msk4	msk3	msk2	msk1	msk0
		adr7	adr6	adr5	adr4	adr3	adr2	adr1	adr0
FLT15 CNTRL	0x039D- $\bar{W}$	-	equal_cond	enable	pid12	pid11	pid10	pid9	pid8
		pid7	pid6	pid5	pid4	pid3	pid2	pid1	pid0
FLT15 TBL_ID	0x039E- $\bar{W}$	msk7	msk6	msk5	msk4	msk3	msk2	msk1	msk0
		tblid_7	tblid_6	tblid_5	tblid_4	tblid_3	tblid_2	tblid_1	tblid_0
FLT15 ADR BYTE0	0x039F- $\bar{W}$	msk7	msk6	msk5	msk4	msk3	msk2	msk1	msk0
		adr7	adr6	adr5	adr4	adr3	adr2	adr1	adr0
FLT15 ADR BYTE1	0x03A0- $\bar{W}$	msk7	msk6	msk5	msk4	msk3	msk2	msk1	msk0
		adr7	adr6	adr5	adr4	adr3	adr2	adr1	adr0
FLT15 ADR BYTE2	0x03A1- $\bar{W}$	msk7	msk6	msk5	msk4	msk3	msk2	msk1	msk0
		adr7	adr6	adr5	adr4	adr3	adr2	adr1	adr0
FLT15 ADR BYTE3	0x03A2- $\bar{W}$	msk7	msk6	msk5	msk4	msk3	msk2	msk1	msk0
		adr7	adr6	adr5	adr4	adr3	adr2	adr1	adr0
FLT15 ADR BYTE4	0x03A3- $\bar{W}$	msk7	msk6	msk5	msk4	msk3	msk2	msk1	msk0
		adr7	adr6	adr5	adr4	adr3	adr2	adr1	adr0



DVB compliant descrambler

SAA7206H

REGISTER FUNCTION	ADDRESS (HEX)	BITS							
		15/7	14/6	13/5	12/4	11/3	10/2	9/1	8/0
FLT15 ADR BYTE5	0x03A4- $\bar{W}$	msk7	msk6	msk5	msk4	msk3	msk2	msk1	msk0
		adr7	adr6	adr5	adr4	adr3	adr2	adr1	adr0
FLT15 ADR BYTE6	0x03A5- $\bar{W}$	msk7	msk6	msk5	msk4	msk3	msk2	msk1	msk0
		adr7	adr6	adr5	adr4	adr3	adr2	adr1	adr0
FLT16 PID MASK	0x03A6- $\bar{W}$	-	-	-	msk12	msk11	msk10	msk9	msk8
		msk7	msk6	msk5	msk4	msk3	msk2	msk1	msk0
FLT16 CNTRL	0x03A7- $\bar{W}$	-	equal_cond	enable	pid12	pid11	pid10	pid9	pid8
		pid7	pid6	pid5	pid4	pid3	pid2	pid1	pid0
FLT16 TBL_ID	0x03A8- $\bar{W}$	msk7	msk6	msk5	msk4	msk3	msk2	msk1	msk0
		tblid_7	tblid_6	tblid_5	tblid_4	tblid_3	tblid_2	tblid_1	tblid_0
FLT16 ADR BYTE0	0x03A9- $\bar{W}$	msk7	msk6	msk5	msk4	msk3	msk2	msk1	msk0
		adr7	adr6	adr5	adr4	adr3	adr2	adr1	adr0
FLT16 ADR BYTE1	0x03AA- $\bar{W}$	msk7	msk6	msk5	msk4	msk3	msk2	msk1	msk0
		adr7	adr6	adr5	adr4	adr3	adr2	adr1	adr0
FLT16 ADR BYTE2	0x03AB- $\bar{W}$	msk7	msk6	msk5	msk4	msk3	msk2	msk1	msk0
		adr7	adr6	adr5	adr4	adr3	adr2	adr1	adr0
FLT16 ADR BYTE3	0x03AC- $\bar{W}$	msk7	msk6	msk5	msk4	msk3	msk2	msk1	msk0
		adr7	adr6	adr5	adr4	adr3	adr2	adr1	adr0
FLT16 ADR BYTE4	0x03AD- $\bar{W}$	msk7	msk6	msk5	msk4	msk3	msk2	msk1	msk0
		adr7	adr6	adr5	adr4	adr3	adr2	adr1	adr0
FLT16 ADR BYTE5	0x03AE- $\bar{W}$	msk7	msk6	msk5	msk4	msk3	msk2	msk1	msk0
		adr7	adr6	adr5	adr4	adr3	adr2	adr1	adr0
FLT16 ADR BYTE6	0x03AF- $\bar{W}$	msk7	msk6	msk5	msk4	msk3	msk2	msk1	msk0
		adr7	adr6	adr5	adr4	adr3	adr2	adr1	adr0
FLT16 ADR BYTE7	0x03B0- $\bar{W}$	msk7	msk6	msk5	msk4	msk3	msk2	msk1	msk0
		adr7	adr6	adr5	adr4	adr3	adr2	adr1	adr0
FLT16 ADR BYTE8	0x03B1- $\bar{W}$	msk7	msk6	msk5	msk4	msk3	msk2	msk1	msk0
		adr7	adr6	adr5	adr4	adr3	adr2	adr1	adr0
FLT16 ADR BYTE9	0x03B2- $\bar{W}$	msk7	msk6	msk5	msk4	msk3	msk2	msk1	msk0
		adr7	adr6	adr5	adr4	adr3	adr2	adr1	adr0

DVB compliant descrambler

SAA7206H

REGISTER FUNCTION	ADDRESS (HEX)	BITS							
		15/7	14/6	13/5	12/4	11/3	10/2	9/1	8/0
FLT16 ADR BYTE10	0x03B3- $\bar{W}$	msk7	msk6	msk5	msk4	msk3	msk2	msk1	msk0
		adr7	adr6	adr5	adr4	adr3	adr2	adr1	adr0
FLT16 ADR BYTE11	0x03B4- $\bar{W}$	msk7	msk6	msk5	msk4	msk3	msk2	msk1	msk0
		adr7	adr6	adr5	adr4	adr3	adr2	adr1	adr0
FLT16 ADR BYTE12	0x03B5- $\bar{W}$	msk7	msk6	msk5	msk4	msk3	msk2	msk1	msk0
		adr7	adr6	adr5	adr4	adr3	adr2	adr1	adr0
FLT16 ADR BYTE13	0x03B6- $\bar{W}$	msk7	msk6	msk5	msk4	msk3	msk2	msk1	msk0
		adr7	adr6	adr5	adr4	adr3	adr2	adr1	adr0
FLT16 ADR BYTE14	0x03B7- $\bar{W}$	msk7	msk6	msk5	msk4	msk3	msk2	msk1	msk0
		adr7	adr6	adr5	adr4	adr3	adr2	adr1	adr0
FLT16 ADR BYTE15	0x03B8- $\bar{W}$	msk7	msk6	msk5	msk4	msk3	msk2	msk1	msk0
		adr7	adr6	adr5	adr4	adr3	adr2	adr1	adr0
FLT16 ADR BYTE16	0x03B9- $\bar{W}$	msk7	msk6	msk5	msk4	msk3	msk2	msk1	msk0
		adr7	adr6	adr5	adr4	adr3	adr2	adr1	adr0
FLT17 PID MASK	0x03BA- $\bar{W}$	-	-	-	msk12	msk11	msk10	msk9	msk8
		msk7	msk6	msk5	msk4	msk3	msk2	msk1	msk0
FLT17 CNTRL	0x03BB- $\bar{W}$	-	equal_cond	enable	pid12	pid11	pid10	pid9	pid8
		pid7	pid6	pid5	pid4	pid3	pid2	pid1	pid0
FLT17 TBL_ID	0x03BC- $\bar{W}$	msk7	msk6	msk5	msk4	msk3	msk2	msk1	msk0
		tblid_7	tblid_6	tblid_5	tblid_4	tblid_3	tblid_2	tblid_1	tblid_0
FLT17 ADR BYTE0	0x03BD- $\bar{W}$	msk7	msk6	msk5	msk4	msk3	msk2	msk1	msk0
		adr7	adr6	adr5	adr4	adr3	adr2	adr1	adr0
FLT17 ADR BYTE1	0x03BE- $\bar{W}$	msk7	msk6	msk5	msk4	msk3	msk2	msk1	msk0
		adr7	adr6	adr5	adr4	adr3	adr2	adr1	adr0
FLT17 ADR BYTE2	0x03BF- $\bar{W}$	msk7	msk6	msk5	msk4	msk3	msk2	msk1	msk0
		adr7	adr6	adr5	adr4	adr3	adr2	adr1	adr0
FLT17 ADR BYTE3	0x03C0- $\bar{W}$	msk7	msk6	msk5	msk4	msk3	msk2	msk1	msk0
		adr7	adr6	adr5	adr4	adr3	adr2	adr1	adr0
FLT17 ADR BYTE4	0x03C1- $\bar{W}$	msk7	msk6	msk5	msk4	msk3	msk2	msk1	msk0
		adr7	adr6	adr5	adr4	adr3	adr2	adr1	adr0

DVB compliant descrambler

SAA7206H

REGISTER FUNCTION	ADDRESS (HEX)	BITS							
		15/7	14/6	13/5	12/4	11/3	10/2	9/1	8/0
FLT17 ADR BYTE5	0x03C2- $\bar{W}$	msk7	msk6	msk5	msk4	msk3	msk2	msk1	msk0
		adr7	adr6	adr5	adr4	adr3	adr2	adr1	adr0
FLT17 ADR BYTE6	0x03C3- $\bar{W}$	msk7	msk6	msk5	msk4	msk3	msk2	msk1	msk0
		adr7	adr6	adr5	adr4	adr3	adr2	adr1	adr0
FLT17 ADR BYTE7	0x03C4- $\bar{W}$	msk7	msk6	msk5	msk4	msk3	msk2	msk1	msk0
		adr7	adr6	adr5	adr4	adr3	adr2	adr1	adr0
FLT17 ADR BYTE8	0x03C5- $\bar{W}$	msk7	msk6	msk5	msk4	msk3	msk2	msk1	msk0
		adr7	adr6	adr5	adr4	adr3	adr2	adr1	adr0
FLT17 ADR BYTE9	0x03C6- $\bar{W}$	msk7	msk6	msk5	msk4	msk3	msk2	msk1	msk0
		adr7	adr6	adr5	adr4	adr3	adr2	adr1	adr0
FLT17 ADR BYTE10	0x03C7- $\bar{W}$	msk7	msk6	msk5	msk4	msk3	msk2	msk1	msk0
		adr7	adr6	adr5	adr4	adr3	adr2	adr1	adr0
FLT17 ADR BYTE11	0x03C8- $\bar{W}$	msk7	msk6	msk5	msk4	msk3	msk2	msk1	msk0
		adr7	adr6	adr5	adr4	adr3	adr2	adr1	adr0
FLT17 ADR BYTE12	0x03C9- $\bar{W}$	msk7	msk6	msk5	msk4	msk3	msk2	msk1	msk0
		adr7	adr6	adr5	adr4	adr3	adr2	adr1	adr0
FLT17 ADR BYTE13	0x03CA- $\bar{W}$	msk7	msk6	msk5	msk4	msk3	msk2	msk1	msk0
		adr7	adr6	adr5	adr4	adr3	adr2	adr1	adr0
FLT17 ADR BYTE14	0x03CB- $\bar{W}$	msk7	msk6	msk5	msk4	msk3	msk2	msk1	msk0
		adr7	adr6	adr5	adr4	adr3	adr2	adr1	adr0
FLT17 ADR BYTE15	0x03CC- $\bar{W}$	msk7	msk6	msk5	msk4	msk3	msk2	msk1	msk0
		adr7	adr6	adr5	adr4	adr3	adr2	adr1	adr0
FLT17 ADR BYTE16	0x03CD- $\bar{W}$	msk7	msk6	msk5	msk4	msk3	msk2	msk1	msk0
		adr7	adr6	adr5	adr4	adr3	adr2	adr1	adr0
EMPTY	0x03CE to 0x0FFF	-	-	-	-	-	-	-	-
		-	-	-	-	-	-	-	-
CTRL WRD0_ EVEN3	0x1000- $\bar{W}$	cw63	cw62	cw61	cw60	cw59	cw58	cw57	cw56
		cw55	cw54	cw53	cw52	cw51	cw50	cw49	cw48
CTRL_ WRD0_ EVEN2	0x1001- $\bar{W}$	cw47	cw46	cw45	cw44	cw43	cw42	cw41	cw40
		cw39	cw38	cw37	cw36	cw35	cw34	cw33	cw32

## DVB compliant descrambler

## SAA7206H

REGISTER FUNCTION	ADDRESS (HEX)	BITS							
		15/7	14/6	13/5	12/4	11/3	10/2	9/1	8/0
CTRL_WRD0_ EVEN1	0x1002- $\bar{W}$	cw31	cw30	cw29	cw28	cw27	cw26	cw25	cw24
		cw23	cw22	cw21	cw20	cw19	cw18	cw17	cw16
CTRL_WRD0_ EVEN0	0x1003- $\bar{W}$	cw15	cw14	cw13	cw12	cw11	cw10	cw9	cw8
		cw7	cw6	cw5	cw4	cw3	cw2	cw1	cw0
CTRL_WRD0_ ODD3	0x1004- $\bar{W}$	cw63	cw62	cw61	cw60	cw59	cw58	cw57	cw56
		cw55	cw54	cw53	cw52	cw51	cw50	cw49	cw48
CTRL_WRD0_ ODD2	0x1005- $\bar{W}$	cw47	cw46	cw45	cw44	cw43	cw42	cw41	cw40
		cw39	cw38	cw37	cw36	cw35	cw34	cw33	cw32
CTRL_WRD0_ ODD1	0x1006- $\bar{W}$	cw31	cw30	cw29	cw28	cw27	cw26	cw25	cw24
		cw23	cw22	cw21	cw20	cw19	cw18	cw17	cw16
CTRL_WRD0_ ODD0	0x1007- $\bar{W}$	cw15	cw14	cw13	cw12	cw11	cw10	cw9	cw8
		cw7	cw6	cw5	cw4	cw3	cw2	cw1	cw0
CTRL_WRD1_ EVEN3	0x1008- $\bar{W}$	cw63	cw62	cw61	cw60	cw59	cw58	cw57	cw56
		cw55	cw54	cw53	cw52	cw51	cw50	cw49	cw48
CTRL_WRD1_ EVEN2	0x1009- $\bar{W}$	cw47	cw46	cw45	cw44	cw43	cw42	cw41	cw40
		cw39	cw38	cw37	cw36	cw35	cw34	cw33	cw32
CTRL_WRD1_ EVEN1	0x100A- $\bar{W}$	cw31	cw30	cw29	cw28	cw27	cw26	cw25	cw24
		cw23	cw22	cw21	cw20	cw19	cw18	cw17	cw16
CTRL_WRD1_ EVEN0	0x100B- $\bar{W}$	cw15	cw14	cw13	cw12	cw11	cw10	cw9	cw8
		cw7	cw6	cw5	cw4	cw3	cw2	cw1	cw0
CTRL_WRD1_ ODD3	0x100C- $\bar{W}$	cw63	cw62	cw61	cw60	cw59	cw58	cw57	cw56
		cw55	cw54	cw53	cw52	cw51	cw50	cw49	cw48
CTRL_WRD1_ ODD2	0x100D- $\bar{W}$	cw47	cw46	cw45	cw44	cw43	cw42	cw41	cw40
		cw39	cw38	cw37	cw36	cw35	cw34	cw33	cw32
CTRL_WRD1_ ODD1	0x100E- $\bar{W}$	cw31	cw30	cw29	cw28	cw27	cw26	cw25	cw24
		cw23	cw22	cw21	cw20	cw19	cw18	cw17	cw16
CTRL_WRD1_ ODD0	0x100F- $\bar{W}$	cw15	cw14	cw13	cw12	cw11	cw10	cw9	cw8
		cw7	cw6	cw5	cw4	cw3	cw2	cw1	cw0
CTRL_WRD2_ EVEN3	0x1010- $\bar{W}$	cw63	cw62	cw61	cw60	cw59	cw58	cw57	cw56
		cw55	cw54	cw53	cw52	cw51	cw50	cw49	cw48

DVB compliant descrambler

SAA7206H

REGISTER FUNCTION	ADDRESS (HEX)	BITS							
		15/7	14/6	13/5	12/4	11/3	10/2	9/1	8/0
CTRL_WRD2_EVEN2	0x1011- $\bar{W}$	cw47	cw46	cw45	cw44	cw43	cw42	cw41	cw40
		cw39	cw38	cw37	cw36	cw35	cw34	cw33	cw32
CTRL_WRD2_EVEN1	0x1012- $\bar{W}$	cw31	cw30	cw29	cw28	cw27	cw26	cw25	cw24
		cw23	cw22	cw21	cw20	cw19	cw18	cw17	cw16
CTRL_WRD2_EVEN0	0x1013- $\bar{W}$	cw15	cw14	cw13	cw12	cw11	cw10	cw9	cw8
		cw7	cw6	cw5	cw4	cw3	cw2	cw1	cw0
CTRL_WRD2_ODD3	0x1014- $\bar{W}$	cw63	cw62	cw61	cw60	cw59	cw58	cw57	cw56
		cw55	cw54	cw53	cw52	cw51	cw50	cw49	cw48
CTRL_WRD2_ODD2	0x1015- $\bar{W}$	cw47	cw46	cw45	cw44	cw43	cw42	cw41	cw40
		cw39	cw38	cw37	cw36	cw35	cw34	cw33	cw32
CTRL_WRD2_ODD1	0x1016- $\bar{W}$	cw31	cw30	cw29	cw28	cw27	cw26	cw25	cw24
		cw23	cw22	cw21	cw20	cw19	cw18	cw17	cw16
CTRL_WRD2_ODD0	0x1017- $\bar{W}$	cw15	cw14	cw13	cw12	cw11	cw10	cw9	cw8
		cw7	cw6	cw5	cw4	cw3	cw2	cw1	cw0
CTRL_WRD3_EVEN3	0x1018- $\bar{W}$	cw63	cw62	cw61	cw60	cw59	cw58	cw57	cw56
		cw55	cw54	cw53	cw52	cw51	cw50	cw49	cw48
CTRL_WRD3_EVEN2	0x1019- $\bar{W}$	cw47	cw46	cw45	cw44	cw43	cw42	cw41	cw40
		cw39	cw38	cw37	cw36	cw35	cw34	cw33	cw32
CTRL_WRD3_EVEN1	0x101A- $\bar{W}$	cw31	cw30	cw29	cw28	cw27	cw26	cw25	cw24
		cw23	cw22	cw21	cw20	cw19	cw18	cw17	cw16
CTRL_WRD3_EVEN0	0x101B- $\bar{W}$	cw15	cw14	cw13	cw12	cw11	cw10	cw9	cw8
		cw7	cw6	cw5	cw4	cw3	cw2	cw1	cw0
CTRL_WRD3_ODD3	0x101C- $\bar{W}$	cw63	cw62	cw61	cw60	cw59	cw58	cw57	cw56
		cw55	cw54	cw53	cw52	cw51	cw50	cw49	cw48
CTRL_WRD3_ODD2	0x101D- $\bar{W}$	cw47	cw46	cw45	cw44	cw43	cw42	cw41	cw40
		cw39	cw38	cw37	cw36	cw35	cw34	cw33	cw32
CTRL_WRD3_ODD1	0x101E- $\bar{W}$	cw31	cw30	cw29	cw28	cw27	cw26	cw25	cw24
		cw23	cw22	cw21	cw20	cw19	scw18	cw17	cw16
CTRL_WRD3_ODD0	0x101F- $\bar{W}$	cw15	cw14	cw13	cw12	cw11	cw10	cw9	cw8
		cw7	cw6	cw5	cw4	cw3	cw2	cw1	cw0

DVB compliant descrambler

SAA7206H

REGISTER FUNCTION	ADDRESS (HEX)	BITS							
		15/7	14/6	13/5	12/4	11/3	10/2	9/1	8/0
CTRL_WRD4_ EVEN3	0x1020- W	cw63	cw62	cw61	cw60	cw59	cw58	cw57	cw56
		cw55	cw54	cw53	cw52	cw51	cw50	cw49	cw48
CTRL_WRD4_ EVEN2	0x1021- W	cw47	cw46	cw45	cw44	cw43	cw42	cw41	cw40
		cw39	cw38	cw37	cw36	cw35	cw34	cw33	cw32
CTRL_WRD4_ EVEN1	0x1022- W	cw31	cw30	cw29	cw28	cw27	cw26	cw25	cw24
		cw23	cw22	cw21	cw20	cw19	cw18	cw17	cw16
CTRL_WRD4_ EVEN0	0x1023- W	cw15	cw14	cw13	cw12	cw11	cw10	cw9	cw8
		cw7	cw6	cw5	cw4	cw3	cw2	cw1	cw0
CTRL_WRD4_ ODD3	0x1024- W	cw63	cw62	cw61	cw60	cw59	cw58	cw57	cw56
		cw55	cw54	cw53	cw52	cw51	cw50	cw49	cw48
CTRL_WRD4_ ODD2	0x1025- W	cw47	cw46	cw45	cw44	cw43	cw42	cw41	cw40
		cw39	cw38	cw37	cw36	cw35	cw34	cw33	cw32
CTRL_WRD4_ ODD1	0x1026- W	cw31	cw30	cw29	cw28	cw27	cw26	cw25	cw24
		cw23	cw22	cw21	cw20	cw19	cw18	cw17	cw16
CTRL_WRD4_ ODD0	0x1027- W	cw15	cw14	cw13	cw12	cw11	cw10	cw9	cw8
		cw7	cw6	cw5	cw4	cw3	cw2	cw1	cw0
CTRL_WRD5_ EVEN3	0x1028- W	cw63	cw62	cw61	cw60	cw59	cw58	cw57	cw56
		cw55	cw54	cw53	cw52	cw51	cw50	cw49	cw48
CTRL_WRD5_ EVEN2	0x1029- W	cw47	cw46	cw45	cw44	cw43	cw42	cw41	cw40
		cw39	cw38	cw37	cw36	cw35	cw34	cw33	cw32
CTRL_WRD5_ EVEN1	0x102A- W	cw31	cw30	cw29	cw28	cw27	cw26	cw25	cw24
		cw23	cw22	cw21	cw20	cw19	cw18	cw17	cw16
CTRL_WRD5_ EVEN0	0x102B- W	cw15	cw14	cw13	cw12	cw11	cw10	cw9	cw8
		cw7	cw6	cw5	cw4	cw3	cw2	cw1	cw0
CTRL_WRD5_ ODD3	0x102C- W	cw63	cw62	cw61	cw60	cw59	cw58	cw57	cw56
		cw55	cw54	cw53	cw52	cw51	cw50	cw49	cw48
CTRL_WRD5_ ODD2	0x102D- W	cw47	cw46	cw45	cw44	cw43	cw42	cw41	cw40
		cw39	cw38	cw37	cw36	cw35	cw34	cw33	cw32
CTRL_WRD5_ ODD1	0x102E- W	cw31	cw30	cw29	cw28	cw27	cw26	cw25	cw24
		cw23	cw22	cw21	cw20	cw19	cw18	cw17	cw16

DVB compliant descrambler

SAA7206H

REGISTER FUNCTION	ADDRESS (HEX)	BITS							
		15/7	14/6	13/5	12/4	11/3	10/2	9/1	8/0
CTRL_WRD5_ODD0	0x102F- $\bar{W}$	cw15	cw14	cw13	cw12	cw11	cw10	cw9	cw8
		cw7	cw6	cw5	cw4	cw3	cw2	cw1	cw0
DFLT_CTRL_WRD3	0x1030- $\bar{W}$	cw63	cw62	cw61	cw60	cw59	cw58	cw57	cw56
		cw55	cw54	cw53	cw52	cw51	cw50	cw49	cw48
DFLT_CTRL_WRD2	0x1031- $\bar{W}$	cw47	cw46	cw45	cw44	cw43	cw42	cw41	cw40
		cw39	cw38	cw37	cw36	cw35	cw34	cw33	cw32
DFLT_CTRL_WRD1	0x1032- $\bar{W}$	cw31	cw30	cw29	cw28	cw27	cw26	cw25	cw24
		cw23	cw22	cw21	cw20	cw19	cw18	cw17	cw16
DFLT_CTRL_WRD0	0x1033- $\bar{W}$	cw15	cw14	cw13	cw12	cw11	cw10	cw9	cw8
		cw7	cw6	cw5	cw4	cw3	cw2	cw1	cw0
EMPTY	0x1034 to 0x1FFF	-	-	-	-	-	-	-	-
		-	-	-	-	-	-	-	-
FLT0_BUFFER	0x2000 to 0x207F- R	data15	data14	data13	data12	data11	data10	data9	data8
		data7	data6	data5	data4	data3	data2	data1	data0
EMPTY	0x2080 to 0x20FF	-	-	-	-	-	-	-	-
		-	-	-	-	-	-	-	-
FLT1_BUFFER	0x2100 to 0x217F- R	data15	data14	data13	data12	data11	data10	data9	data8
		data7	data6	data5	data4	data3	data2	data1	data0
EMPTY	0x2180 to 0x21FF	-	-	-	-	-	-	-	-
		-	-	-	-	-	-	-	-
FLT2_BUFFER	0x2200 to 0x227F- R	data15	data14	data13	data12	data11	data10	data9	data8
		data7	data6	data5	data4	data3	data2	data1	data0
EMPTY	0x2280 to 0x22FF	-	-	-	-	-	-	-	-
		-	-	-	-	-	-	-	-
FLT3_BUFFER	0x2300 to 0x237F- R	data15	data14	data13	data12	data11	data10	data9	data8
		data7	data6	data5	data4	data3	data2	data1	data0
EMPTY	0x2380 to 0x23FF	-	-	-	-	-	-	-	-
		-	-	-	-	-	-	-	-
FLT4_BUFFER	0x2400 to 0x247F- R	data15	data14	data13	data12	data11	data10	data9	data8
		data7	data6	data5	data4	data3	data2	data1	data0
EMPTY	0x2380 to 0x23FF	-	-	-	-	-	-	-	-
		-	-	-	-	-	-	-	-

DVB compliant descrambler

SAA7206H

REGISTER FUNCTION	ADDRESS (HEX)	BITS							
		15/7	14/6	13/5	12/4	11/3	10/2	9/1	8/0
EMPTY	0x2480 to 0x24FF	-	-	-	-	-	-	-	-
		-	-	-	-	-	-	-	-
FLT5_BUFFER	0x2500 to 0x257F- R	data15	data14	data13	data12	data11	data10	data9	data8
		data7	data6	data5	data4	data3	data2	data1	data0
EMPTY	0x2580 to 0x25FF	-	-	-	-	-	-	-	-
		-	-	-	-	-	-	-	-
FLT6_BUFFER	0x2600 to 0x267F- R	data15	data14	data13	data12	data11	data10	data9	data8
		data7	data6	data5	data4	data3	data2	data1	data0
EMPTY	0x2680 to 0x26FF	-	-	-	-	-	-	-	-
		-	-	-	-	-	-	-	-
FLT7_BUFFER	0x2700 to 0x277F- R	data15	data14	data13	data12	data11	data10	data9	data8
		data7	data6	data5	data4	data3	data2	data1	data0
EMPTY	0x2780 to 0x27FF	-	-	-	-	-	-	-	-
		-	-	-	-	-	-	-	-
FLT8_BUFFER	0x2800 to 0x287F- R	data15	data14	data13	data12	data11	data10	data9	data8
		data7	data6	data5	data4	data3	data2	data1	data0
EMPTY	0x2880 to 0x28FF	-	-	-	-	-	-	-	-
		-	-	-	-	-	-	-	-
FLT9_BUFFER	0x2900 to 0x297F- R	data15	data14	data13	data12	data11	data10	data9	data8
		data7	data6	data5	data4	data3	data2	data1	data0
EMPTY	0x2980 to 0x29FF	-	-	-	-	-	-	-	-
		-	-	-	-	-	-	-	-
FLT10_BUFFER	0x2A00 - 0x2A7F- R	data15	data14	data13	data12	data11	data10	data9	data8
		data7	data6	data5	data4	data3	data2	data1	data0
EMPTY	0x2A80 to 0x2AFF	-	-	-	-	-	-	-	-
		-	-	-	-	-	-	-	-
FLT11_BUFFER	0x2B00 to 0x2B7F- R	data15	data14	data13	data12	data11	data10	data9	data8
		data7	data6	data5	data4	data3	data2	data1	data0
EMPTY	0x2B80 to 0x2BFF	-	-	-	-	-	-	-	-
		-	-	-	-	-	-	-	-



DVB compliant descrambler

SAA7206H

REGISTER FUNCTION	ADDRESS (HEX)	BITS							
		15/7	14/6	13/5	12/4	11/3	10/2	9/1	8/0
FLT12_BUFFER	0x2C00 to 0x2C7F- R	data15	data14	data13	data12	data11	data10	data9	data8
		data7	data6	data5	data4	data3	data2	data1	data0
EMPTY	0x2C80 to 0x2CFF	-	-	-	-	-	-	-	-
		-	-	-	-	-	-	-	-
FLT13_BUFFER	0x2D00 to 0x2D7F- R	data15	data14	data13	data12	data11	data10	data9	data8
		data7	data6	data5	data4	data3	data2	data1	data0
EMPTY	0x2D80 to 0x2DFF	-	-	-	-	-	-	-	-
		-	-	-	-	-	-	-	-
FLT14_BUFFER	0x2E00 to 0x2E7F- R	data15	data14	data13	data12	data11	data10	data9	data8
		data7	data6	data5	data4	data3	data2	data1	data0
EMPTY	0x2E80 to 0x2EFF	-	-	-	-	-	-	-	-
		-	-	-	-	-	-	-	-
FLT15_BUFFER	0x2F00 to 0x2F7F- R	data15	data14	data13	data12	data11	data10	data9	data8
		data7	data6	data5	data4	data3	data2	data1	data0
EMPTY	0x2F80 to 0x2FFF	-	-	-	-	-	-	-	-
		-	-	-	-	-	-	-	-
FLT16_BUFFER	0x3000 to 0x307F- R	data15	data14	data13	data12	data11	data10	data9	data8
		data7	data6	data5	data4	data3	data2	data1	data0
EMPTY	0x3080 to 0x30FF	-	-	-	-	-	-	-	-
		-	-	-	-	-	-	-	-
FLT17_BUFFER	0x3100 to 0x317F- R	data15	data14	data13	data12	data11	data10	data9	data8
		data7	data6	data5	data4	data3	data2	data1	data0
EMPTY	0x3180 to 0x3FFF	-	-	-	-	-	-	-	-
		-	-	-	-	-	-	-	-

## DVB compliant descrambler

## SAA7206H

**8 LIMITING VALUES**

In accordance with the Absolute Maximum Rating System (IEC 134).

SYMBOL	PARAMETER	MIN.	MAX.	UNIT
$V_{DDD(pads)}$	digital supply voltage for pads (+5 V)	-0.5	+6.5	V
$V_{DDD(core)}$	digital supply voltage for core (+3.3 V)	-0.5	+5.0	V
$V_I$	DC input voltage	-0.5	$V_{DDD} + 0.5$	V
$V_O$	DC output voltage;	-0.5	$V_{DDD} + 0.5$	V
$I_{DDD}, I_{SSD}$	DC current; $V_{DD}$ or $V_{SS}$	-	52	mA
$I_{i(max)}$	maximum input current	-10	+10	mA
$I_{o(max)}$	maximum output current	-20	+20	mA
$P_{tot}$	total power dissipation	-	250	mW
$T_{stg}$	storage temperature	-65	+150	°C
$T_{amb}$	operating ambient temperature	0	70	°C

**9 HANDLING**

Inputs and outputs are protected against electrostatic discharges in normal handling. However, to be totally safe, it is desirable to take normal precautions appropriate to handling integrated circuits.

Every pin withstands the ESD test in accordance with "UZW-BO/FQ-B3020", 0  $\Omega$ , 200 pF Machine Model (300 V).

**10 THERMAL CHARACTERISTICS**

SYMBOL	PARAMETER	CONDITIONS	VALUE	UNIT
$R_{th j-a}$	thermal resistance from junction to ambient	in free air	56	K/W

**11 DC CHARACTERISTICS**

$V_{DDD(core)} = 3.3 \text{ V} \pm 0.3 \text{ V}$ ;  $V_{DDD} = 5 \text{ V} \pm 0.5 \text{ V}$ ;  $T_{amb} = 0 \text{ to } 70 \text{ }^\circ\text{C}$ ; unless otherwise specified.

SYMBOL	PARAMETER	CONDITIONS	MIN.	MAX.	UNIT
$I_{DDD(q)}$	quiescent supply current	$V_{DDD} = 5.5 \text{ V}$ ; note 1	-	100	$\mu\text{A}$
$I_{DDD(core)}$	digital operating current for core	$V_{DDD} = 5.5 \text{ V}$ ; $V_{DDD(core)} = 3.6 \text{ V}$ ; note 2	-	42	mA
$I_{DDD(pads)}$	digital operating current for pads	$V_{DDD} = 5.5 \text{ V}$ ; $V_{DDD(core)} = 3.6 \text{ V}$ ; note 2	-	10	mA
$V_{IL}$	LOW level input voltage		0	0.8	V
$V_{IH}$	HIGH level input voltage		2.0	$V_{DDD}$	V
$I_{LI}$	input leakage current	$V_i = 0 \text{ V}$ ; $T_{amb} = 25 \text{ }^\circ\text{C}$	-	10	$\mu\text{A}$
		$V_i = 5.5 \text{ V}$ ; $T_{amb} = 25 \text{ }^\circ\text{C}$	-	10	$\mu\text{A}$
$V_{OL}$	LOW level output voltage	$I_o = 4 \text{ mA}$	0	$0.1V_{DDD}$	V
$V_{OH}$	HIGH level output voltage	$I_o = 4 \text{ mA}$	$0.9V_{DDD}$	$V_{DDD}$	V

**Notes**

- All inputs at  $V_{SSD}$  or  $V_{DDD}$ .
- Operating inputs, unloaded outputs.

## DVB compliant descrambler

## SAA7206H

**12 AC CHARACTERISTICS**

$V_{DD(core)} = 3.3\text{ V} \pm 0.3\text{ V}$ ;  $V_{DD} = 5\text{ V} \pm 0.5\text{ V}$ ;  $T_{amb} = 0\text{ to }70\text{ }^{\circ}\text{C}$ ; unless otherwise specified.

SYMBOL	PARAMETER	CONDITIONS	MIN.	MAX.	UNIT
<b>Input interface; (see Fig.12)</b>					
$C_i$	input capacitance		–	5	pF
$T_{cy}$	byte strobe input cycle time (asynchronous mode)	note 1	111	–	ns
$t_{i(r)(CLK)}$	input clock rise time		–	10	ns
$t_{i(f)(CLK)}$	input clock fall time		–	10	ns
$t_{CLKH}$	input clock HIGH time		20	–	ns
$t_{CLKL}$	input clock LOW time		20	–	ns
$t_{i(r)}$	input rise time		–	10	ns
$t_{i(f)}$	input fall time		–	10	ns
$t_{su(i)}$	input set-up time		15	–	ns
$t_{h(i)}$	input hold time		5	–	ns
<b>Microcontroller interface</b>					
$C_i$	input capacitance		–	5	pF
$T_{cy(CS)}$	chip select cycle time	see also Fig.9	111	–	ns
$t_{r(CS)}$	chip select rise time		–	10	ns
$t_{f(CS)}$	chip select fall time		–	10	ns
$t_{CSH}$	chip select HIGH time		20	–	ns
$t_{CSL}$	chip select LOW time		20	–	ns
<b>WRITE CYCLE; (see Figs 14 and 15)</b>					
$t_{i(r)}$	input rise time		–	10	ns
$t_{i(f)}$	input fall time		–	10	ns
$t_{su(i)}$	input set-up time		15	–	ns
$t_{h(i)}$	input hold time		5	–	ns
<b>READ CYCLE; (see Fig.16)</b>					
$t_{CSLr}$	chip select LOW time in read mode		240	–	ns
$t_{o(r)}$	output rise time		–	10	ns
$t_{o(f)}$	output fall time		–	10	ns
$t_{o(d)}$	output delay time		–	30	ns
$t_{o(h)}$	output hold time		5	–	ns
$t_{oL(Z)}$	output low Z time	note 2	3	30	ns
$t_{oH(Z)}$	output high Z time	note 2	3	30	ns

## DVB compliant descrambler

## SAA7206H

SYMBOL	PARAMETER	CONDITIONS	MIN.	MAX.	UNIT
<b>Output interface; (see Fig.13)</b>					
$C_o$	output capacitance		–	10	pF
$C_L$	output load capacitance		–	50	pF
$T_{cy}(DCLK)$	output clock cycle time (DCLK)		111	–	ns
$t_{o(r)}(DCLK)$	output clock rise time		–	10	ns
$t_{o(f)}(DCLK)$	output clock fall time		–	10	ns
$t_{DCLKH}$	output clock HIGH time		20	–	ns
$t_{DCLKL}$	output clock LOW time		20	–	ns
$t_{o(r)}$	output rise time		–	10	ns
$t_{o(f)}$	output fall time		–	10	ns
$t_{o(h)}$	output hold time	$C_L = 5 \text{ pF}$	3	–	ns
$t_{o(d)}$	output delay time	$C_L = 30 \text{ pF}$	–	40	ns

**Notes**

1. In the synchronous mode all input signals are referenced to the descrambler clock which is specified in the output interface part. In the asynchronous mode all input signals are referenced to the MBCLK.
2. Data output is low impedance when both  $(\overline{DCS} = 0)$  AND  $(R/\overline{W} = 1)$ .  $t_{oL(Z)}$  is defined after the last change of both signals which makes the data output low impedance.  $t_{oH(Z)}$  is defined after the first change of both signals which makes the data output high impedance.

DVB compliant descrambler

SAA7206H

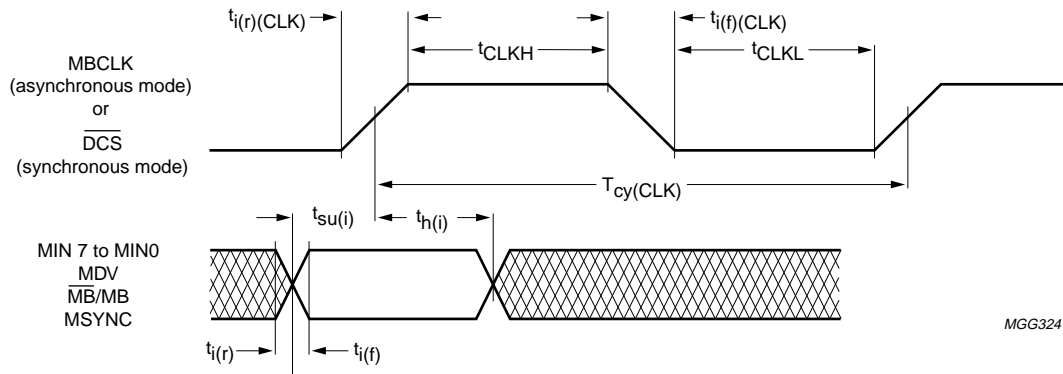

MGG324

Fig.12 Timing definition of the input interface signals.

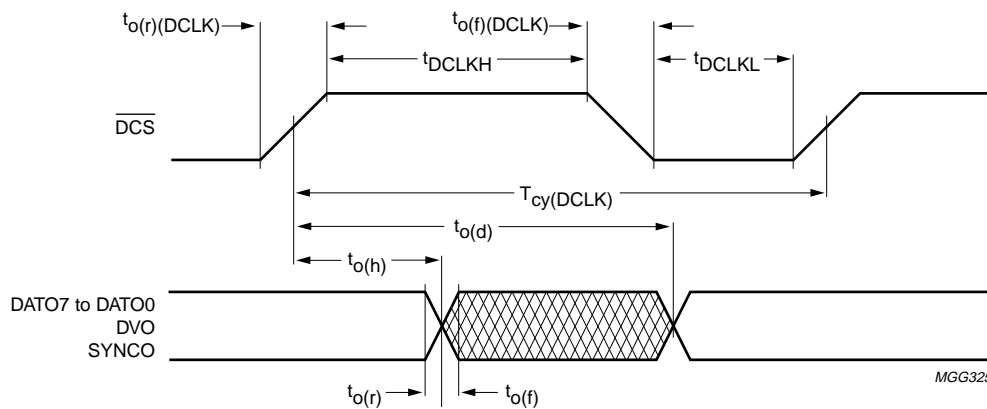

MGG325

Fig.13 Timing definition of the output interface signals.

DVB compliant descrambler

SAA7206H

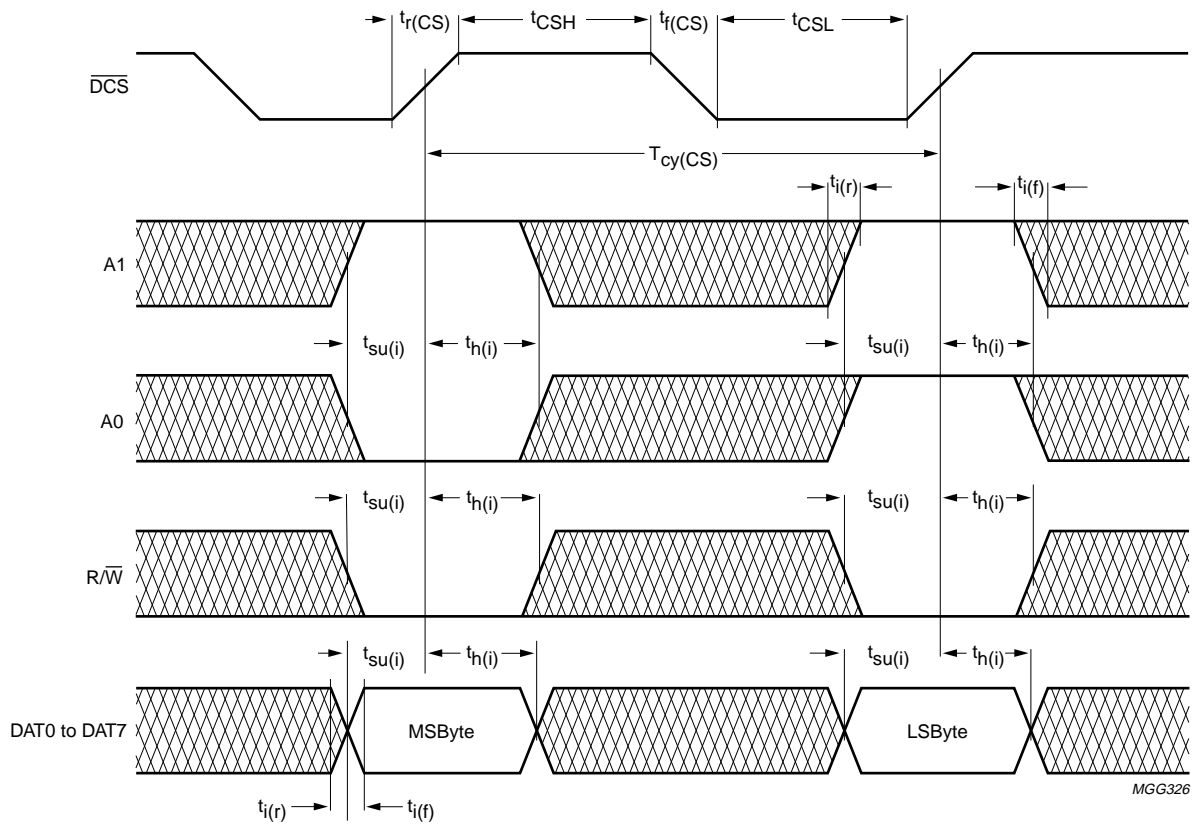

Fig.14 Timing definition of the microcontroller interface signals (address write cycle).

DVB compliant descrambler

SAA7206H

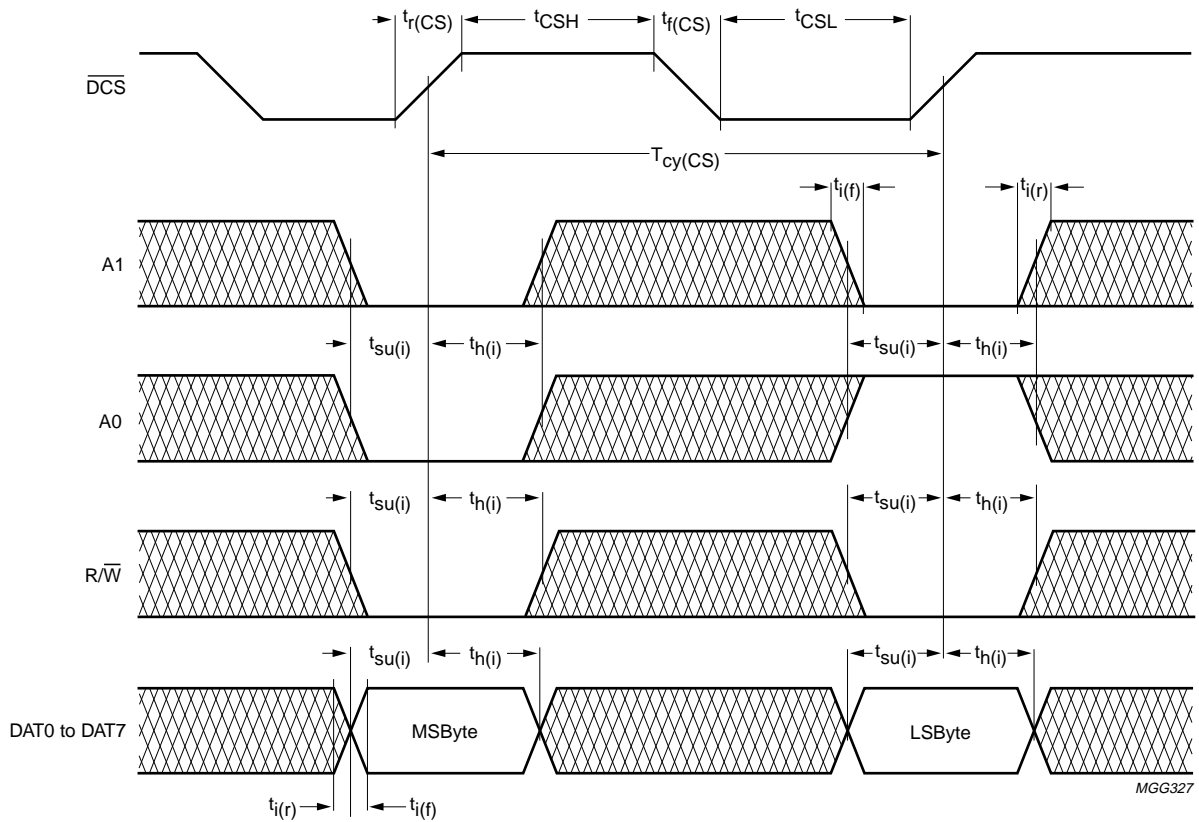

Fig.15 Timing definition of the microcontroller interface signals (data write cycle).

DVB compliant descrambler

SAA7206H

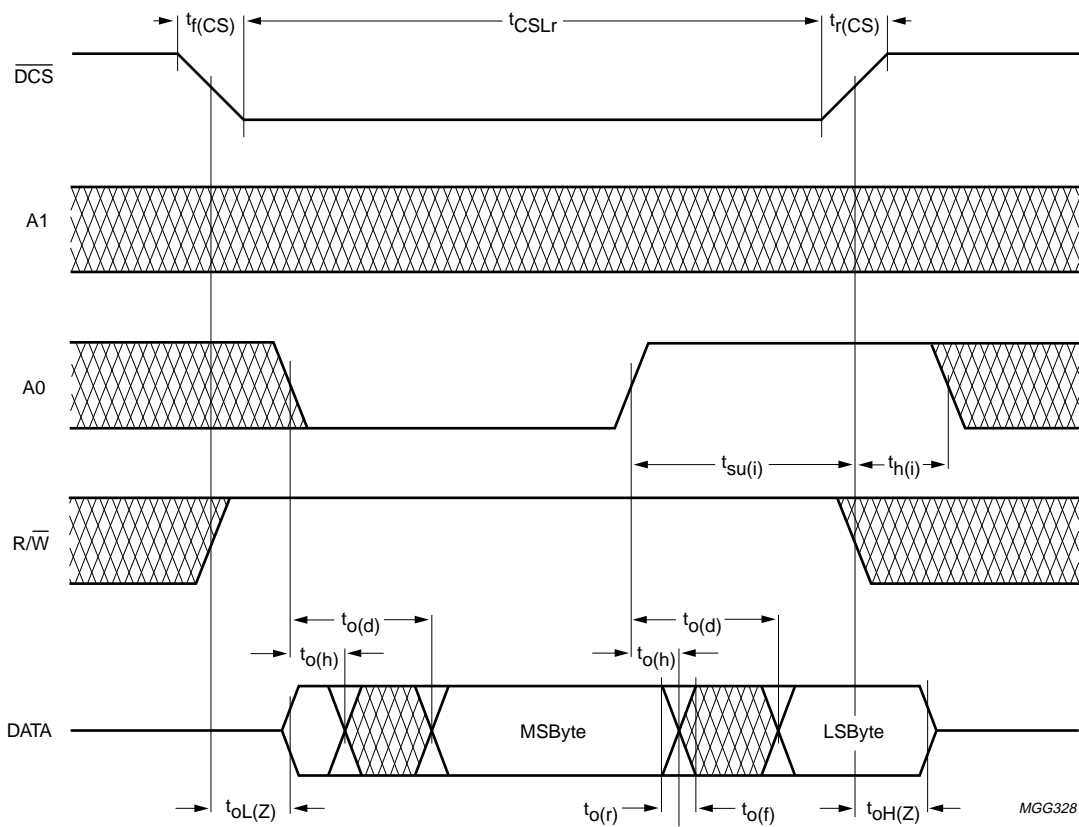

Fig.16 Timing definition of the microcontroller interface signals (read cycle).



DVB compliant descrambler

SAA7206H

13 PACKAGE OUTLINE

QFP64: plastic quad flat package; 64 leads (lead length 1.95 mm); body 14 x 20 x 2.8 mm

SOT319-2

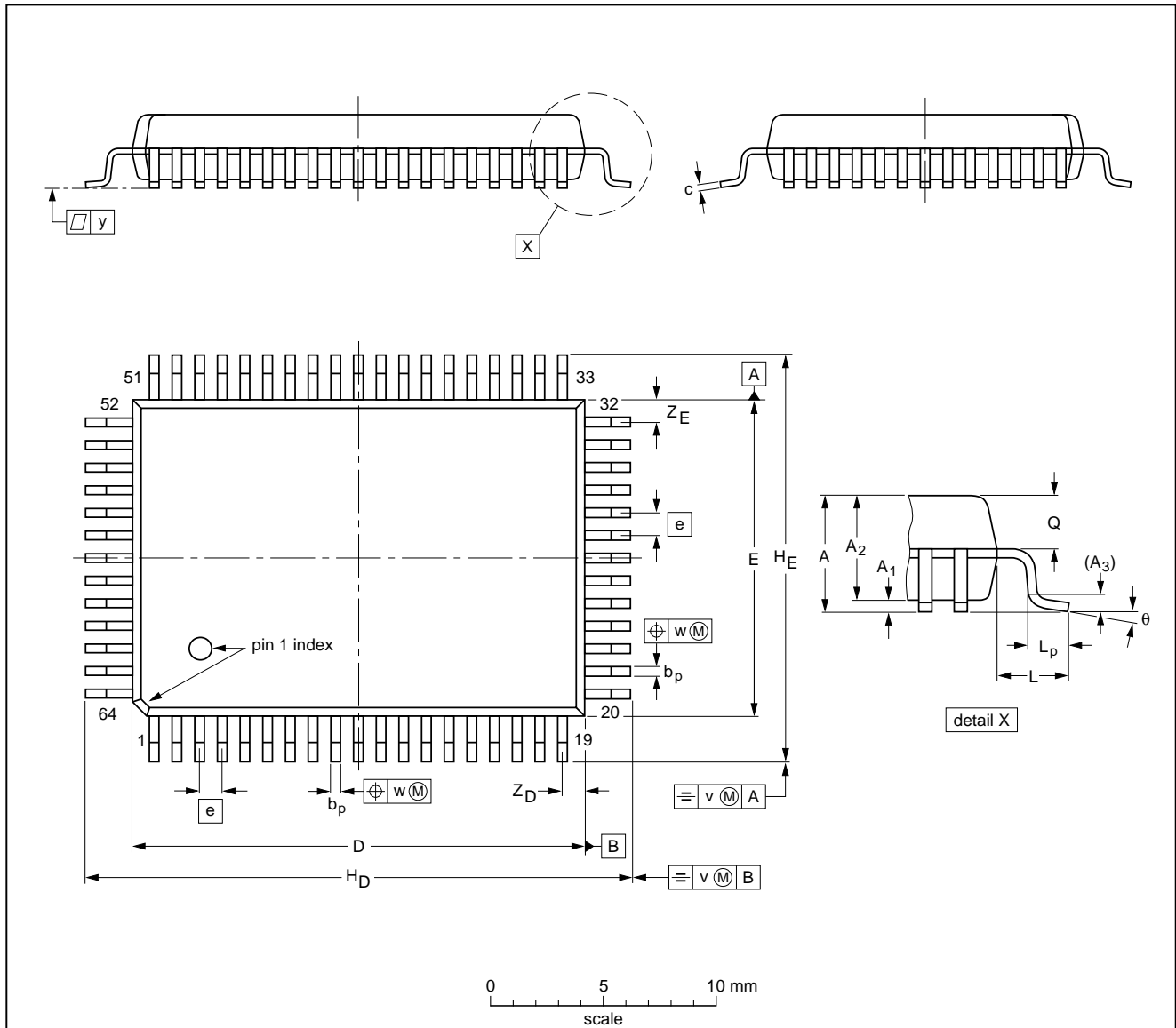

DIMENSIONS (mm are the original dimensions)

UNIT	A max.	A <sub>1</sub>	A <sub>2</sub>	A <sub>3</sub>	b <sub>p</sub>	c	D <sup>(1)</sup>	E <sup>(1)</sup>	e	H <sub>D</sub>	H <sub>E</sub>	L	L <sub>p</sub>	Q	v	w	y	Z <sub>D</sub> <sup>(1)</sup>	Z <sub>E</sub> <sup>(1)</sup>	θ
mm	3.20	0.25 0.05	2.90 2.65	0.25	0.50 0.35	0.25 0.14	20.1 19.9	14.1 13.9	1	24.2 23.6	18.2 17.6	1.95	1.0 0.6	1.4 1.2	0.2	0.2	0.1	1.2 0.8	1.2 0.8	7° 0°

Note

1. Plastic or metal protrusions of 0.25 mm maximum per side are not included.

OUTLINE VERSION	REFERENCES				EUROPEAN PROJECTION	ISSUE DATE
	IEC	JEDEC	EIAJ			
SOT319-2						92-11-17 95-02-04

## DVB compliant descrambler

## SAA7206H

### 14 SOLDERING

#### 14.1 Introduction

There is no soldering method that is ideal for all IC packages. Wave soldering is often preferred when through-hole and surface mounted components are mixed on one printed-circuit board. However, wave soldering is not always suitable for surface mounted ICs, or for printed-circuits with high population densities. In these situations reflow soldering is often used.

This text gives a very brief insight to a complex technology. A more in-depth account of soldering ICs can be found in our "IC Package Databook" (order code 9398 652 90011).

#### 14.2 Reflow soldering

Reflow soldering techniques are suitable for all QFP and SO packages.

The choice of heating method may be influenced by larger plastic QFP packages (44 leads, or more). If infrared or vapour phase heating is used and the large packages are not absolutely dry (less than 0.1% moisture content by weight), vaporization of the small amount of moisture in them can cause cracking of the plastic body. For more information, refer to the Drypack chapter in our "Quality Reference Manual" (order code 9397 750 00192).

Reflow soldering requires solder paste (a suspension of fine solder particles, flux and binding agent) to be applied to the printed-circuit board by screen printing, stencilling or pressure-syringe dispensing before package placement.

Several techniques exist for reflowing; for example, thermal conduction by heated belt. Dwell times vary between 50 and 300 seconds depending on heating method. Typical reflow temperatures range from 215 to 250 °C.

Preheating is necessary to dry the paste and evaporate the binding agent. Preheating duration: 45 minutes at 45 °C.

#### 14.3 Wave soldering

##### 14.3.1 QFP

Wave soldering is **not** recommended for QFP packages. This is because of the likelihood of solder bridging due to closely-spaced leads and the possibility of incomplete solder penetration in multi-lead devices.

If wave soldering cannot be avoided, the following conditions must be observed:

- A double-wave (a turbulent wave with high upward pressure followed by a smooth laminar wave) soldering technique should be used.
- The footprint must be at an angle of 45° to the board direction and must incorporate solder thieves downstream and at the side corners.

Even with these conditions, do not consider wave soldering the following packages: QFP52 (SOT379-1), QFP100 (SOT317-1), QFP100 (SOT317-2), QFP100 (SOT382-1) or QFP160 (SOT322-1).

##### 14.3.2 SO

Wave soldering techniques can be used for all SO packages if the following conditions are observed:

- A double-wave (a turbulent wave with high upward pressure followed by a smooth laminar wave) soldering technique should be used.
- The longitudinal axis of the package footprint must be parallel to the solder flow.
- The package footprint must incorporate solder thieves at the downstream end.

##### 14.3.3 METHOD (QFP AND SO)

During placement and before soldering, the package must be fixed with a droplet of adhesive. The adhesive can be applied by screen printing, pin transfer or syringe dispensing. The package can be soldered after the adhesive is cured.

Maximum permissible solder temperature is 260 °C, and maximum duration of package immersion in solder is 10 seconds, if cooled to less than 150 °C within 6 seconds. Typical dwell time is 4 seconds at 250 °C.

A mildly-activated flux will eliminate the need for removal of corrosive residues in most applications.

#### 14.4 Repairing soldered joints

Fix the component by first soldering two diagonally-opposite end leads. Use only a low voltage soldering iron (less than 24 V) applied to the flat part of the lead. Contact time must be limited to 10 seconds at up to 300 °C. When using a dedicated tool, all other leads can be soldered in one operation within 2 to 5 seconds between 270 and 320 °C.

## DVB compliant descrambler

SAA7206H

**15 DEFINITIONS**

<b>Data sheet status</b>	
Objective specification	This data sheet contains target or goal specifications for product development.
Preliminary specification	This data sheet contains preliminary data; supplementary data may be published later.
Product specification	This data sheet contains final product specifications.
<b>Limiting values</b>	
Limiting values given are in accordance with the Absolute Maximum Rating System (IEC 134). Stress above one or more of the limiting values may cause permanent damage to the device. These are stress ratings only and operation of the device at these or at any other conditions above those given in the Characteristics sections of the specification is not implied. Exposure to limiting values for extended periods may affect device reliability.	
<b>Application information</b>	
Where application information is given, it is advisory and does not form part of the specification.	

**16 LIFE SUPPORT APPLICATIONS**

These products are not designed for use in life support appliances, devices, or systems where malfunction of these products can reasonably be expected to result in personal injury. Philips customers using or selling these products for use in such applications do so at their own risk and agree to fully indemnify Philips for any damages resulting from such improper use or sale.

# Philips Semiconductors – a worldwide company

**Argentina:** see South America

**Australia:** 34 Waterloo Road, NORTH RYDE, NSW 2113,  
Tel. +61 2 9805 4455, Fax. +61 2 9805 4466

**Austria:** Computerstr. 6, A-1101 WIEN, P.O. Box 213,  
Tel. +43 1 60 101, Fax. +43 1 60 101 1210

**Belarus:** Hotel Minsk Business Center, Bld. 3, r. 1211, Volodarski Str. 6,  
220050 MINSK, Tel. +375 172 200 733, Fax. +375 172 200 773

**Belgium:** see The Netherlands

**Brazil:** see South America

**Bulgaria:** Philips Bulgaria Ltd., Energoproject, 15th floor,  
51 James Bourchier Blvd., 1407 SOFIA,  
Tel. +359 2 689 211, Fax. +359 2 689 102

**Canada:** PHILIPS SEMICONDUCTORS/COMPONENTS,  
Tel. +1 800 234 7381

**China/Hong Kong:** 501 Hong Kong Industrial Technology Centre,  
72 Tat Chee Avenue, Kowloon Tong, HONG KONG,  
Tel. +852 2319 7888, Fax. +852 2319 7700

**Colombia:** see South America

**Czech Republic:** see Austria

**Denmark:** Prags Boulevard 80, PB 1919, DK-2300 COPENHAGEN S,  
Tel. +45 32 88 2636, Fax. +45 31 57 1949

**Finland:** Sinikalliontie 3, FIN-02630 ESPOO,  
Tel. +358 9 615800, Fax. +358 9 61580/xxx

**France:** 4 Rue du Port-aux-Vins, BP317, 92156 SURESNES Cedex,  
Tel. +33 1 40 99 6161, Fax. +33 1 40 99 6427

**Germany:** Hammerbrookstraße 69, D-20097 HAMBURG,  
Tel. +49 40 23 53 60, Fax. +49 40 23 536 300

**Greece:** No. 15, 25th March Street, GR 17778 TAVROS/ATHENS,  
Tel. +30 1 4894 339/239, Fax. +30 1 4814 240

**Hungary:** see Austria

**India:** Philips INDIA Ltd, Shivsagar Estate, A Block, Dr. Annie Besant Rd.  
Worli, MUMBAI 400 018, Tel. +91 22 4938 541, Fax. +91 22 4938 722

**Indonesia:** see Singapore

**Ireland:** Newstead, Clonskeagh, DUBLIN 14,  
Tel. +353 1 7640 000, Fax. +353 1 7640 200

**Israel:** RAPAC Electronics, 7 Kehilat Saloniki St, TEL AVIV 61180,  
Tel. +972 3 645 0444, Fax. +972 3 649 1007

**Italy:** PHILIPS SEMICONDUCTORS, Piazza IV Novembre 3,  
20124 MILANO, Tel. +39 2 6752 2531, Fax. +39 2 6752 2557

**Japan:** Philips Bldg 13-37, Kohnan 2-chome, Minato-ku, TOKYO 108,  
Tel. +81 3 3740 5130, Fax. +81 3 3740 5077

**Korea:** Philips House, 260-199 Itaewon-dong, Yongsan-ku, SEOUL,  
Tel. +82 2 709 1412, Fax. +82 2 709 1415

**Malaysia:** No. 76 Jalan Universiti, 46200 PETALING JAYA, SELANGOR,  
Tel. +60 3 750 5214, Fax. +60 3 757 4880

**Mexico:** 5900 Gateway East, Suite 200, EL PASO, TEXAS 79905,  
Tel. +9-5 800 234 7381

**Middle East:** see Italy

**Netherlands:** Postbus 90050, 5600 PB EINDHOVEN, Bldg. VB,  
Tel. +31 40 27 82785, Fax. +31 40 27 88399

**New Zealand:** 2 Wagener Place, C.P.O. Box 1041, AUCKLAND,  
Tel. +64 9 849 4160, Fax. +64 9 849 7811

**Norway:** Box 1, Manglerud 0612, OSLO,  
Tel. +47 22 74 8000, Fax. +47 22 74 8341

**Philippines:** Philips Semiconductors Philippines Inc.,  
106 Valero St. Salcedo Village, P.O. Box 2108 MCC, MAKATI,  
Metro MANILA, Tel. +63 2 816 6380, Fax. +63 2 817 3474

**Poland:** Ul. Lukiska 10, PL 04-123 WARSZAWA,  
Tel. +48 22 612 2831, Fax. +48 22 612 2327

**Portugal:** see Spain

**Romania:** see Italy

**Russia:** Philips Russia, Ul. Usatcheva 35A, 119048 MOSCOW,  
Tel. +7 095 247 9145, Fax. +7 095 247 9144

**Singapore:** Lorong 1, Toa Payoh, SINGAPORE 1231,  
Tel. +65 350 2538, Fax. +65 251 6500

**Slovakia:** see Austria

**Slovenia:** see Italy

**South Africa:** S.A. PHILIPS Pty Ltd., 195-215 Main Road Martindale,  
2092 JOHANNESBURG, P.O. Box 7430 Johannesburg 2000,  
Tel. +27 11 470 5911, Fax. +27 11 470 5494

**South America:** Rua do Rocio 220, 5th floor, Suite 51,  
04552-903 São Paulo, SÃO PAULO - SP, Brazil,  
Tel. +55 11 821 2333, Fax. +55 11 829 1849

**Spain:** Balmes 22, 08007 BARCELONA,  
Tel. +34 3 301 6312, Fax. +34 3 301 4107

**Sweden:** Kottbygatan 7, Akalla, S-16485 STOCKHOLM,  
Tel. +46 8 632 2000, Fax. +46 8 632 2745

**Switzerland:** Allmendstrasse 140, CH-8027 ZÜRICH,  
Tel. +41 1 488 2686, Fax. +41 1 481 7730

**Taiwan:** PHILIPS TAIWAN Ltd., 23-30F, 66,  
Chung Hsiao West Road, Sec. 1, P.O. Box 22978,  
TAIPEI 100, Tel. +886 2 382 4443, Fax. +886 2 382 4444

**Thailand:** PHILIPS ELECTRONICS (THAILAND) Ltd.,  
209/2 Sanpavuth-Bangna Road Prakanong, BANGKOK 10260,  
Tel. +66 2 745 4090, Fax. +66 2 398 0793

**Turkey:** Talatpasa Cad. No. 5, 80640 GÜLTEPE/ISTANBUL,  
Tel. +90 212 279 2770, Fax. +90 212 282 6707

**Ukraine:** PHILIPS UKRAINE, 4 Patrice Lumumba str., Building B, Floor 7,  
252042 KIEV, Tel. +380 44 264 2776, Fax. +380 44 268 0461

**United Kingdom:** Philips Semiconductors Ltd., 276 Bath Road, Hayes,  
MIDDLESEX UB3 5BX, Tel. +44 181 730 5000, Fax. +44 181 754 8421

**United States:** 811 East Arques Avenue, SUNNYVALE, CA 94088-3409,  
Tel. +1 800 234 7381

**Uruguay:** see South America

**Vietnam:** see Singapore

**Yugoslavia:** PHILIPS, Trg N. Pasica 5/v, 11000 BEOGRAD,  
Tel. +381 11 625 344, Fax. +381 11 635 777

**For all other countries apply to:** Philips Semiconductors, Marketing & Sales Communications,  
Building BE-p, P.O. Box 218, 5600 MD EINDHOVEN, The Netherlands, Fax. +31 40 27 24825

**Internet:** <http://www.semiconductors.philips.com>

© Philips Electronics N.V. 1996

SCA52

All rights are reserved. Reproduction in whole or in part is prohibited without the prior written consent of the copyright owner.

The information presented in this document does not form part of any quotation or contract, is believed to be accurate and reliable and may be changed without notice. No liability will be accepted by the publisher for any consequence of its use. Publication thereof does not convey nor imply any license under patent- or other industrial or intellectual property rights.

Printed in The Netherlands

537021/1200/02/pp52

Date of release: 1996 Oct 09

Document order number: 9397 750 01331

*Let's make things better.*

**Philips**  
Semiconductors



**PHILIPS**