

High Efficiency Snubber Diode

Features and Benefits

- High Peak Reverse Voltage, V_{RM} : 800 V
- Low Forward Voltage, V_F : 0.92 V (max.) at $I_F = 1.5$ A
- Peak Forward Surge Current, I_{FSM} : 100 A
- Average Forward Current, $I_{F(AV)}$: 1.2 A
- Flammability rating UL94V-0 (Equivalent)
- Pins Pb (lead) free

Package: Axial



Description

The SARS02 is an 800 V silicon diode designed especially for use in high-efficiency snubber circuits. This diode can sustain a high voltage with low loss, with low-noise rectification.

To suppress surge voltage, conduct the surge voltage and noise into a capacitor via a series resistor, R_S . Then allow the capacitor to discharge the energy into power supply line with the regenerative circuit operation, shown below in the typical application circuit schematic.

Applications

- White goods appliances
- Audio-visual equipment
- Light fixtures
- Communication equipment
- Factory automation

Product Structure

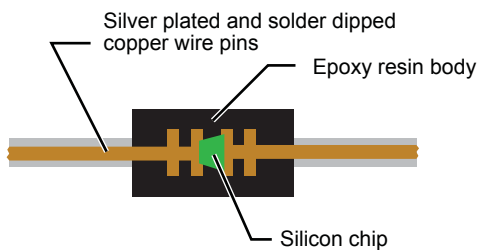

Typical Application

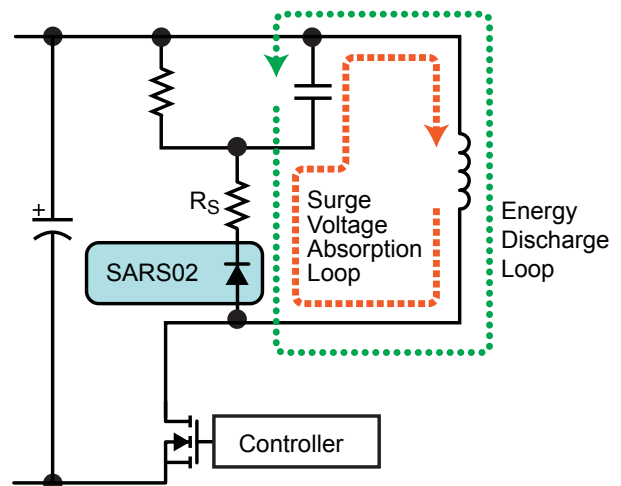

Selection Guide

Part Number	Packing*
SARS02	1000 pieces per box, bulk
SARS02V	3000 pieces per reel, 52 mm pitch axial taping
SARS02V1	1000 pieces per box, 52 mm pitch axial taping

*See the Packing Options page for details on the packing orientation.

Absolute Maximum Ratings

Characteristic	Symbol	Conditions	Rating	Unit
Peak Reverse Surge Voltage	V_{RSM}		800	V
Peak Reverse Voltage	V_{RM}		800	V
Average Forward Current	$I_{F(AV)}$	Refer to figure 1	1.2	A
Peak Forward Surge Current	I_{FSM}	10 ms, half sine wave, one shot	100	A
I^2t Limiting Value	I^2t	1 ms < t < 10 ms	50	A ² ·s
Junction Temperature	T_j		-40 to 150	°C
Storage Temperature	T_{stg}		-40 to 150	°C

Design Notes

Use a series resistor (R_S in the typical application circuit schematic), and choose a value for the resistor such that the SARS02 diode saturates at junction temperature, $T_j \leq 150^\circ\text{C}$.

Electrical Characteristics valid at $T_A = 25^\circ\text{C}$, unless otherwise specified

Characteristic	Symbol	Test Conditions	Value	Unit
Forward Voltage	V_F	$I_F = 1.5\text{ A}$	0.92 (max)	V
Reverse Current	I_R	$V_R = V_{RM}$	10 (max)	μA
Reverse Current (High Temperature)	$I_{R(H)}$	$V_R = V_{RM}, T_J = 100^\circ\text{C}$	50 (max)	μA
Reverse Recovery Time	t_{rr}	$I_F = I_{RP} = 10\text{ mA}$, 90% recovery point, $T_J = 25^\circ\text{C}$	2.0 to 18	μs
Thermal Resistance, Junction to Lead	$R_{\theta JL}$	Between junction and pin	15 (max)	$^\circ\text{C/W}$

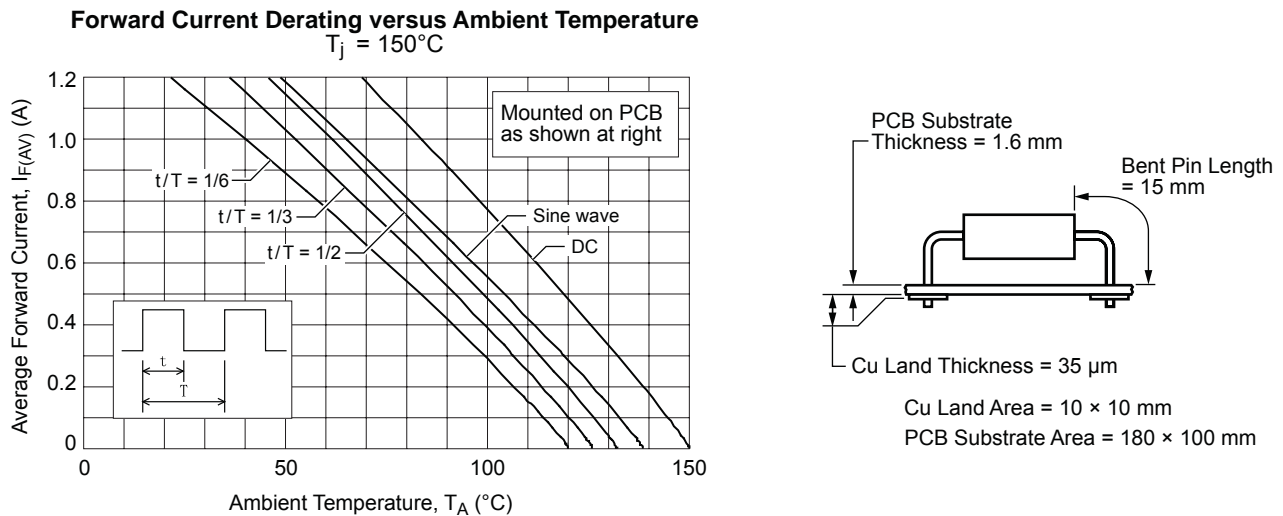

Figure 1. Derating Characteristics and Mounting Conditions

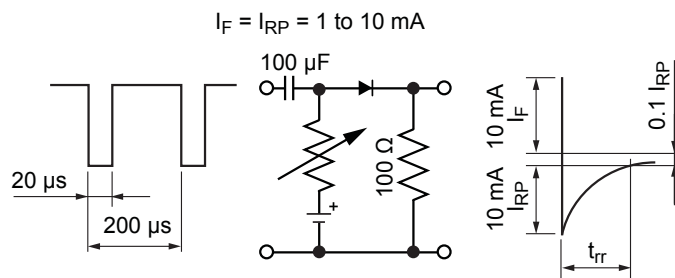
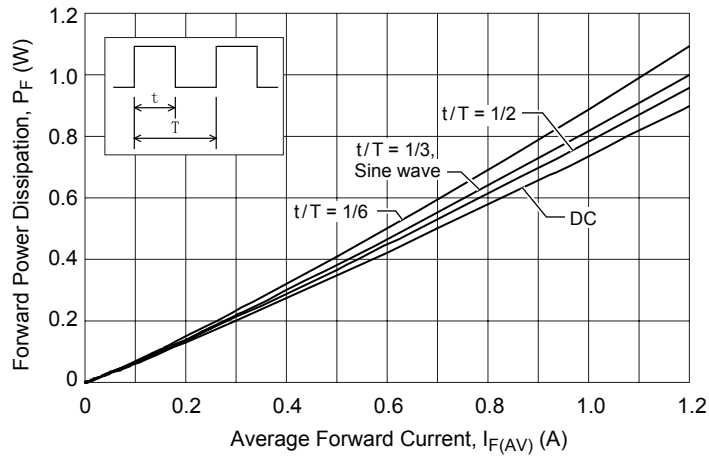

Figure 2. Definition of Peak Reverse Current, I_{RP}

Characteristic Performance

Forward Power Dissipation versus Average Forward Current
 $T_j = 150^\circ\text{C}$



Reverse Power Dissipation versus Reverse Voltage
 $T_j = 150^\circ\text{C}$

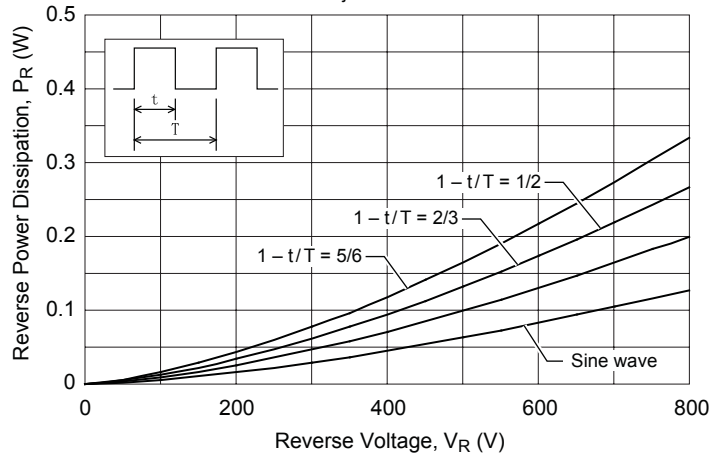

Package Outline

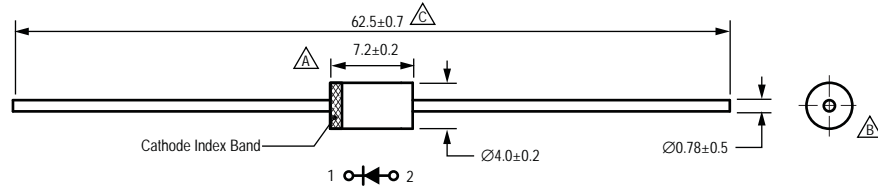

- Dimensions in mm
- Offset body centerline to pin centerline 0.5 mm maximum
 - Concentricity body and pin 0.3 mm maximum
 - Pin dimension does not include trim burr; burr 2 mm maximum

Package Marking

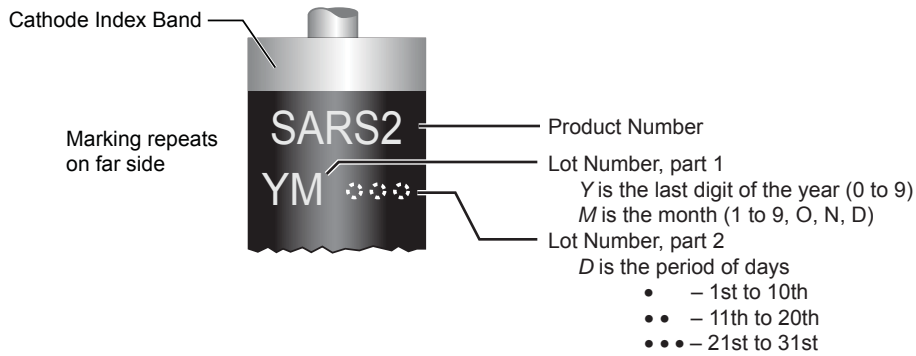

Material Composition and Internal Structure

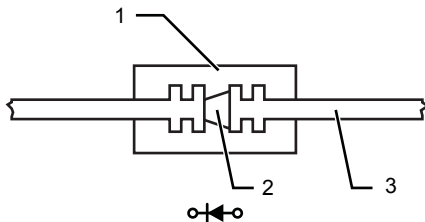

- 1. Body: Plastic, epoxy resin
 - 2. Chip: Si
 - 3. Pins: Cu wire
Ag plating
Solder dipped
- Weight: Approximately 0.4 g



Pin treatment Pb-free. Device composition compliant with the RoHS directive.

Packing Options

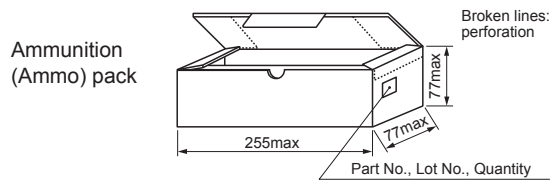
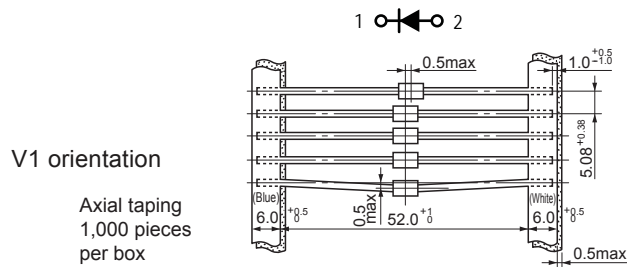
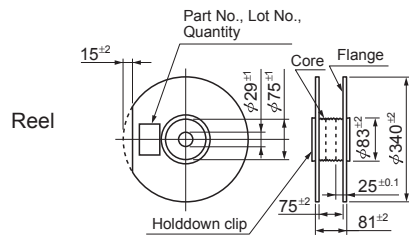
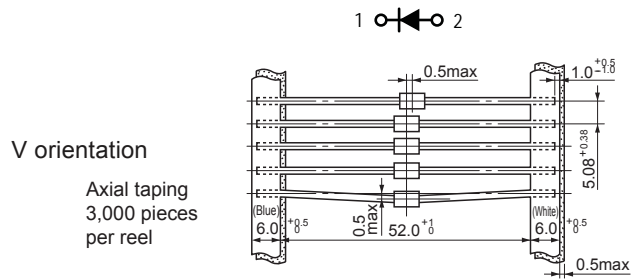

Dimensions in mm

-
- The contents in this document are subject to changes, for improvement and other purposes, without notice. Make sure that this is the latest revision of the document before use.
 - Application and operation examples described in this document are quoted for the sole purpose of reference for the use of the products herein and Sanken can assume no responsibility for any infringement of industrial property rights, intellectual property rights or any other rights of Sanken or any third party which may result from its use.
 - Although Sanken undertakes to enhance the quality and reliability of its products, the occurrence of failure and defect of semiconductor products at a certain rate is inevitable. Users of Sanken products are requested to take, at their own risk, preventative measures including safety design of the equipment or systems against any possible injury, death, fires or damages to the society due to device failure or malfunction.
 - Sanken products listed in this document are designed and intended for the use as components in general purpose electronic equipment or apparatus (home appliances, office equipment, telecommunication equipment, measuring equipment, etc.).

When considering the use of Sanken products in the applications where higher reliability is required (transportation equipment and its control systems, traffic signal control systems or equipment, fire/crime alarm systems, various safety devices, etc.), and whenever long life expectancy is required even in general purpose electronic equipment or apparatus, please contact your nearest Sanken sales representative to discuss, prior to the use of the products herein.

The use of Sanken products without the written consent of Sanken in the applications where extremely high reliability is required (aerospace equipment, nuclear power control systems, life support systems, etc.) is strictly prohibited.

- In the case that you use Sanken products or design your products by using Sanken products, the reliability largely depends on the degree of derating to be made to the rated values. Derating may be interpreted as a case that an operation range is set by derating the load from each rated value or surge voltage or noise is considered for derating in order to assure or improve the reliability. In general, derating factors include electric stresses such as electric voltage, electric current, electric power etc., environmental stresses such as ambient temperature, humidity etc. and thermal stress caused due to self-heating of semiconductor products. For these stresses, instantaneous values, maximum values and minimum values must be taken into consideration.

In addition, it should be noted that since power devices or IC's including power devices have large self-heating value, the degree of derating of junction temperature affects the reliability significantly.

- When using the products specified herein by either (i) combining other products or materials therewith or (ii) physically, chemically or otherwise processing or treating the products, please duly consider all possible risks that may result from all such uses in advance and proceed therewith at your own responsibility.
- Anti radioactive ray design is not considered for the products listed herein.
- Sanken assumes no responsibility for any troubles, such as dropping products caused during transportation out of Sanken's distribution network.
- The contents in this document must not be transcribed or copied without Sanken's written consent.