

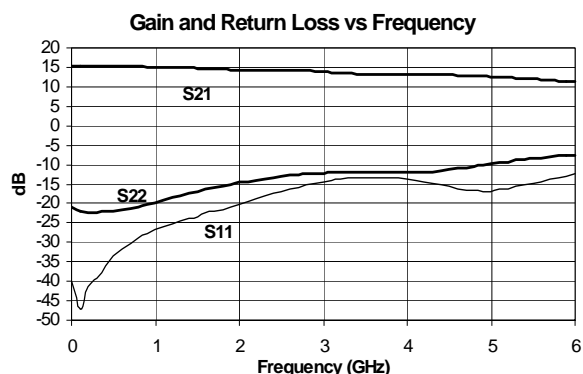

## Product Description

Sirenza Microdevices' SBA-4089 is a high performance InGaP/GaAs Heterojunction Bipolar Transistor MMIC Amplifier. A Darlington configuration designed with InGaP process technology provides broadband performance up to 5 GHz with excellent thermal performance. The heterojunction increases breakdown voltage and minimizes leakage current between junctions. Cancellation of emitter junction non-linearities results in higher suppression of intermodulation products. Only a single positive supply voltage, DC-blocking capacitors, a bias resistor, and an optional RF choke are required for operation.

The matte tin finish on Sirenza's lead-free package utilizes a post annealing process to mitigate tin whisker formation and is RoHS compliant per EU Directive 2002/95. This package is also manufactured with green molding compounds that contain no anti-mony trioxide nor halogenated fire retardants.



## SBA-4089

**SBA-4089Z** RoHS Compliant & Green Package

**DC-5 GHz, Cascadable InGaP/GaAs HBT MMIC Amplifier**



## Product Features

- Now available in Lead Free, RoHS Compliant, & Green Packaging
- $IP_3 = 33.5 \text{ dBm @ } 1950 \text{ MHz}$
- $P_{out} = 13.3 \text{ dBm @ } -45 \text{ dBc ACP IS-95 } 1950 \text{ MHz}$
- Robust 1000V ESD, Class 1C
- Operates From Single Supply
- Patented Thermal Design

## Applications

- PA Driver Amplifier
- Cellular, PCS, GSM, UMTS
- IF Amplifier
- Wireless Data, Satellite Terminals

| Symbol   | Parameter  | Units                | Frequency           | Min.         | Typ.         | Max.         |
|--|--|----------------------|---------------------|--------------|--------------|--------------|
| G  | Small Signal Gain                                  | dB                   | 850 MHz<br>1950 MHz | 13.5<br>13.1 | 15.0<br>14.6 | 16.5<br>16.1 |
| $P_{1dB}$  | Output Power at 1dB Compression                    | dBm                  | 850 MHz<br>1950 MHz | 17.5         | 19.2<br>19.0 |              |
| $OIP_3$  | Output Third Order Intercept Point                 | dBm                  | 850 MHz<br>1950 MHz | 31.5         | 36.5<br>33.5 |              |
| $P_{OUT}$  | Output Power @ -45dBc ACP IS-95 9 Forward Channels | dBm                  | 1950 MHz            |              | 13.3         |              |
| Bandwidth  | Determined by Return Loss (>10dB)                  | MHz                  |                     |              | 4400         |              |
| IRL  | Input Return Loss                                  | dB                   | 1950 MHz            | 14.0         | 21.0         |              |
| ORL  | Output Return Loss                                 | dB                   | 1950 MHz            | 11.0         | 15.0         |              |
| NF   | Noise Figure                                       | dB                   | 1950 MHz            |              | 4.8          | 5.8          |
| $V_D$  | Device Operating Voltage                           | V                    |                     | 4.8          | 5.0          | 5.4          |
| $I_D$  | Device Operating Current                           | mA                   |                     | 72           | 80           | 88           |
| $R_{TH, j-l}$  | Thermal Resistance (junction to lead)              | $^{\circ}\text{C/W}$ |                     |              | 70           |              |
| <b>Test Conditions:</b> $V_S = 8 \text{ V}$ $I_D = 80 \text{ mA Typ.}$ $OIP_3$ Tone Spacing = 1 MHz, $P_{out}$ per tone = 0 dBm<br>$R_{BIAS} = 39 \text{ Ohms}$ $T_L = 25^{\circ}\text{C}$ $Z_S = Z_L = 50 \text{ Ohms}$ |  |                      |                     |              |              |              |

Performance tests and ratings for Sirenza Microdevices' products were performed internally by Sirenza and measured using specific computer systems and/or components and reflect the approximate performance of the products as measured by those tests. Any difference in circuit implementation, test software or test equipment may affect actual performance. The information provided herein is believed to be reliable at press time and Sirenza Microdevices assumes no responsibility for the use of this information. All such use shall be entirely at the user's own risk. Prices and specifications for Sirenza Microdevices' products are subject to change without notice. Buyers should consult Sirenza Microdevices' standard terms and conditions of sale for Sirenza's limited warranty with regard to its products. No patent rights or licenses licenses to any of the circuits described herein are implied or granted to any third party. Sirenza Microdevices does not authorize or warrant any product for use in life-support devices and/or systems.

**Typical RF Performance at Key Operating Frequencies**

| Symbol           | Parameter                          | Unit | Frequency (MHz) |      |      |      |      |      |
|------------------|------------------------------------|------|-----------------|------|------|------|------|------|
|                  |                                    |      | 100             | 500  | 850  | 1950 | 2400 | 3500 |
| G                | Small Signal Gain                  | dB   | 15.3            | 15.3 | 15.0 | 14.6 | 14.3 | 13.2 |
| OIP <sub>3</sub> | Output Third Order Intercept Point | dBm  | 37.1            | 36.2 | 36.5 | 33.5 | 32.7 | 30.5 |
| P <sub>1dB</sub> | Output Power at 1dB Compression    | dBm  | 19.0            | 19.1 | 19.0 | 19.0 | 18.3 | 16.3 |
| IRL              | Input Return Loss                  | dB   | 47              | 33   | 29   | 21   | 17.5 | 13.3 |
| ORL              | Output Return Loss                 | dB   | 22              | 22   | 21   | 15   | 13.3 | 12   |
| S <sub>21</sub>  | Reverse Isolation                  | dB   | 18              | 18   | 18.7 | 19   | 19   | 19   |
| NF               | Noise Figure                       | dB   | 4.1             | 4.3  | 4.2  | 4.8  | ---  | ---  |

**Test Conditions:** V<sub>S</sub> = 8 V, I<sub>D</sub> = 80 mA Typ., OIP<sub>3</sub> Tone Spacing = 1 MHz, P<sub>out</sub> per tone = 0 dBm  
R<sub>BIAS</sub> = 39 Ohms, T<sub>L</sub> = 25°C, Z<sub>S</sub> = Z<sub>L</sub> = 50 Ohms

**Noise Figure vs Frequency**

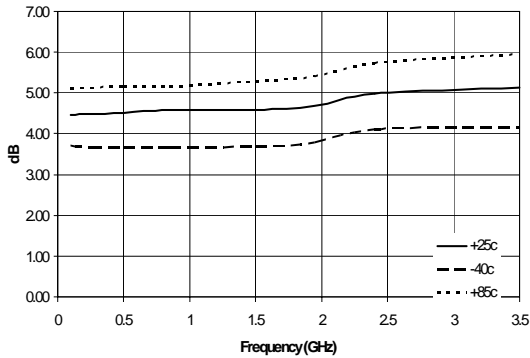

**Absolute Maximum Ratings**

| Parameter                               | Absolute Limit |
|---|----------------|
| Max. Device Current (I <sub>b</sub> )   | 130 mA         |
| Max. Device Voltage (V <sub>D</sub> )   | 6 V            |
| Max. RF Input Power                     | +17 dBm        |
| Max Operating Dissipated Power          | 0.65 W         |
| Max. Junction Temp. (T <sub>J</sub> )   | +150°C         |
| Operating Temp. Range (T <sub>L</sub> ) | -40°C to +85°C |
| Max. Storage Temp.                      | +150°C         |

Operation of this device beyond any one of these limits may cause permanent damage. For reliable continuous operation, the device voltage and current must not exceed the maximum operating values specified in the table on page one.

Bias Conditions should also satisfy the following expression:  
 $I_b V_D < (T_J - T_L) / R_{TH} \cdot J$       $T_L = T_{LEAD}$

**OIP3 vs Frequency**

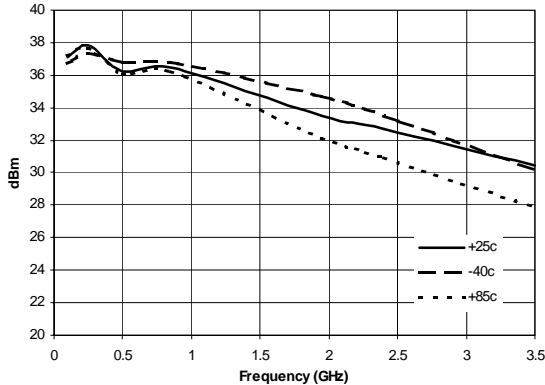

**P1dB vs Frequency**

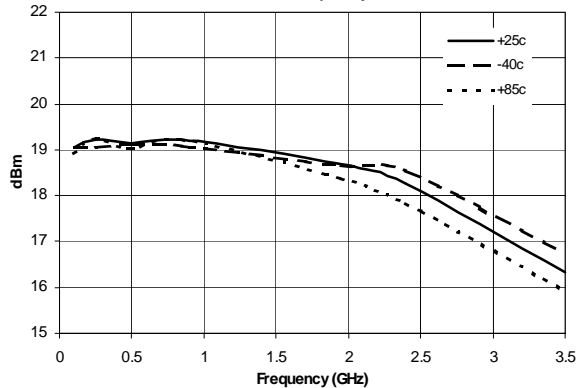

**$|S_{11}|$  vs. Frequency**

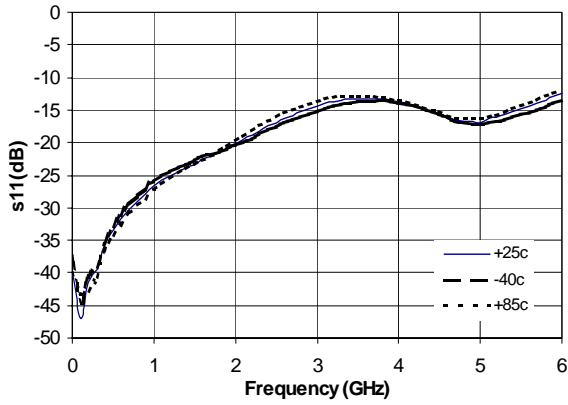

**$|S_{21}|$  vs. Frequency**

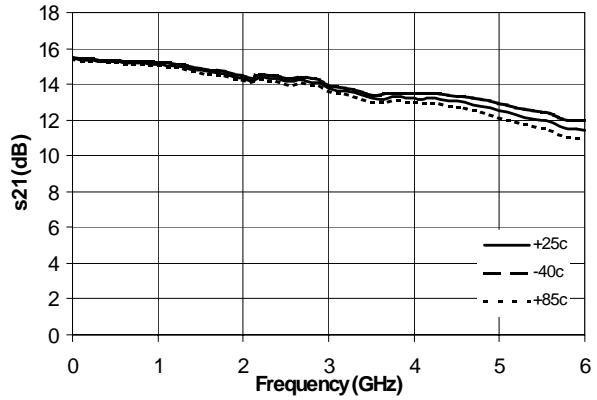

**$|S_{12}|$  vs. Frequency**

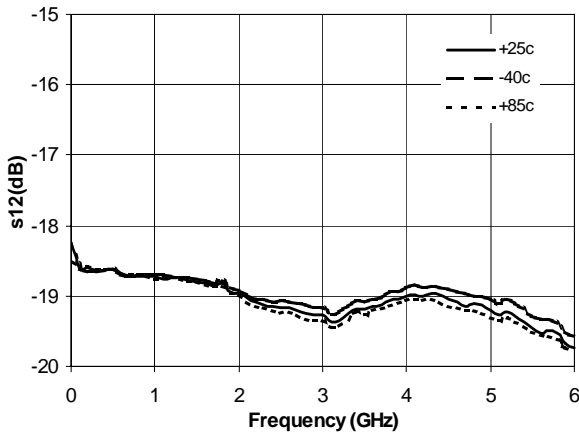

**$|S_{22}|$  vs. Frequency**

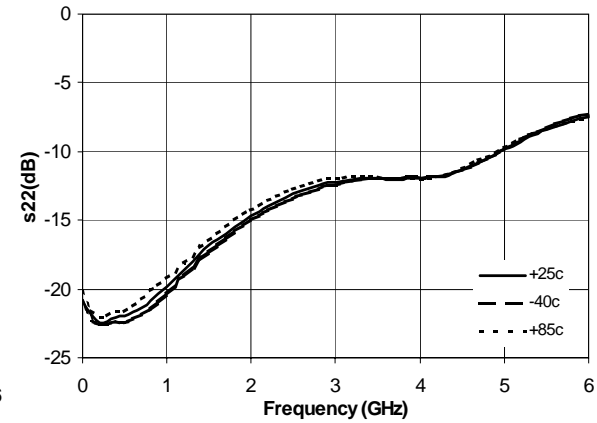

**IS-95 @ 850MHz  
Adj. Channel Pwr. Vs. Channel Output Pwr.**

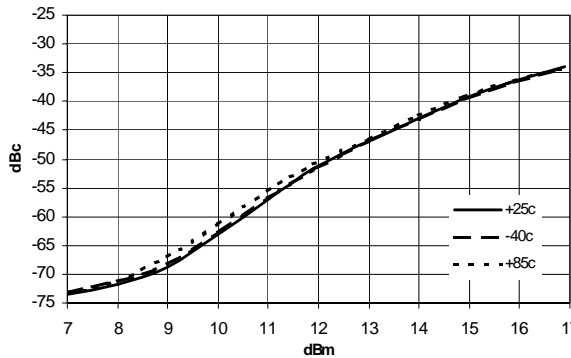

**IS-95 @ 1950MHz  
Adj. Channel Pwr. Vs. Channel Output Pwr.**

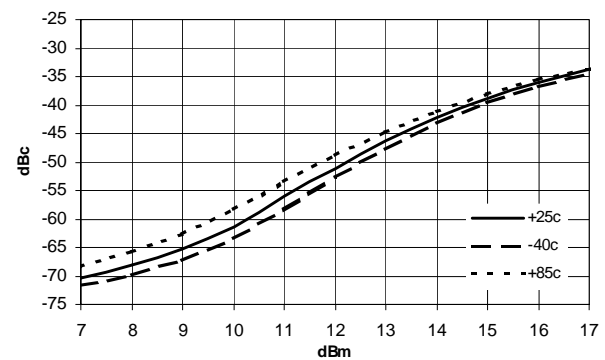

**Basic Application Circuit**

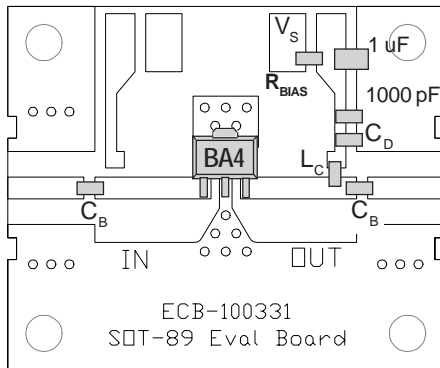
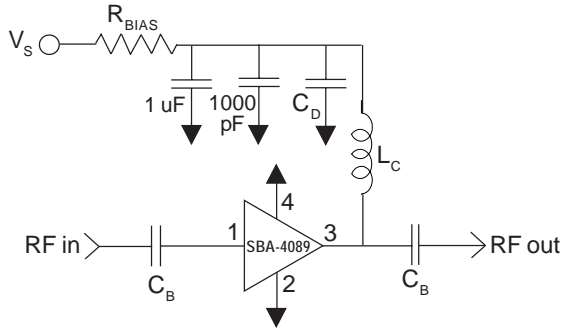

**Part Identification Marking**

The part will be marked with an "BA4" or "BA4Z" designator on the top surface of the package.

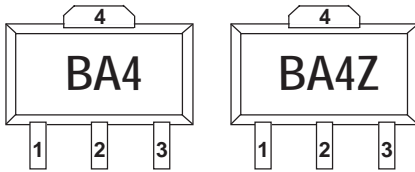

**Caution: ESD sensitive**  
Appropriate precautions in handling, packaging and testing devices must be observed.

**Application Circuit Element Values**

| Reference Designator | Frequency (MHz) |        |       |       |       |
|----------------------|-----------------|--------|-------|-------|-------|
|                      | 500             | 850    | 1950  | 2400  | 3500  |
| C <sub>B</sub>       | 220 pF          | 100 pF | 68 pF | 56 pF | 39 pF |
| C <sub>D</sub>       | 100 pF          | 68 pF  | 22 pF | 22 pF | 15 pF |
| L <sub>C</sub>       | 68 nH           | 33 nH  | 22 nH | 18 nH | 15 nH |

**Recommended Bias Resistor Values for I<sub>D</sub>=80mA**

$$R_{BIAS} = (V_S - V_D) / I_D$$

| Supply Voltage(V <sub>S</sub> ) | 7.5 V | 8 V  | 10 V | 12 V |
|---------------------------------|-------|------|------|------|
| R <sub>BIAS</sub>               | 33 Ω  | 39 Ω | 68 Ω | 91 Ω |

Note: R<sub>BIAS</sub> provides DC bias stability over temperature.

**Mounting Instructions**

1. Solder the copper pad on the backside of the device package to the ground plane.
2. Use a large ground pad area with many plated through-holes as shown.
3. We recommend 1 or 2 ounce copper. Measurement for this data sheet were made on a 31 mil thick FR-4 board with 1 ounce copper on both sides.

| Pin # | Function    | Description   |
|-------|-------------|---|
| 1     | RF IN       | RF input pin. This pin requires the use of an external DC blocking capacitor chosen for the frequency of operation.             |
| 2, 4  | GND         | Connection to ground. Use via holes for best performance to reduce lead inductance as close to ground leads as possible.        |
| 3     | RF OUT/BIAS | RF output and bias pin. DC voltage is present on this pin, therefore a DC blocking capacitor is necessary for proper operation. |

**Part Number Ordering Information**

| Part Number | Reel Size | Devices/Reel |
|-------------|-----------|--------------|
| SBA-4089    | 7"        | 1000         |
| SBA-4089Z   | 7"        | 1000         |

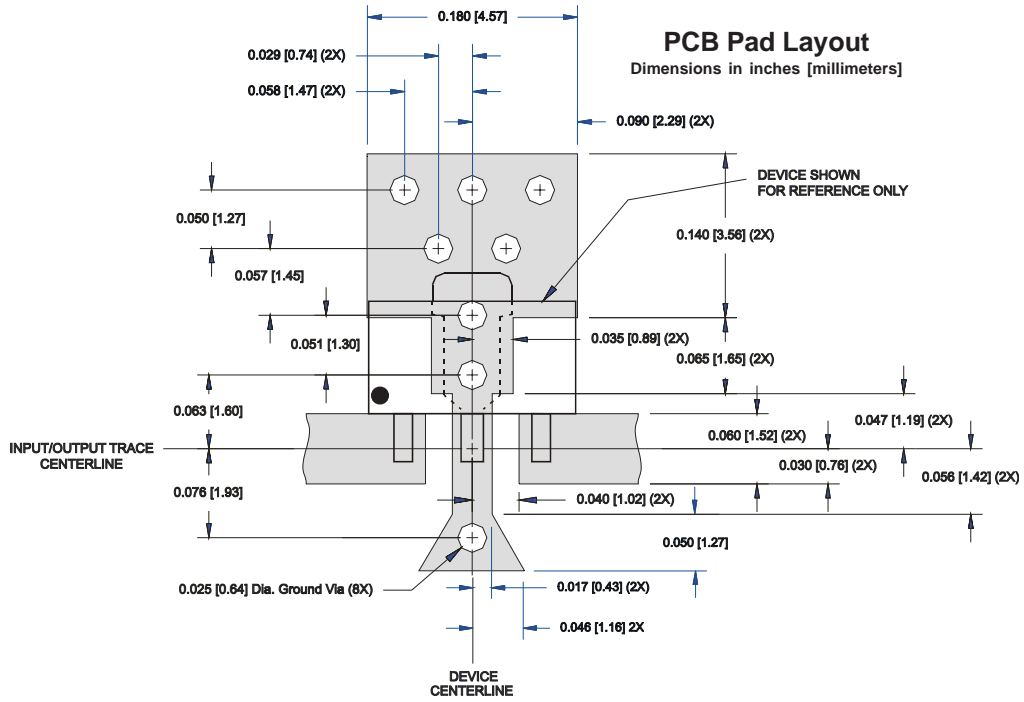

### Nominal Package Dimensions

Dimensions in inches [millimeters]

Refer to package drawing posted at [www.sirenza.com](http://www.sirenza.com) for tolerances.

