



Schottky Barrier Rectifier

SBLB2030CT-SBLB20100CT

FEATURES

- Metal-Semiconductor Junction With Guard Ring
- Epitaxial Construction.
- Low Forward Voltage Drop,Low Switching Losses.
- High Surge Capacity.
- For Use In Low Voltage,High Frequency Inverters Free Wheeling,and Polarity Protection Applications.
- The Plastic Material Carries U/L Recognition 94V-0.



Lead-free

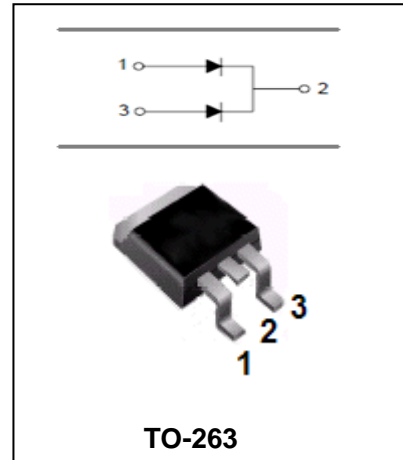

MAXIMUM RATING operating temperature range applies unless otherwise specified

Symbol	Parameter	SBLB 2030 CT	SBLB 2035 CT	SBLB 2040 CT	SBLB 2045 CT	SBLB 2050 CT	SBLB 2060 CT	SBLB 2080 CT	SBLB 20100 CT	Unit
V_{RRM}	Recurrent Peak Reverse Voltage	30	35	40	45	50	60	80	100	V
V_{RMS}	RMS Voltage	21	25	28	32	35	42	56	70	V
V_{DC}	DC Blocking Voltage	30	35	40	45	50	60	80	100	V
$I_{F(AV)}$	Average Forward Rectified Current @ $T_A=100^{\circ}C$	20								A
I_{FSM}	Peak Forward Surge Current 8.3ms Single Half Sine-wave Superimosed on Rated Load	250								A
$R_{\theta JC}$	Thermal Resistance(Note1)	1.5								$^{\circ}C/W$
T_j	Operating Junction Temperature Range	-55 to +125								$^{\circ}C$
T_{stg}	Storage Temperature Range	-55 to +150								$^{\circ}C$

Note:1.Thermal resistance junction to case.



Schottky Barrier Rectifier

SBLB2030CT-SBLB20100CT

ELECTRICAL CHARACTERISTICS @ Ta=25°C unless otherwise specified.

Parameter	Symbol	Test conditions	SBLB2030CT-SBLB2045CT	SBLB2050CT-SBLB2060CT	SBLB2080CT-SBLB20100CT	UNIT
			MAX			
Forward Voltage	V _F	I _F =10A	0.60	0.75	0.85	V
Reverse Current	I _R	V _R =V _{RRM} , T _A =25°C V _R =V _{RRM} , T _A =100°C	1.0 50			mA

TYPICAL CHARACTERISTICS @ Ta=25°C unless otherwise specified

FIG.1 – PEAK FORWARD SURGE CURRENT

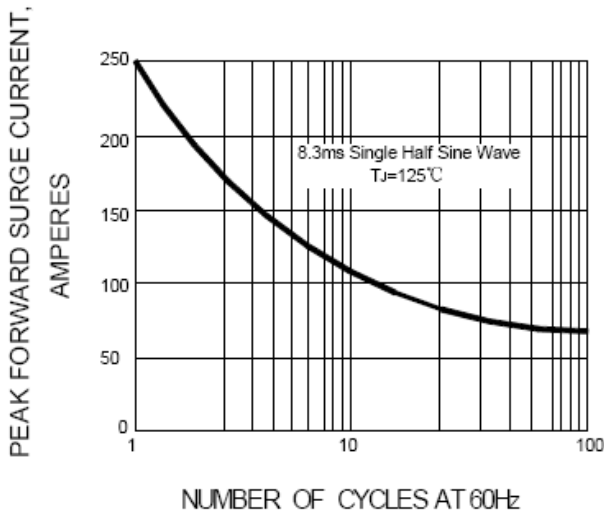

FIG.2 – FORWARD DERATING CURVE

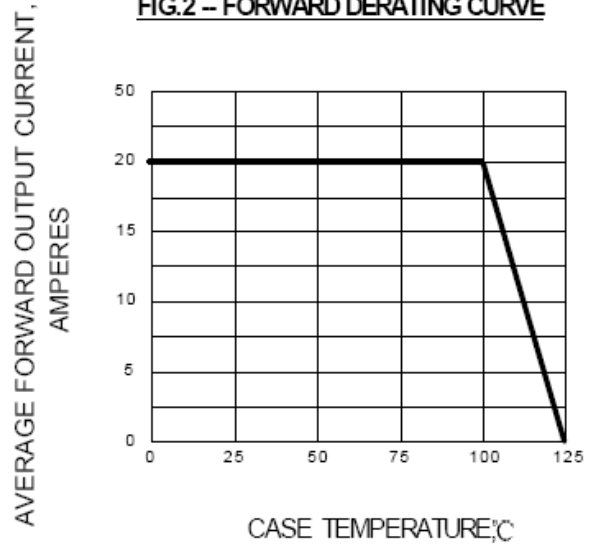

FIG.3 – TYPICAL FORWARD CHARACTERISTIC

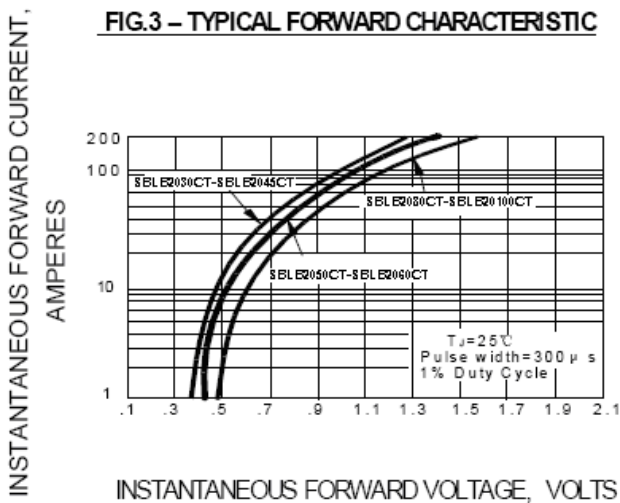
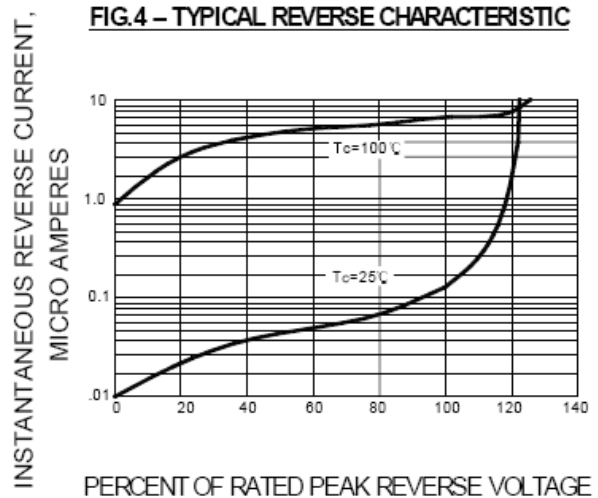

FIG.4 – TYPICAL REVERSE CHARACTERISTIC





Schottky Barrier Rectifier

SBLB2030CT-SBLB20100CT

PACKAGE OUTLINE

Plastic surface mounted package

TO-263

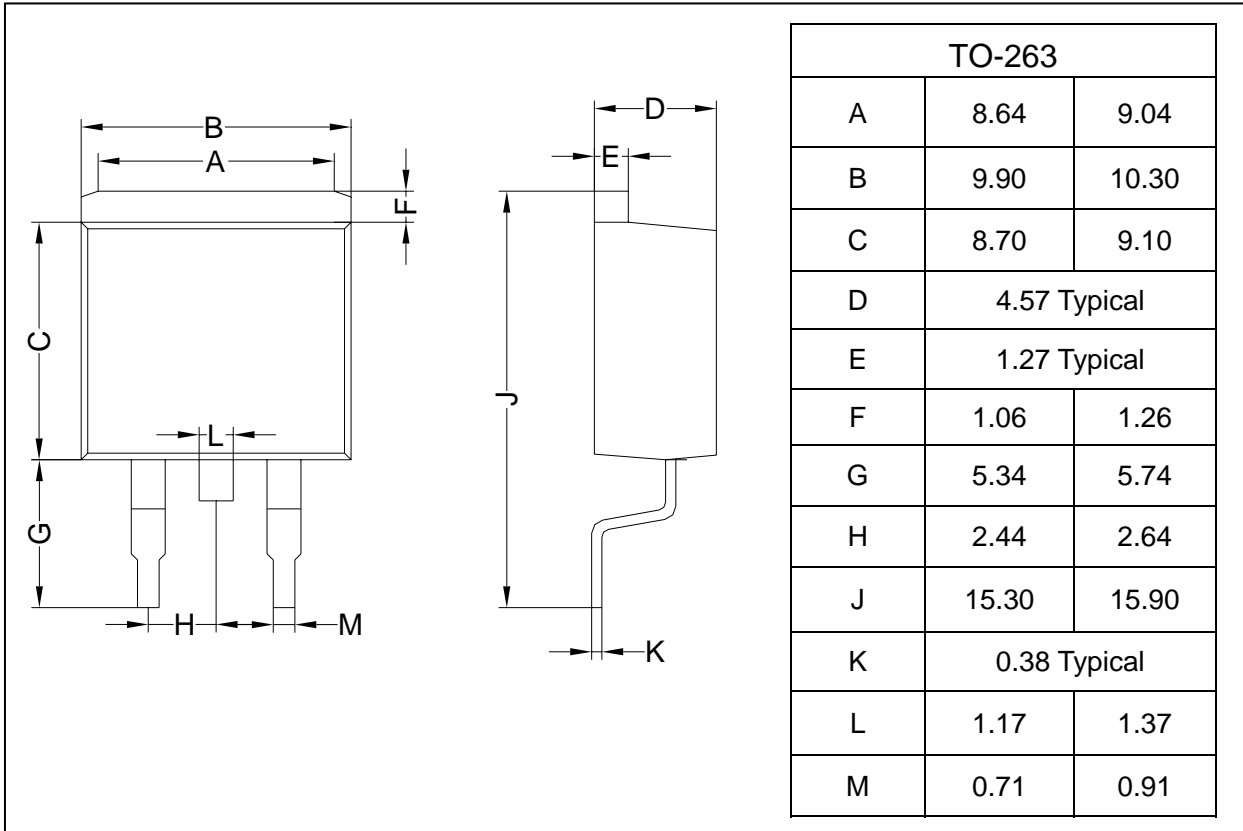

SOLDERING FOOTPRINT

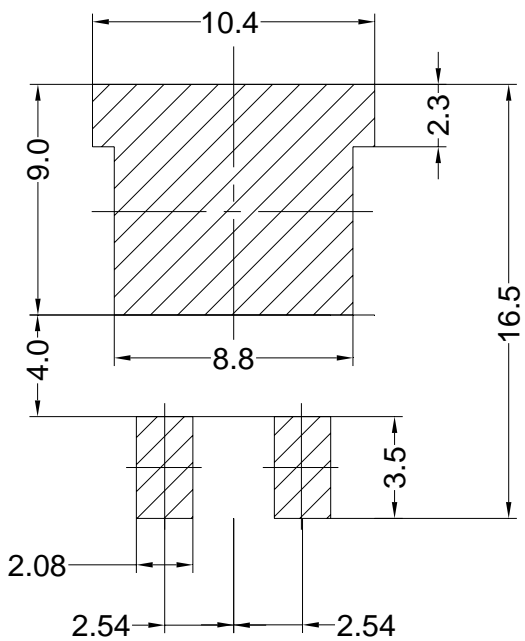

Unit:mm