



SBR345L

主要参数 MAIN CHARACTERISTICS

$I_{F(AV)}$	3A
V_{RRM}	45 V
T_j	150°C
$V_{F(max)}$	0.38V (@ $T_j=100^\circ\text{C}$)

用途

- 低压高频整流
- 低压续流电路和保护电路

APPLICATIONS

- Low voltage, high frequency rectifier
- Free wheeling diodes, polarity protection applications

封装 Package

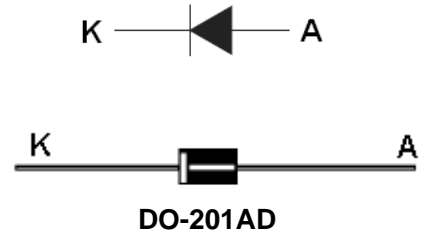

产品特性

- 低功耗，高效率
- 良好的高温特性
- 有过压保护环，高可靠性
- 环保（RoHS）产品

FEATURES

- Low power loss, high efficiency
- High Operating Junction Temperature
- Guard ring for overvoltage protection, High reliability
- RoHS product

订货信息 ORDER MESSAGE

订货型号 Order codes	印 记 Marking	封 装 Package	无卤素 Halogen Free	包 装 Packaging	器件重量 Device Weight
SBR345LDR	SBR345L	DO-201AD	是 YES	编带 Tape	1.1g(approx.)
SBR345LD	SBR345L	DO-201AD	否 NO	编带 Tape	1.1g(approx.)
SBR345LXFR	SBR345L	SMAF	是 YES	编带 Tape	0.030g(approx.)
SBR345LXF	SBR345L	SMAF	否 NO	编带 Tape	0.030g(approx.)
SBR345LSXR	SBR345L	SMA	是 YES	编带 Tape	0.071g(approx.)
SBR345LSX	SBR345L	SMA	否 NO	编带 Tape	0.071g(approx.)
SBR345LSKR	SBR345L	SMB	是 YES	编带 Tape	0.096g(approx.)
SBR345LSK	SBR345L	SMB	否 NO	编带 Tape	0.096g(approx.)
SBR345LSKFR	SBR345L	SMBF	是 YES	编带 Tape	0.075g(approx.)
SBR345LSKF	SBR345L	SMBF	否 NO	编带 Tape	0.075g(approx.)



**绝对最大额定值 ABSOLUTE RATINGS (Tc=25℃)**

项 目 Parameter	符 号 Symbol	数 值 Value	单 位 Unit
最大反向重复峰值电压 Repetitive peak reverse voltage	V_{RRM}	45	V
最大直流阻断电压 Maximum DC blocking voltage	V_{DC}	45	V
正向平均整流电流 Average forward current	$I_{F(AV)}$	3	A
正向峰值浪涌电流 Surge non repetitive forward current (额定负载 8.3ms 半正弦波—按 JEDEC 方法) 8.3 ms single half-sine-wave (JEDEC Method)	I_{FSM}	80	A
最高结温 Maximum junction temperature	T_j	150	℃
储存温度 Storage temperature range	T_{STG}	-55~+150	℃

电特性 ELECTRICAL CHARACTERISTICS

项 目 Parameter	测试条件 Tests conditions	最小值 Value(min)	典型值 Value(typ)	最大值 Value(max)	单 位 Unit
I_R	$T_j = 25^\circ\text{C}$		140	220	μA
	$T_j = 100^\circ\text{C}$		50	mA	
V_F	$T_j = 25^\circ\text{C}$		0.39	0.45	V
	$T_j = 100^\circ\text{C}$		0.36	0.38	V

热特性 THERMAL CHARACTERISTICS

项 目 Parameter	符 号 Symbol	最小值 Value(min)	最大值 Value(max)	单 位 Unit
结到壳的热阻 Thermal resistance from junction to case	$R_{th(j-c)}$		35 50 45	℃/W
结到环境的热阻 Thermal resistance from junction to ambient	$R_{th(j-a)}$		70 140 120	





特征曲线 ELECTRICAL CHARACTERISTICS (curves)

IF vs VF

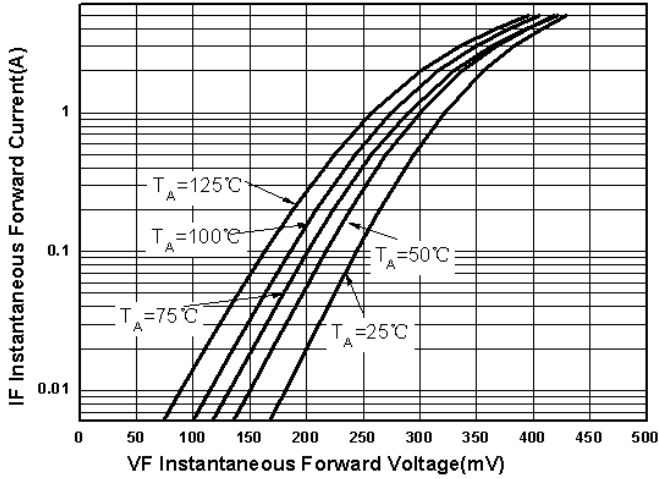

IR vs VR

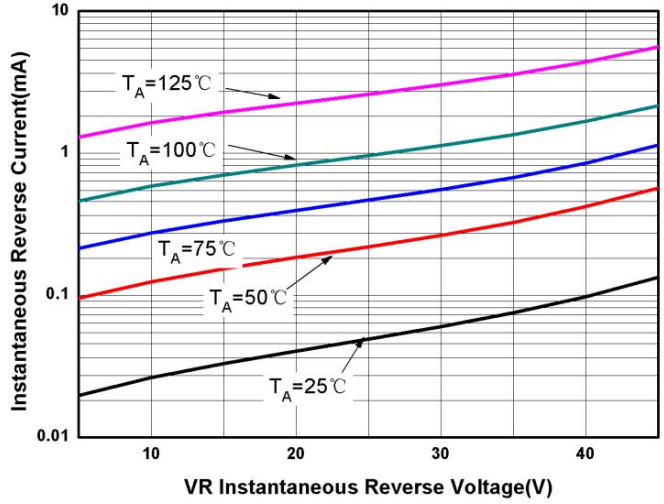

IF(AV) vs TC(°C)

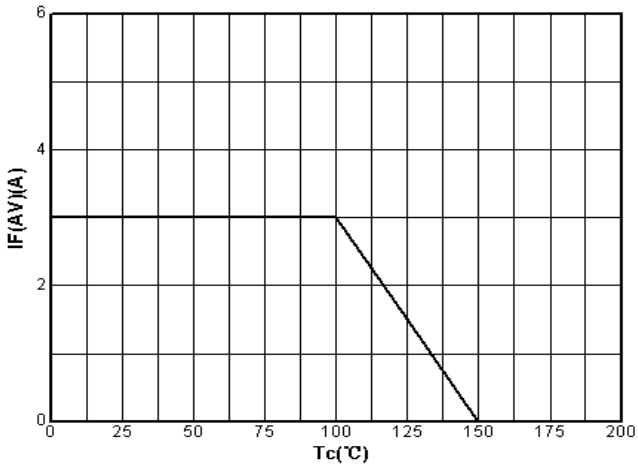

CJ vs VR

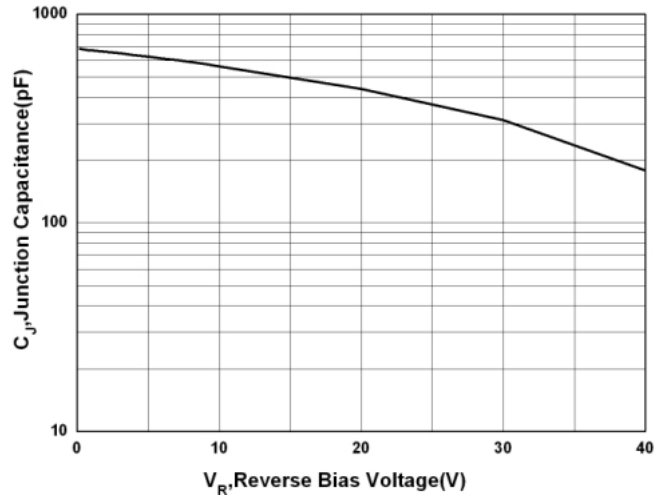

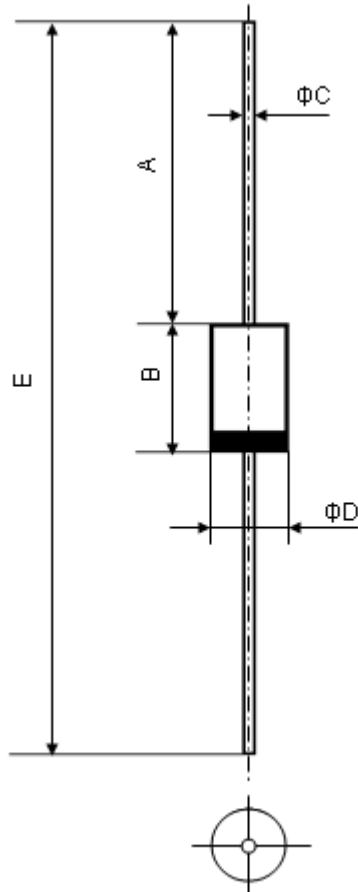

符号 Symbol	Min	Max
A	25.4	--
B	8.5	9.5
C	1.2	1.3
D	5.0	5.6
E	59.5	64



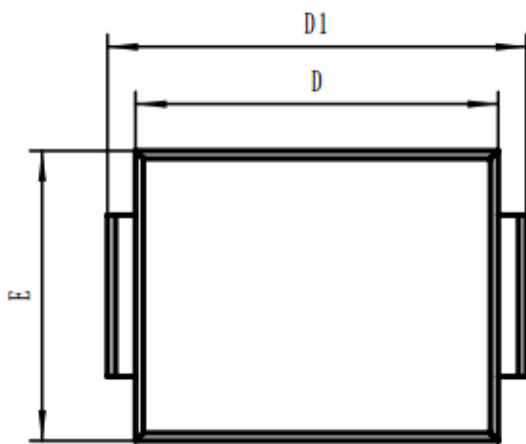
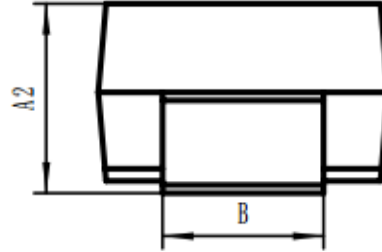
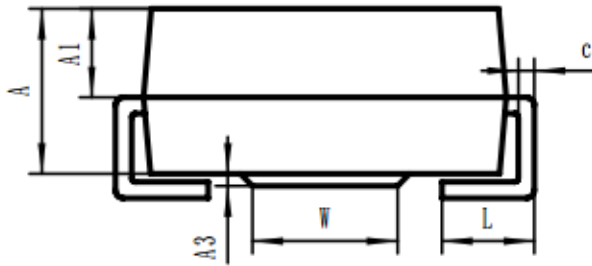

SYMBOL	MIN	MAX
A	1.85	2.25
A1	0.90	1.30
A2	2.10	2.60
A3	0.10	0.20
B	1.80	2.20
c	0.10	0.30
D	4.30	4.70
D1	4.95	5.45
E	3.40	3.80
L	0.80	1.50
W	1.60	2.00



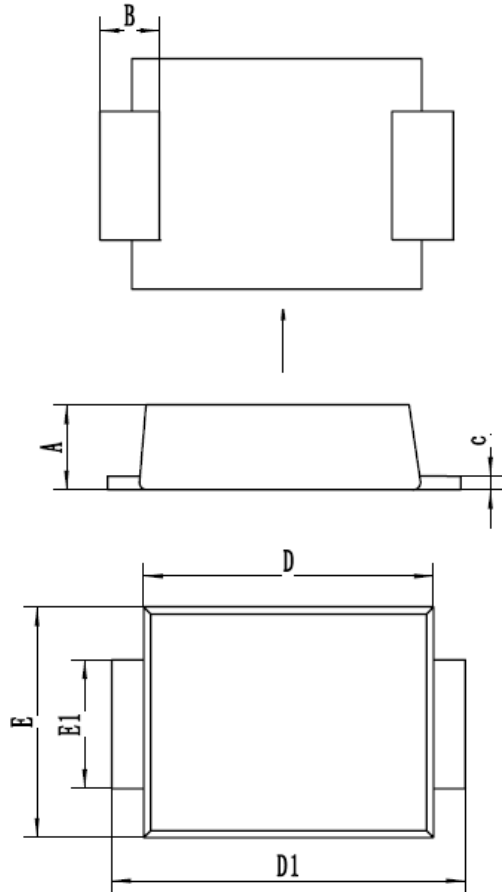

符号 symbol	Min	Max
A	1.10	1.30
B	0.80	1.10
C	0.15	0.25
D	4.3	4.7
D1	5.3	5.7
E	3.4	3.8
E1	1.90	2.10





SBR345L

外形尺寸 PACKAGE MECHANICAL DATA

SMA

单位 Unit : mm

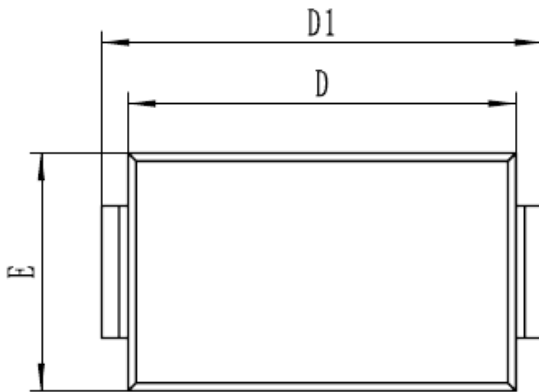
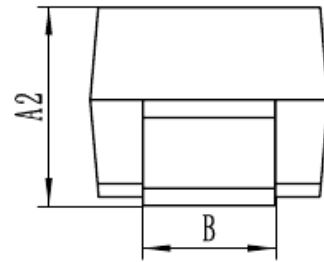
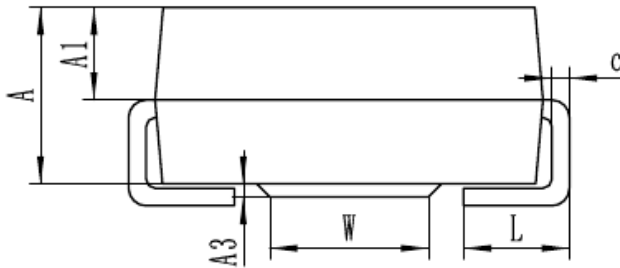

SYMBOL	MM	
	MIN	MAX
A	1.70	2.10
A1	0.85	1.25
A2	1.90	2.60
A3	0.10	0.20
B	1.30	1.70
c	0.15	0.25
D	4.30	4.70
D1	4.70	5.30
E	2.50	2.90
L	0.85	1.55
W	1.60	2.00



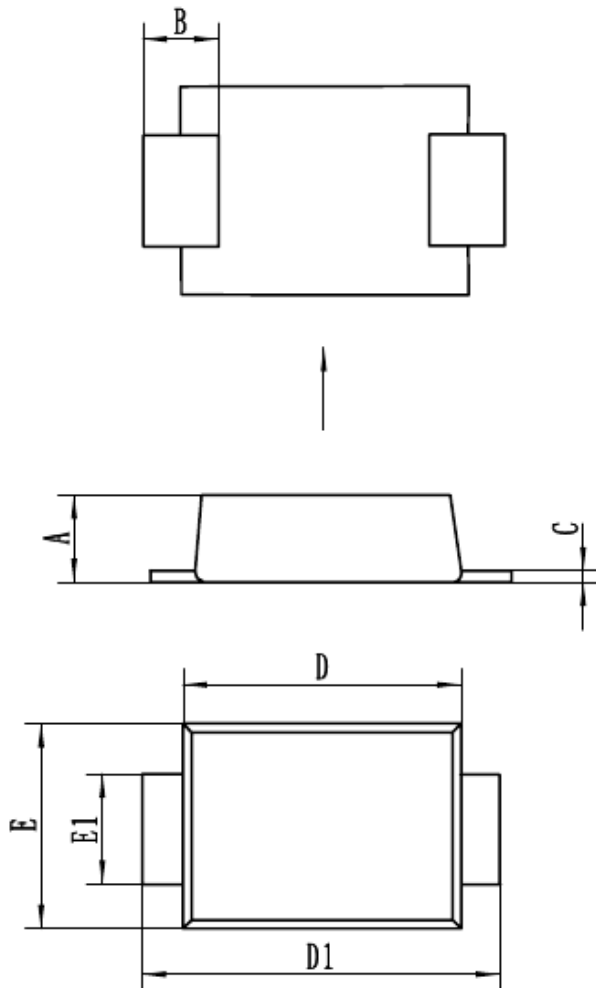

符号 symbol	Min	Max
A	0.90	1.10
B	0.90	1.20
C	0.10	0.15
D	3.3	3.7
D1	4.4	4.8
E	2.4	2.8
E1	1.30	1.50





注意事项

- 1.吉林华微电子股份有限公司的产品销售分为直销和销售代理,无论哪种方式,订货时请与公司核实。
- 2.购买时请认清公司商标,如有疑问请与公司本部联系。
- 3.在电路设计时请不要超过器件的绝对最大额定值,否则会影响整机的可靠性。
- 4.本说明书如有版本变更不另外告知

NOTE

1. Jilin Sino-microelectronics co., Ltd sales its product either through direct sales or sales agent , thus, for customers, when ordering , please check with our company.
2. We strongly recommend customers check carefully on the trademark when buying our product, if there is any question, please don't be hesitate to contact us.
3. Please do not exceed the absolute maximum ratings of the device when circuit designing.
4. Jilin Sino-microelectronics co., Ltd reserves the right to make changes in this specification sheet and is subject to change without prior notice.

联系方式

吉林华微电子股份有限公司

公司地址: 吉林省吉林市深圳街 99 号

邮编: 132013

总机: 86-432-64678411

传真: 86-432-64665812

网址: www.hwdz.com.cn

市场营销部

地址: 吉林省吉林市深圳街 99 号

邮编: 132013

电话: 86-432-64675588

64675688

64678411-3098/3099

传真: 86-432-64671533

CONTACT

JILIN SINO-MICROELECTRONICS CO., LTD.

ADD: No.99 Shenzhen Street, Jilin City, Jilin Province, China.

Post Code: 132013

Tel: 86-432-64678411

Fax: 86-432-64665812

Web Site: www.hwdz.com.cn

MARKET DEPARTMENT

ADD:No.99 Shenzhen Street, Jilin City, Jilin Province, China.

Post Code: 132013

Tel: 86-432-64675588

64675688

64678411-3098/3099

Fax: 86-432-64671533

附录 (Appendix): 修订记录 (Revision History)

日期 Date	旧版本 Last Rev.	新版本 New Rev.	修订内容 Description of Changes
20150929	201502C	201510D	增加 SMA\SMAF 外型
20151028	201510D	201510E	Corrected the mistakes.
20160322	201510E	201603F	修改 SMBF 规格书外形图

