

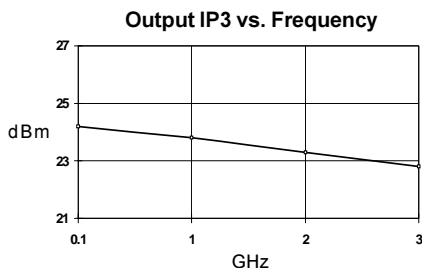

## Product Description

Sirenza Microdevices' SCA-17 is a high performance Gallium Arsenide Heterojunction Bipolar Transistor MMIC Amplifier. A Darlington configuration is utilized for broadband performance up to 3 GHz. The heterojunction increases breakdown voltage and minimizes leakage current between junctions. Cancellation of emitter junction non-linearities results in higher suppression of intermodulation products. Typical IP3 at 40mA is +23dBm.

These unconditionally stable amplifiers provides 21dB of gain and +12dBm of 1dB compressed power and requires only a single positive voltage supply. Only 2 DC-blocking capacitors, a bias resistor and an optional inductor are needed for operation.



## SCA-17

### DC-3 GHz, Cascadable GaAs HBT MMIC Amplifier

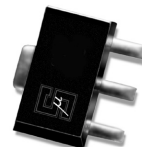

### Product Features

- High Output IP3 : +23dBm
- High Gain : Up to 21dB
- Cascadable 50 Ohm : 1.5:1 VSWR
- Patented GaAs HBT Technology
- Operates From Single Supply
- Low Thermal Resistance Package

### Applications

- PA Driver Amplifier
- Cellular, PCS, GSM, UMTS
- IF Amplifier
- Wireless Data, Satellite

Symbol	Parameter	Units	Frequency	Min.	Typ.	Max.
$G_p$	Small Signal Power Gain	dB	850 MHz	19.4	21.5	23.7
		dB	1950 MHz		20.5	
		dB	2400 MHz		20.0	
$G_F$	Gain Flatness	dB	0.1-2 GHz		+/- 1.2	
$P_{1dB}$	Output Power at 1dB Compression	dBm	1950 MHz		12.0	
$OIP_3$	Output Third Order Intercept Point	dBm	1950 MHz		23.0	
NF	Noise Figure	dB	1950 MHz		3.8	
VSWR	Input / Output	-	0.1-3 GHz		1.5:1	
ISOL	Reverse Isolation	dB	0.1-3 GHz		22	
$V_D$	Device Operating Voltage	V		3.3	3.7	4.1
$I_D$	Device Operating Current	mA		35	40	45
dG/dT	Device Gain Temperature Coefficient	dB/°C			-0.003	
$R_{TH, j-l}$	Thermal Resistance (junction to lead)	°C/W			510	

**Test Conditions:**

$$V_S = 8 \text{ V}$$

$$R_{BIAS} = 110 \text{ Ohms}$$

$$I_D = 40 \text{ mA Typ.}$$

$$T_L = 25^\circ\text{C}$$

$$OIP_3 \text{ Tone Spacing} = 1 \text{ MHz, } P_{out} \text{ per tone} = 0 \text{ dBm}$$

$$Z_S = Z_L = 50 \text{ Ohms}$$

The information provided herein is believed to be reliable at press time. Sirenza Microdevices assumes no responsibility for inaccuracies or omissions. Sirenza Microdevices assumes no responsibility for the use of this information, and all such information shall be entirely at the user's own risk. Prices and specifications are subject to change without notice. No patent rights or licenses to any of the circuits described herein are implied or granted to any third party. Sirenza Microdevices does not authorize or warrant any Sirenza Microdevices product for use in life-support devices and/or systems. Copyright 2001 Sirenza Microdevices, Inc. All worldwide rights reserved.

**Typical Performance at 25 °C (Vds = 3.7V, Ids = 40mA)**

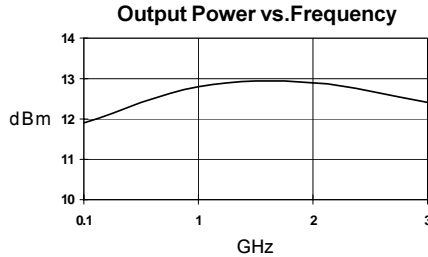
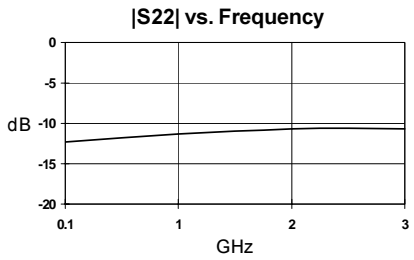
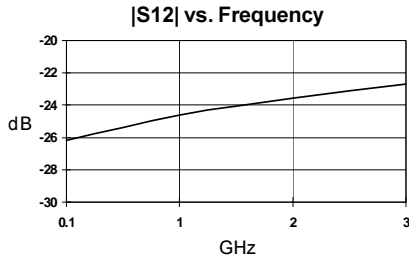
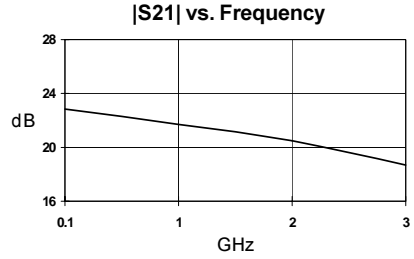
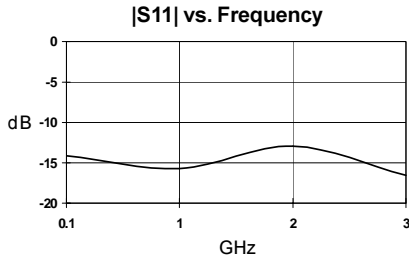

**Typical S-Parameters Vds = 3.7V, Id = 40mA**

Freq GHz	S11	S11 Ang	S21	S21 Ang	S12	S12 Ang	S22	S22 Ang
.100	0.338	117	13.126	139	0.064	-19	0.326	118
.500	0.322	112	13.096	130	0.056	-25	0.317	113
.900	0.310	61	12.333	93	0.057	-46	0.320	64
1.00	0.305	47	12.165	83	0.059	-50	0.320	51
1.50	0.271	-13	11.356	38	0.062	-79	0.316	-9
2.00	0.225	-71	10.626	-7	0.066	-107	0.307	-67
2.50	0.179	-129	9.175	-52	0.070	-138	0.298	-126
3.00	0.148	172	8.363	-90	0.073	-173	0.291	177

(S-Parameters include the effects of two 1.0 mil diameter bond wires, each 20 mils long, connected to the gate and drain pads on the die)

## Absolute Maximum Ratings

Parameter	Absolute Limit
Max. Device Current ( $I_D$ )	75 mA
Max. Device Voltage ( $V_D$ )	6 V
Max. RF Input Power	+20 dBm
Max. Junction Temp. ( $T_J$ )	+150°C
Operating Temp. Range ( $T_L$ )	-40°C to +85°C
Max. Storage Temp.	+150°C

Operation of this device beyond any one of these limits may cause permanent damage. For reliable continuous operation, the device voltage and current must not exceed the maximum operating values specified in the table on page one.

Bias Conditions should also satisfy the following expression:

$$I_D V_D < (T_J - T_L) / R_{TH} \text{ J-1}$$

## Typical Biasing Configuration

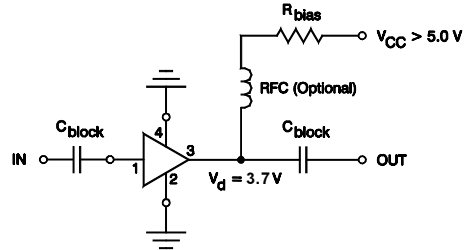

Recommended Bias Resistor Values	
Supply Voltage ( $V_S$ )	5V 7.5V 8V 9V 10V 12V
Rbias (Ohms)	33 91 110 130 160 200

## Mounting Instructions

The data shown was taken on a 31 mil thick FR-4 board with 1 ounce of copper on both sides. The board was mounted to a baseplate with 3 screws as shown. The screws bring the top side copper temperature to the same value as the baseplate.

1. Use 1 or 2 ounce copper, if possible.
2. Solder the copper pad on the backside of the device package to the ground plane.
3. Use a large ground pad area with many plated through-holes as shown.
4. If possible, use at least one screw no more than 0.2 inch from the device package to provide a low thermal resistance path to the baseplate of the package.
5. Thermal resistance from ground lead to screws is 2 deg. C/W.

Pin Designation	
1	RF in
2	GND
3	RF out and Bias
4	GND

## Outline Drawing

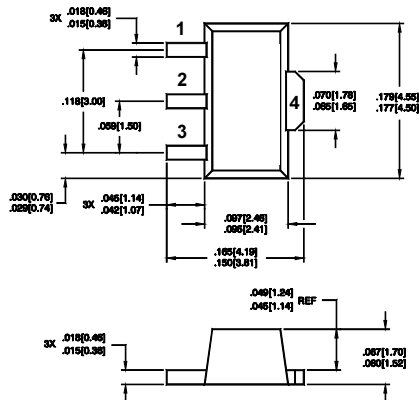

DIMENSIONS ARE IN INCHES [MM]

Pin assignments shown for reference only, not marked on part

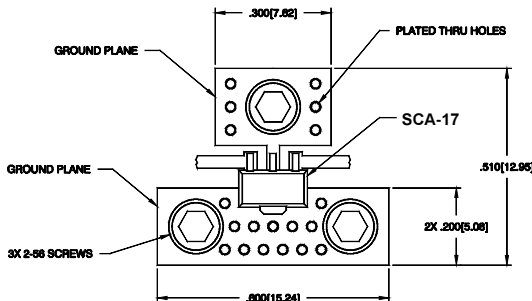

DIMENSIONS ARE IN INCHES [MM]