

Features

- Ultra low leakage: nA level
- Operating voltage: 7V
- Low clamping voltage
- 2-pin leadless package
- Complies with following standards:
 - IEC 61000-4-2 (ESD) immunity test
 - Air discharge: $\pm 30\text{kV}$
 - Contact discharge: $\pm 30\text{kV}$
 - IEC61000-4-4 (EFT) 80A (5/50ns)
 - IEC61000-4-5 (Lightning)75A (8/20 μs)
- RoHS Compliant

Dimensions DFN1610-2



Pin Configuration

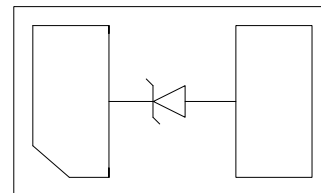

Applications

- Mobile Phones and Accessories
- Battery Protection
- USB VBus
- Power Line Protection
- Hand Held Portable Applications

Mechanical Characteristics

- Package: DFN1610-2
- Lead Finish: NiPdAu
- Case Material: “Green” Molding Compound.
- UL Flammability Classification Rating 94V-0
- Moisture Sensitivity: Level 3 per J-STD-020
- Quantity Per Reel:3,000pcs
- Reel Size:7 inch

Absolute Maximum Ratings (Tamb=25°C unless otherwise specified)

Parameter	Symbol	Value	Unit
Peak Pulse Power (8/20 μs)	Ppp	1500	W
ESD per IEC 61000-4-2 (Air)	V _{ESD}	± 30	Kv
ESD per IEC 61000-4-2 (Contact)		± 30	
Operating Temperature Range	T _J	-55 to +125	°C
Storage Temperature Range	T _{STJ}	-55 to +150	°C

Electrical Characteristics (TA=25°C unless otherwise specified)

Part Number	Device Marking	V _{RWM} (V)	V _{BR} (V)	I _T (mA)	V _C @10A	V _c		I _R μA (Max)	C (Pf) (Typ.)
						(Max)	(@A)		
SD0771P6W	76	7	7.5	1	12	20	75	0.5	550

Characteristic Curves

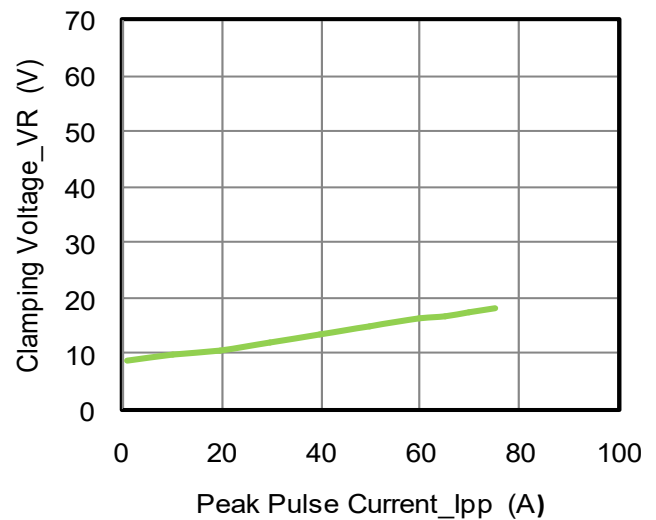
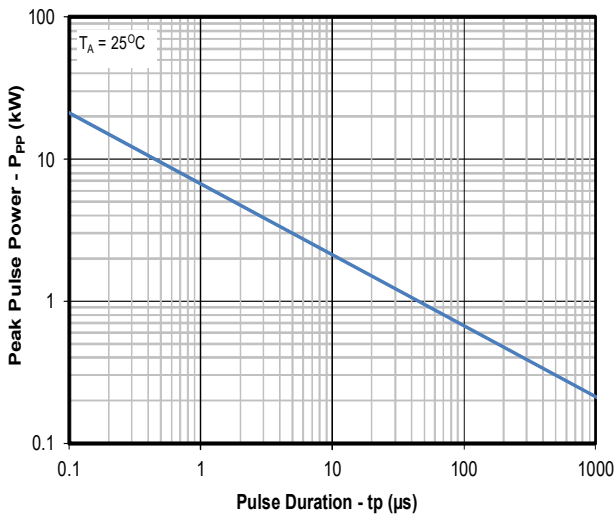

Junction Capacitance vs. Reverse Voltage

Clamping Voltage vs. Peak Pulse Current

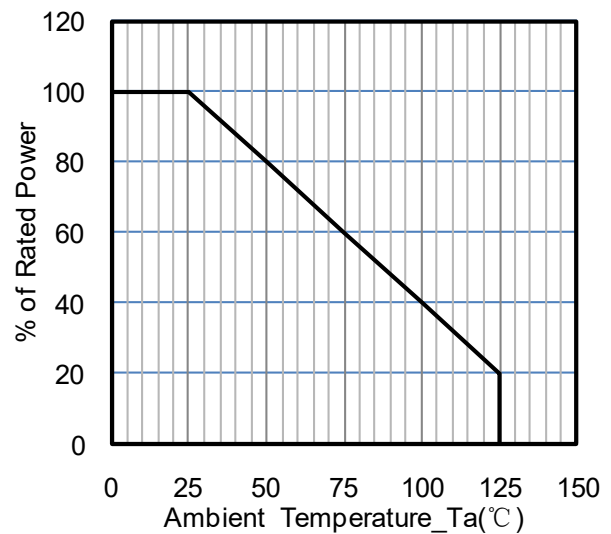
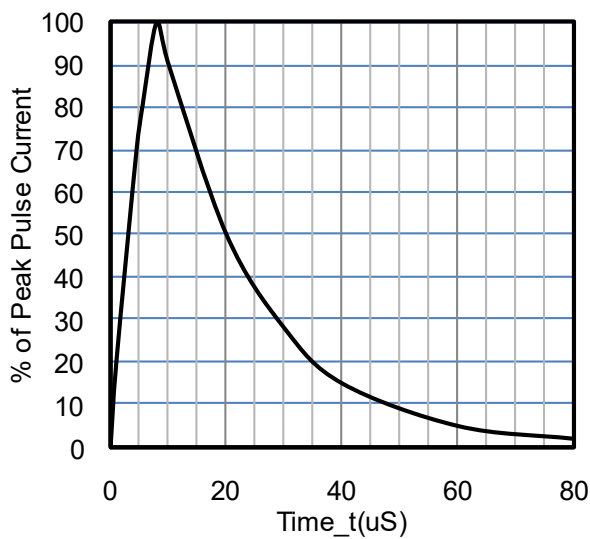

8 X 20uS Pulse Waveform

Power Derating Curve

DFN1610-2 Package Outline Drawing

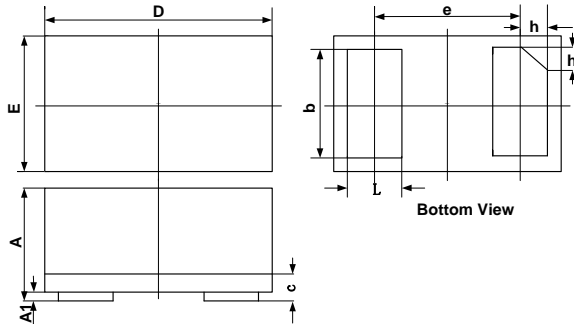

SYM	DIMENSIONS					
	MILLIMETERS			INCHES		
	MIN	NOM	MAX	MIN	NOM	MAX
A	0.45	0.50	0.55	0.018	0.020	0.022
A1	0.00	0.02	0.05	0.000	0.001	0.002
b	0.75	0.80	0.85	0.030	0.032	0.034
c	0.10	0.15	0.20	0.004	0.006	0.008
D	1.55	1.60	1.65	0.062	0.064	0.066
e	1.10 BSC			0.044 BSC		
E	0.95	1.00	1.05	0.038	0.040	0.042
L	0.35	0.40	0.45	0.014	0.016	0.018
h	0.15	0.20	0.25	0.006	0.008	0.010

Suggested Land Pattern

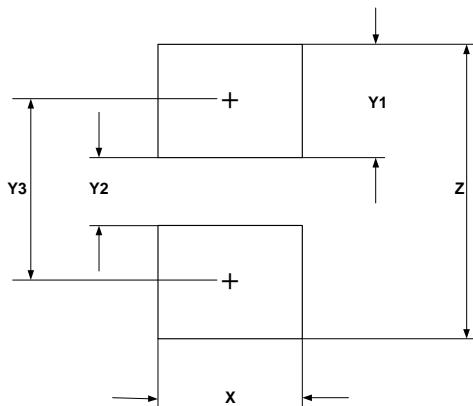

SYM	DIMENSIONS	
	MILLIMETERS	INCHES
X	1.00	0.040
Y1	0.62	0.025
Y2	0.60	0.024
Y3	1.22	0.049
Z	1.85	0.074