

### Features

- Schottky Barrier Chip
- Guard Ring Die Construction for Transient Protection
- High Current Capability
- Low Power Loss, High Efficiency
- High Surge Current Capability
- For Use in Low Voltage, High Frequency Inverters, Free Wheeling, and Polarity Protection Applications

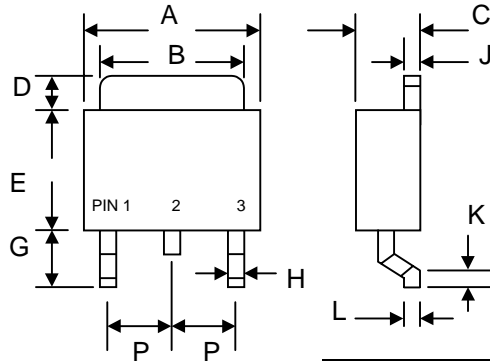

### Mechanical Data

- Case: Molded Plastic
- Terminals: Plated Leads Solderable per MIL-STD-750, Method 2026
- Polarity: Cathode Band
- Weight: 0.4 grams (approx.)
- Mounting Position: Any
- Marking: Type Number
- Standard Packaging: 16mm Tape (EIA-481)

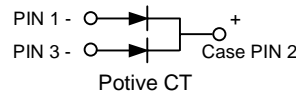

D PAK/TO-252AA		
Dim	Min	Max
A	6.4	6.8
B	5.0	5.4
C	2.35	2.75
D	—	1.60
E	5.3	5.7
G	2.3	2.7
H	0.4	0.8
J	0.4	0.6
K	0.3	0.7
L	0.50 Typical	
P	—	2.3
All Dimensions in mm		

### Maximum Ratings and Electrical Characteristics @ $T_A=25^\circ\text{C}$ unless otherwise specified

Single Phase, half wave, 60Hz, resistive or inductive load. For capacitive load, derate current by 20%.

Characteristic	Symbol	SD 1020CS	SD 1030CS	SD 1040CS	SD 1050CS	SD 1060CS	SD 1080CS	SD 10100CS	Unit	
Peak Repetitive Reverse Voltage	$V_{RRM}$	20	30	40	50	60	80	100	V	
Working Peak Reverse Voltage	$V_{RWM}$									
DC Blocking Voltage	$V_R$									
RMS Reverse Voltage	$V_{R(RMS)}$	14	21	28	35	42	56	70	V	
Average Rectified Output Current @ $T_L = 100^\circ\text{C}$	$I_O$	10							A	
Non-Repetitive Peak Forward Surge Current 8.3ms Single half sine-wave superimposed on rated load (JEDEC Method)	$I_{FSM}$	100							A	
Forward Voltage (Note 1) @ $I_F = 5.0\text{A}$	$V_{FM}$	0.55			0.75		0.85		V	
Peak Reverse Current @ $T_A = 25^\circ\text{C}$ At Rated DC Blocking Voltage @ $T_A = 100^\circ\text{C}$	$I_{RM}$	0.2					50			mA
Typical Junction Capacitance (Note 2)	$C_j$	600							pF	
Typical Thermal Resistance Junction to Ambient	$R_{\theta JA}$	60							K/W	
Operating Temperature Range	$T_j$	-50 to +125							$^\circ\text{C}$	
Storage Temperature Range	$T_{STG}$	-50 to +150							$^\circ\text{C}$	

Note: 1. Mounted on P.C. Board with  $14\text{mm}^2$  (0.13mm thick) copper pad.  
2. Measured at 1.0 MHz and applied reverse voltage of 4.0V D.C.

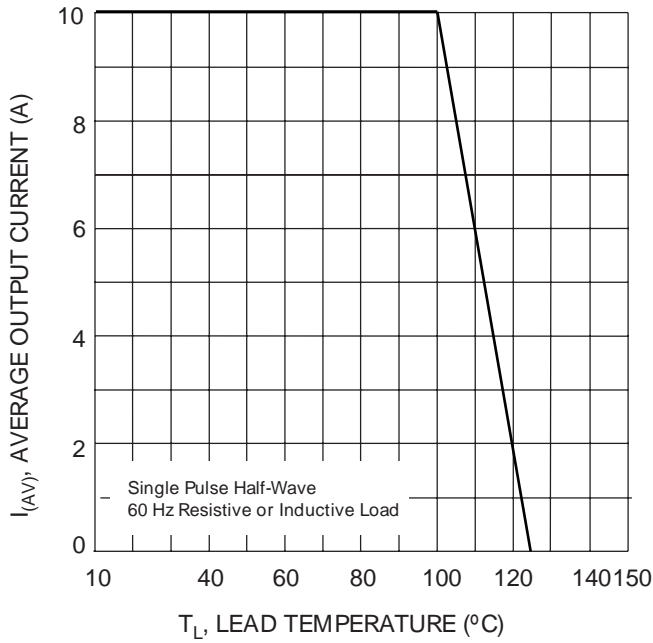

Fig. 1 Forward Current Derating Curve

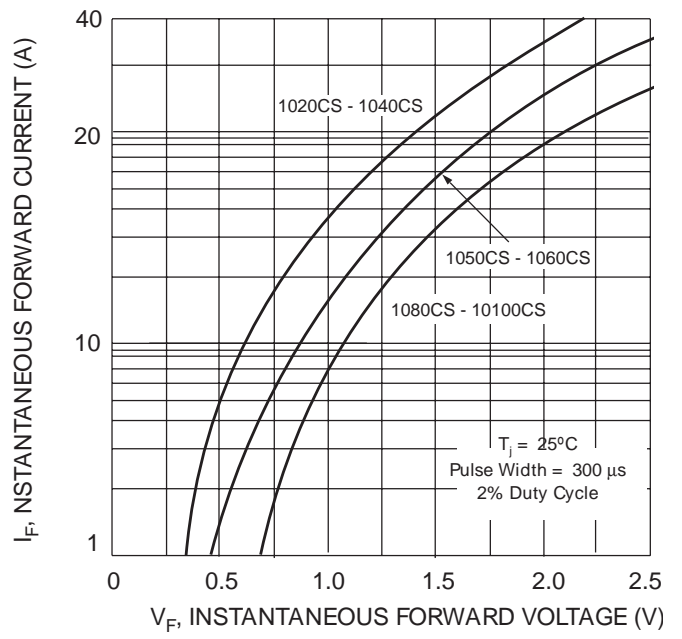

Fig. 2 Typical Forward Characteristics

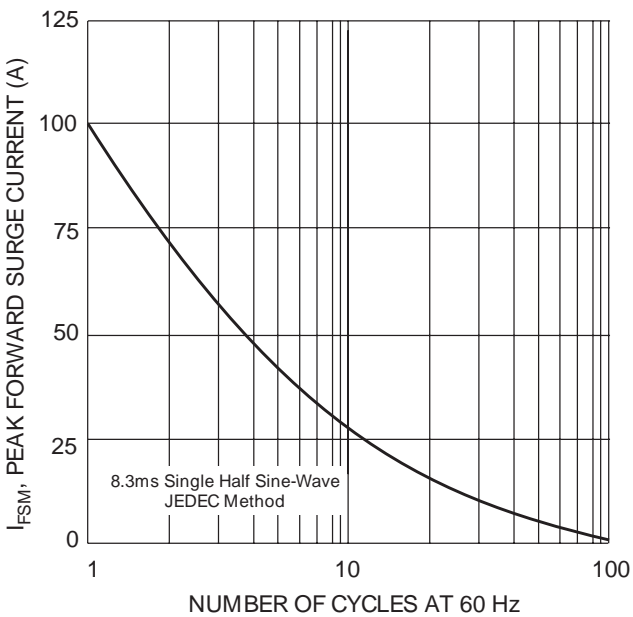

Fig. 3 Maximum Non-Repetitive Peak Fwd Surge Current

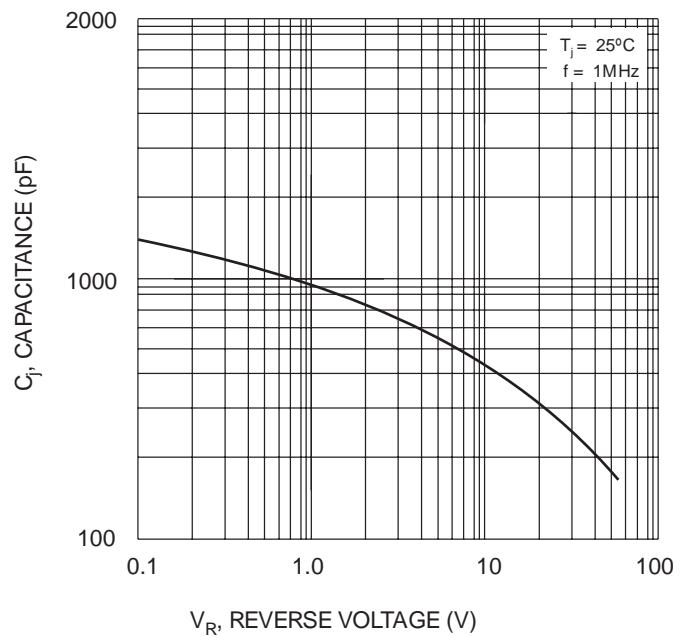

Fig. 4 Typical Junction Capacitance

## ORDERING INFORMATION

Product No.♦	Package Type	Shipping Quantity
SD1020CS-T3	DPAK	2500/Tape & Reel
SD1030CS-T3	DPAK	2500/Tape & Reel
SD1040CS-T3	DPAK	2500/Tape & Reel
SD1050CS-T3	DPAK	2500/Tape & Reel
SD1060CS-T3	DPAK	2500/Tape & Reel
SD1080CS-T3	DPAK	2500/Tape & Reel
SD10100CS-T3	DPAK	2500/Tape & Reel

♦T3 suffix refers to a 13" reel.

Shipping quantity given is for minimum packing quantity only. For minimum order quantity, please consult the Sales Department.

## RECOMMENDED FOOTPRINT

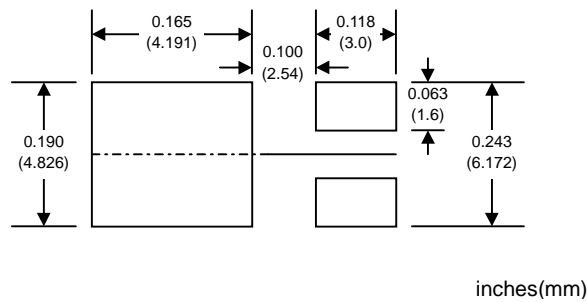

inches(mm)

Won-Top Electronics Co., Ltd (WTE) has checked all information carefully and believes it to be correct and accurate. However, WTE cannot assume any responsibility for inaccuracies. Furthermore, this information does not give the purchaser of semiconductor devices any license under patent rights to manufacturer. WTE reserves the right to change any or all information herein without further notice.

**WARNING:** DO NOT USE IN LIFE SUPPORT EQUIPMENT. WTE power semiconductor products are not authorized for use as critical components in life support devices or systems without the express written approval.

**Won-Top Electronics Co., Ltd.**

No. 44 Yu Kang North 3rd Road, Chine Chen Dist., Kaohsiung, Taiwan

**Phone:** 886-7-822-5408 or 886-7-822-5410

**Fax:** 886-7-822-5417

**Email:** sales@wontop.com

**Internet:** <http://www.wontop.com>

*We power your everyday.*