

STANDARD RECOVERY DIODES

Hockey Puk Version

Features

- Wide current range
- High voltage ratings up to 4500V
- High surge current capabilities
- Diffused junction
- Hockey Puk version
- Case style DO-200AC (K-PUK)

Typical Applications

- Converters
- Power supplies
- Machine tool controls
- High power drives
- Medium traction applications

2100A

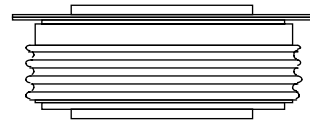

case style DO-200AC (K-PUK)

Major Ratings and Characteristics

Parameters	SD1700C..K		Units	
	24 to 36	40 to 45		
$I_{F(AV)}$	2080	1875	A	
@ T_{hs}	55	55	°C	
$I_{F(RMS)}$	3600	3280	A	
@ T_{hs}	25	25	°C	
I_{FSM}	@ 50Hz	24000	20000	A
	@ 60Hz	25150	20950	A
I^2t	@ 50Hz	2890	2000	KA ² s
	@ 60Hz	2630	1826	KA ² s
V_{RRM} range	2400 to 3600	4000 to 4500	V	
T_J	- 40 to 150	- 40 to 150	°C	

SD1700C..K Series

Bulletin I2087 rev. B 04/00

International
 Rectifier

ELECTRICAL SPECIFICATIONS

Voltage Ratings

Type number	Voltage Code	V_{RRM} , maximum repetitive peak reverse voltage V	V_{RSM} , maximum non-repetitive peak rev. voltage V	I_{RRM} max. @ $T_J = T_J$ max. mA
SD1700C..K	24	2400	2500	75
	30	3000	3100	
	36	3600	3700	
	40	4000	4100	
	45	4500	4600	

Forward Conduction

Parameter	SD1700C..K		Units	Conditions		
	24 to 36	40 to 45				
$I_{F(AV)}$ Max. average forward current @ Heatsink temperature	2080(1000)	1875(920)	A	180° conduction, half sine wave Double side (single side) cooled		
	55(85)	55(85)	°C			
$I_{F(RMS)}$ Max. RMS forward current	3600	3280	A	@ 25°C heatsink temperature double side cooled		
I_{FSM} Max. peak, one-cycle forward, non-repetitive surge current	24000	20000	A	t = 10ms	No voltage	Sinusoidal halfwave, Initial $T_J = T_J$ max.
	25150	20950		t = 8.3ms	reapplied	
	20200	16800		t = 10ms	50% V_{RRM}	
	21150	17600		t = 8.3ms	reapplied	
I^2t Maximum I^2t for fusing	2890	2000	KA ² s	t = 10ms	No voltage	
	2630	1826		t = 8.3ms	reapplied	
	2040	1415		t = 10ms	50% V_{RRM}	
	1860	1292		t = 8.3ms	reapplied	
$I^2\sqrt{t}$ Maximum $I^2\sqrt{t}$ for fusing	28900	20000	KA ² √s	t = 0.1 to 10ms, no voltage reapplied		
$V_{F(TO)1}$ Low level value of threshold voltage	0.89	0.88	V	(16.7% $\times \pi \times I_{F(AV)} < I < \pi \times I_{F(AV)}$), $T_J = T_J$ max.		
$V_{F(TO)2}$ High level value of threshold voltage	1.02	0.99		(I > $\pi \times I_{F(AV)}$), $T_J = T_J$ max.		
r_{f1} Low level value of forward slope resistance	0.23	0.31	mΩ	(16.7% $\times \pi \times I_{F(AV)} < I < \pi \times I_{F(AV)}$), $T_J = T_J$ max.		
r_{f2} High level value of forward slope resistance	0.21	0.29		(I > $\pi \times I_{F(AV)}$), $T_J = T_J$ max.		
V_{FM} Max. forward voltage drop	1.81	2.11	V	$I_{pk} = 4000A$, $T_J = T_J$ max, $t_p = 10ms$ sinusoidal wave		

Thermal and Mechanical Specifications

Parameter	SD1700C..K		Units	Conditions
	24 to 36	40 to 45		
T _J Max. junction operating temperature range	-40 to 150	-40 to 150	°C	
T _{stg} Max. storage temperature range	-55 to 200	-55 to 200		
R _{thJ-hs} Max. thermal resistance, junction to heatsink	0.042		K/W	DC operation single side cooled DC operation double side cooled
	0.020			
F Mounting force, ± 10%	22250 (2250)		N (Kg)	
wt Approximate weight	425		g	
Case style	DO-200AC (K-PUK)			See Outline Table

ΔR_{thJ-hs} Conduction

(The following table shows the increment of thermal resistance R_{thJ-hs} when devices operate at different conduction angles than DC)

Conduction angle	Sinusoidal conduction		Rectangular conduction		Units	Conditions
	Single Side	Double Side	Single Side	Double Side		
180°	0.002	0.002	0.001	0.001	K/W	T _J = T _J max.
120°	0.002	0.002	0.002	0.002		
90°	0.003	0.003	0.003	0.003		
60°	0.004	0.004	0.004	0.004		
30°	0.007	0.007	0.007	0.007		

Ordering Information Table

Device Code

SD	170	0	C	45	K
①	②	③	④	⑤	⑥

- 1** - Diode
- 2** - Essential part number
- 3** - 0 = Standard recovery
- 4** - C = Ceramic Puk
- 5** - Voltage code: Code x 100 = V_{RRM} (See Voltage Ratings table)
- 6** - K = Puk Case DO-200AC (K-PUK)

SD1700C..K Series

Bulletin I2087 rev. B 04/00

International
IRF Rectifier

Outline Table

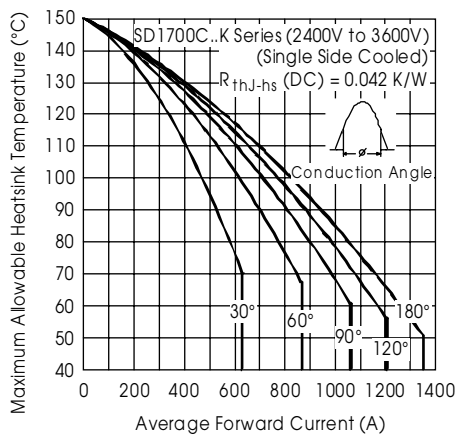
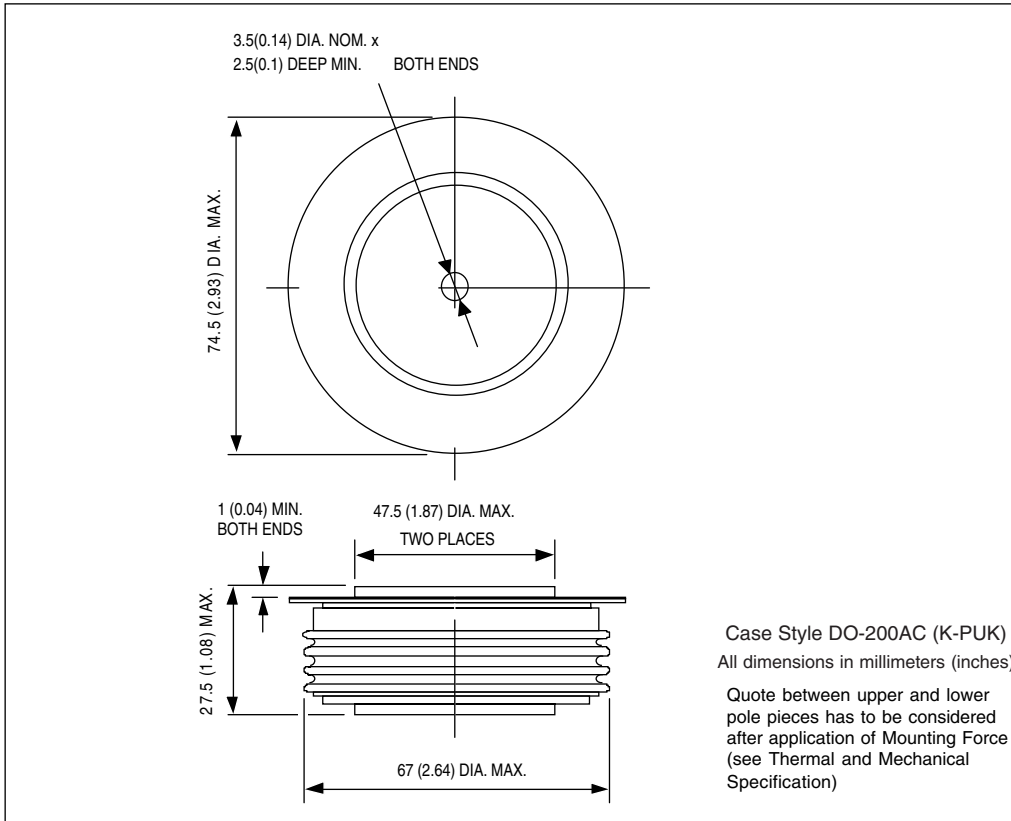

Fig. 1 - Current Ratings Characteristics

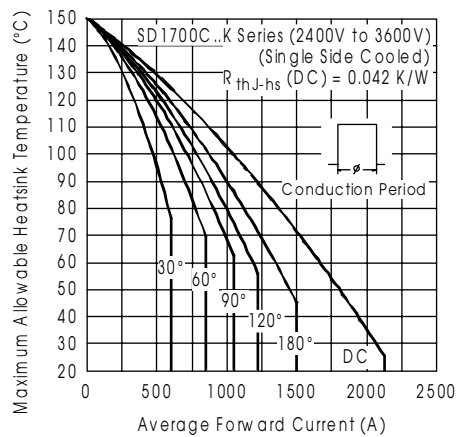

Fig. 2 - Current Ratings Characteristics

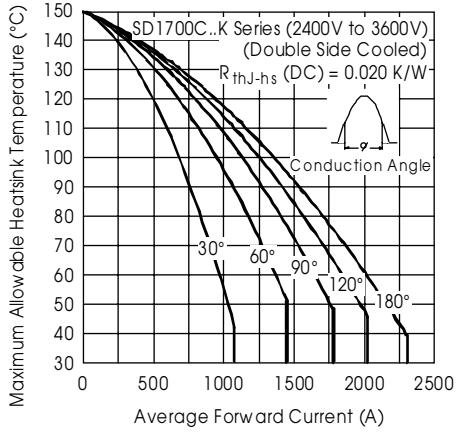

Fig. 3 - Current Ratings Characteristics

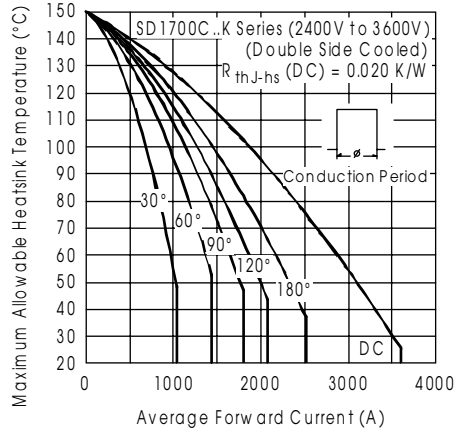

Fig. 4 - Current Ratings Characteristics

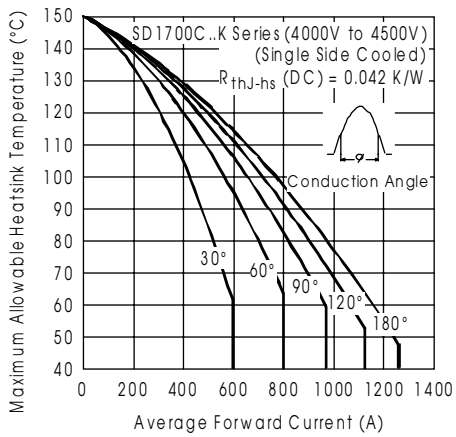

Fig. 5 - Current Ratings Characteristics

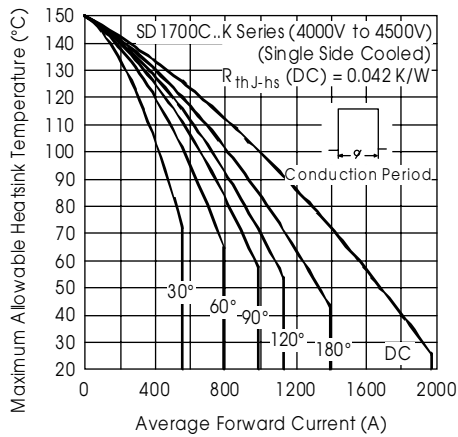

Fig. 6 - Current Ratings Characteristics

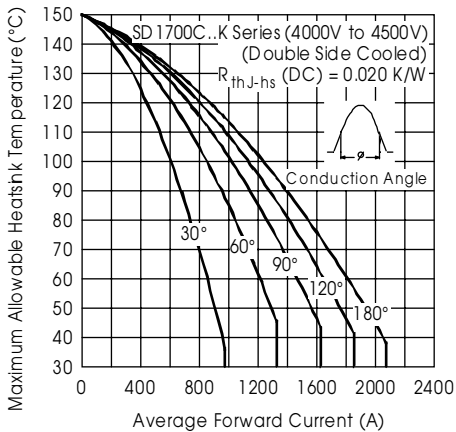

Fig. 7 - Current Ratings Characteristics

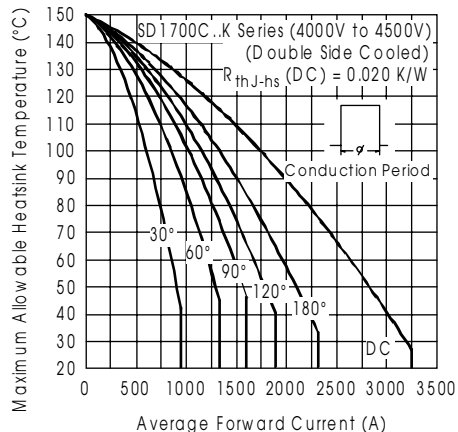

Fig. 8 - Current Ratings Characteristics

SD1700C..K Series

Bulletin I2087 rev. B 04/00

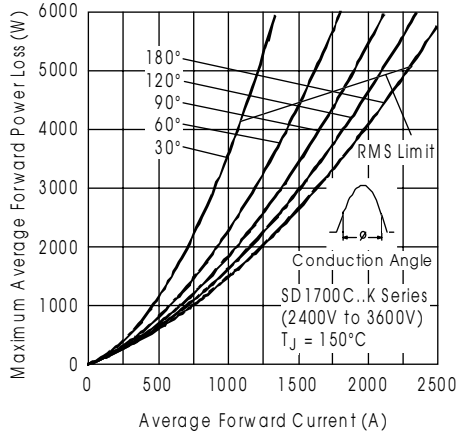

Fig. 9 - Forward Power Loss Characteristics

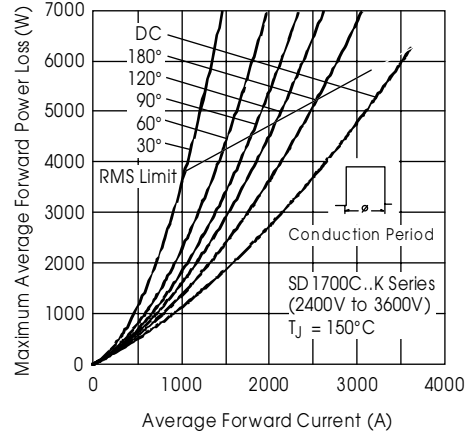

Fig. 10 - Forward Power Loss Characteristics

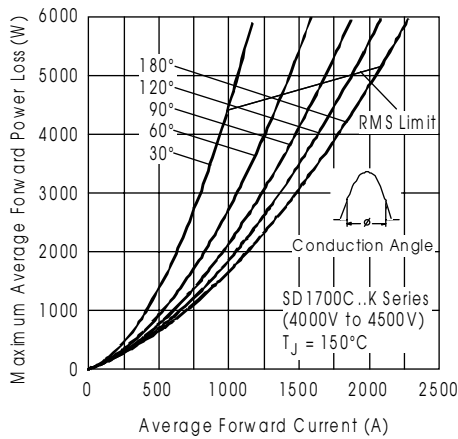

Fig. 11 - Forward Power Loss Characteristics

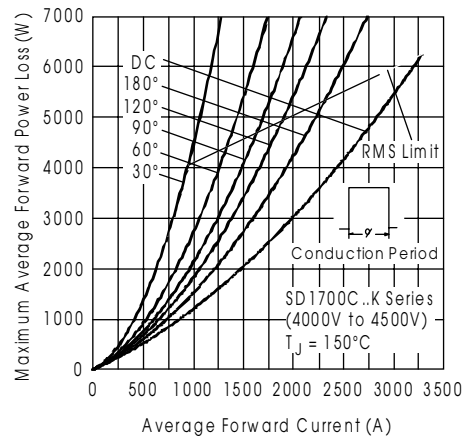

Fig. 12 - Forward Power Loss Characteristics

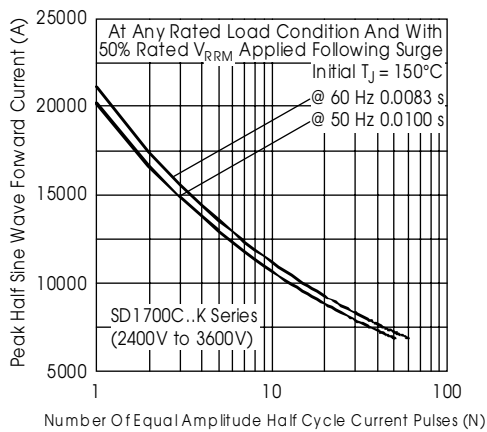

Fig. 13 - Maximum Non-Repetitive Surge Current
Single and Double Side Cooled

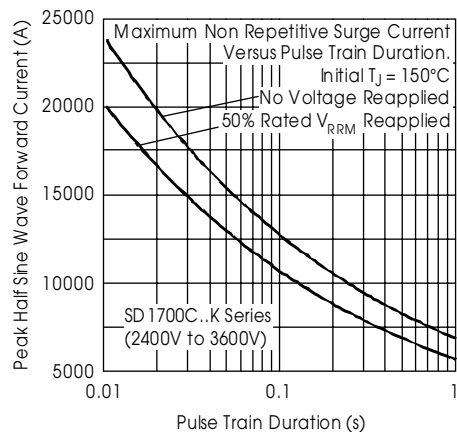

Fig. 14 - Maximum Non-Repetitive Surge Current
Single and Double Side Cooled

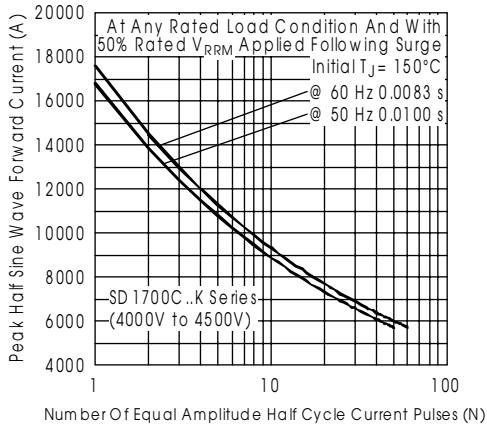

Fig. 15 - Maximum Non-Repetitive Surge Current Single and Double Side Cooled

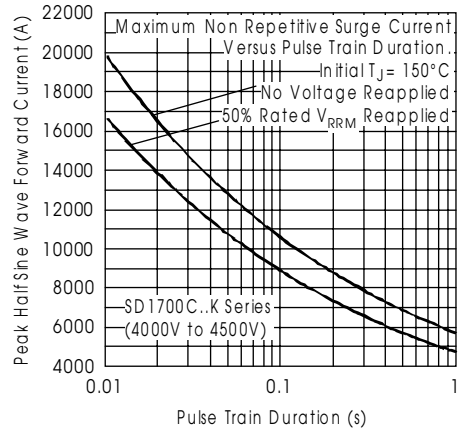

Fig. 16 - Maximum Non-Repetitive Surge Current Single and Double Side Cooled

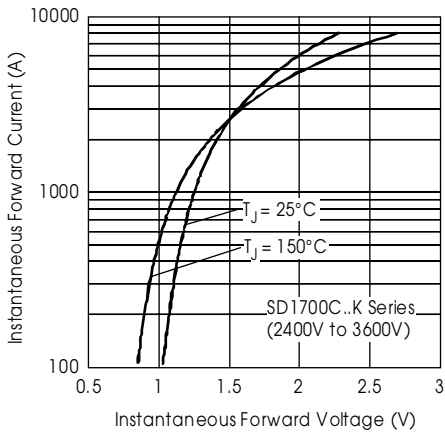

Fig. 17 - Forward Voltage Drop Characteristics

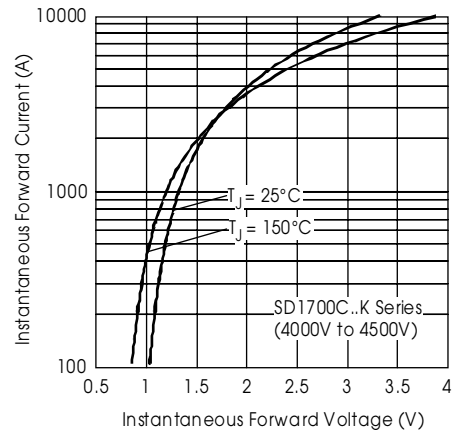

Fig. 18 - Forward Voltage Drop Characteristics

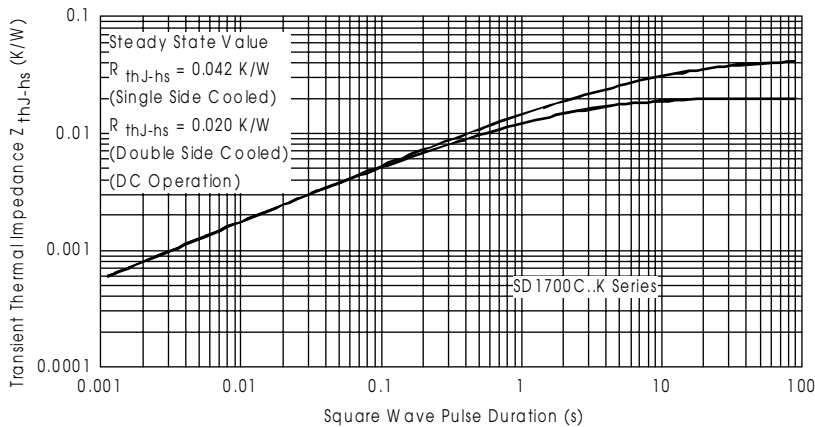

Fig. 19 - Thermal Impedance Z_{thJC} Characteristics