

FAST RECOVERY DIODES

Stud Version

Features

- High power FAST recovery diode series
- 1.0 to 2.0 μ s recovery time
- High voltage ratings up to 2500V
- High current capability
- Optimized turn on and turn off characteristics
- Low forward recovery
- Fast and soft reverse recovery
- Compression bonded encapsulation
- Stud version JEDEC DO-205AB (DO-9)
- Maximum junction temperature 125°C

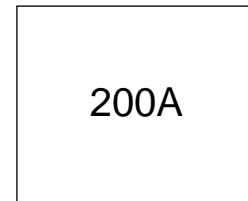

Typical Applications

- Snubber diode for GTO
- High voltage free-wheeling diode
- Fast recovery rectifier applications

Major Ratings and Characteristics

Parameters	SD203N/R	Units
$I_{F(AV)}$	200	A
@ T_C	85	°C
$I_{F(RMS)}$	314	A
I_{FSM} @ 50Hz	4990	A
@ 60Hz	5230	A
I^2t @ 50Hz	125	KA ² s
@ 60Hz	114	KA ² s
V_{RRM} range	400 to 2500	V
t_{rr} range	1.0 to 2.0	μ s
@ T_J	25	°C
T_J	- 40 to 125	°C

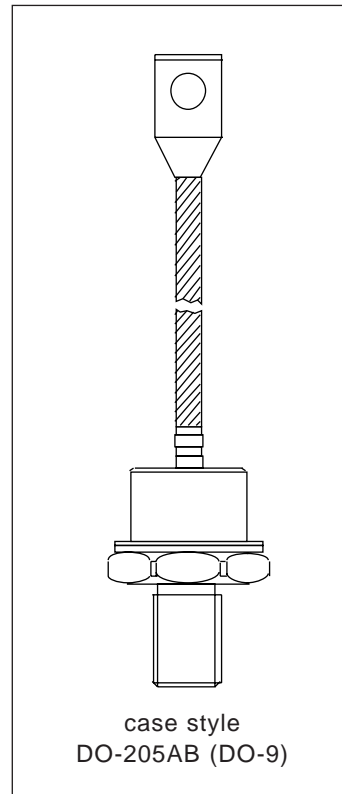

SD203N/R Series

Bulletin I2064 rev. A 09/94

International
IR Rectifier

ELECTRICAL SPECIFICATIONS

Voltage Ratings

Type number	Voltage Code	V_{RRM} max. repetitive peak and off-state voltage V	V_{RSM} , maximum non-repetitive peak voltage V	I_{RRM} max. $T_J = 125^\circ\text{C}$ mA
SD203N/R..S10	04	400	500	35
	08	800	900	
	10	1000	1100	
SD203N/R..S15	12	1200	1300	
	14	1400	1500	
	16	1600	1700	
SD203N/R..S20	20	2000	2100	
	25	2500	2600	

Forward Conduction

Parameter	SD203N/R	Units	Conditions
$I_{F(AV)}$ Max. average forward current @ Case temperature	200	A	180° conduction, half sine wave.
	85	°C	
$I_{F(RMS)}$ Max. RMS current	314	A	DC @ 76°C case temperature
I_{FSM} Max. peak, one-cycle non-repetitive forward current	4990	A	t = 10ms No voltage
	5230		t = 8.3ms reapplied
	4200		t = 10ms 100% V_{RRM}
	4400		t = 8.3ms reapplied
I^2t Maximum I^2t for fusing	125	KA ² s	t = 10ms No voltage
	114		t = 8.3ms reapplied
	88		t = 10ms 100% V_{RRM}
	81		t = 8.3ms reapplied
$I^2\sqrt{t}$ Maximum $I^2\sqrt{t}$ for fusing	1250	KA ² √s	t = 0.1 to 10ms, no voltage reapplied
$V_{F(TO)1}$ Low level of threshold voltage	1.00	V	(16.7% $\times \pi \times I_{F(AV)} < I < \pi \times I_{F(AV)}$), $T_J = T_J$ max.
$V_{F(TO)2}$ High level of threshold voltage	1.47		($I > \pi \times I_{F(AV)}$), $T_J = T_J$ max.
r_{f1} Low level of forward slope resistance	1.10	mΩ	(16.7% $\times \pi \times I_{F(AV)} < I < \pi \times I_{F(AV)}$), $T_J = T_J$ max.
r_{f2} High level of forward slope resistance	0.46		($I > \pi \times I_{F(AV)}$), $T_J = T_J$ max.
V_{FM} Max. forward voltage	1.65	V	$I_{pk} = 628\text{A}$, $T_J = 25^\circ\text{C}$, $t_p = 400 \mu\text{s}$ square pulse

Recovery Characteristics

Code	$T_J = 25^\circ\text{C}$ typical t_{rr} @ 25% I_{RRM} (μs)	Test conditions			Max. values @ $T_J = 125^\circ\text{C}$		
		I_{pk} Square Pulse (A)	di/dt (A/μs)	V_r (V)	t_{rr} @ 25% I_{RRM} (μs)	Q_{rr} (μC)	I_{rr} (A)
S10	1.0	750	25	-30	2.4	52	33
S15	1.5				2.9	90	44
S20	2.0				3.2	107	46

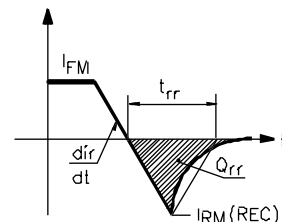

Thermal and Mechanical Specification

Parameter	SD203N/R	Units	Conditions
T _J Max. operating temperature range	-40 to 125	°C	
T _{stg} Max. storage temperature range	-40 to 150		
R _{thJC} Max. thermal resistance, junction to case	0.115	K/W	DC operation
R _{thCS} Max. thermal resistance, case to heatsink	0.08		Mounting surface, smooth, flat and greased
T Mounting torque ±10%	31	Nm	Not lubricated threads
	24.5		Lubricated threads
wt Approximate weight	250	g	
Case style	DO-205AB (DO-9)		See Outline Table

ΔR_{thJC} Conduction

(The following table shows the increment of thermal resistance R_{thJC} when devices operate at different conduction angles than DC)

Conduction angle	Sinusoidal conduction	Rectangular conduction	Units	Conditions
180°	0.010	0.008	K/W	T _J = T _J max.
120°	0.013	0.014		
90°	0.017	0.019		
60°	0.025	0.027		
30°	0.044	0.044		

Ordering Information Table

Device Code

SD	20	3	R	25	S20	P	B	C
①	②	③	④	⑤	⑥	⑦	⑧	⑨

- 1** - Diode
- 2** - Essential part number
- 3** - 3 = Fast recovery
- 4** - N = Stud Normal Polarity (Cathode to Stud)
R = Stud Reverse Polarity (Anode to Stud)
- 5** - Voltage code: Code x 100 = V_{RRM} (see Voltage Ratings table)
- 6** - t_{rr} code (see Recovery Characteristics table)
- 7** - P = Stud base DO-205AB (DO-9) 3/4" 16UNF-2A
M = Stud base DO-205AB (DO-9) M16 X 1.5
- 8** - B = Flag top terminals (for Cathode/ Anode Leads)
S = Isolated lead with silicone sleeve
(Red = Reverse Polarity; Blue = Normal Polarity)
None = Not isolated lead
- 9** - C = Ceramic housing (over 1600V)
V = Glass-metal seal (only up to 1600V)

SD203N/R Series

Bulletin I2064 rev. A 09/94

Outline Table

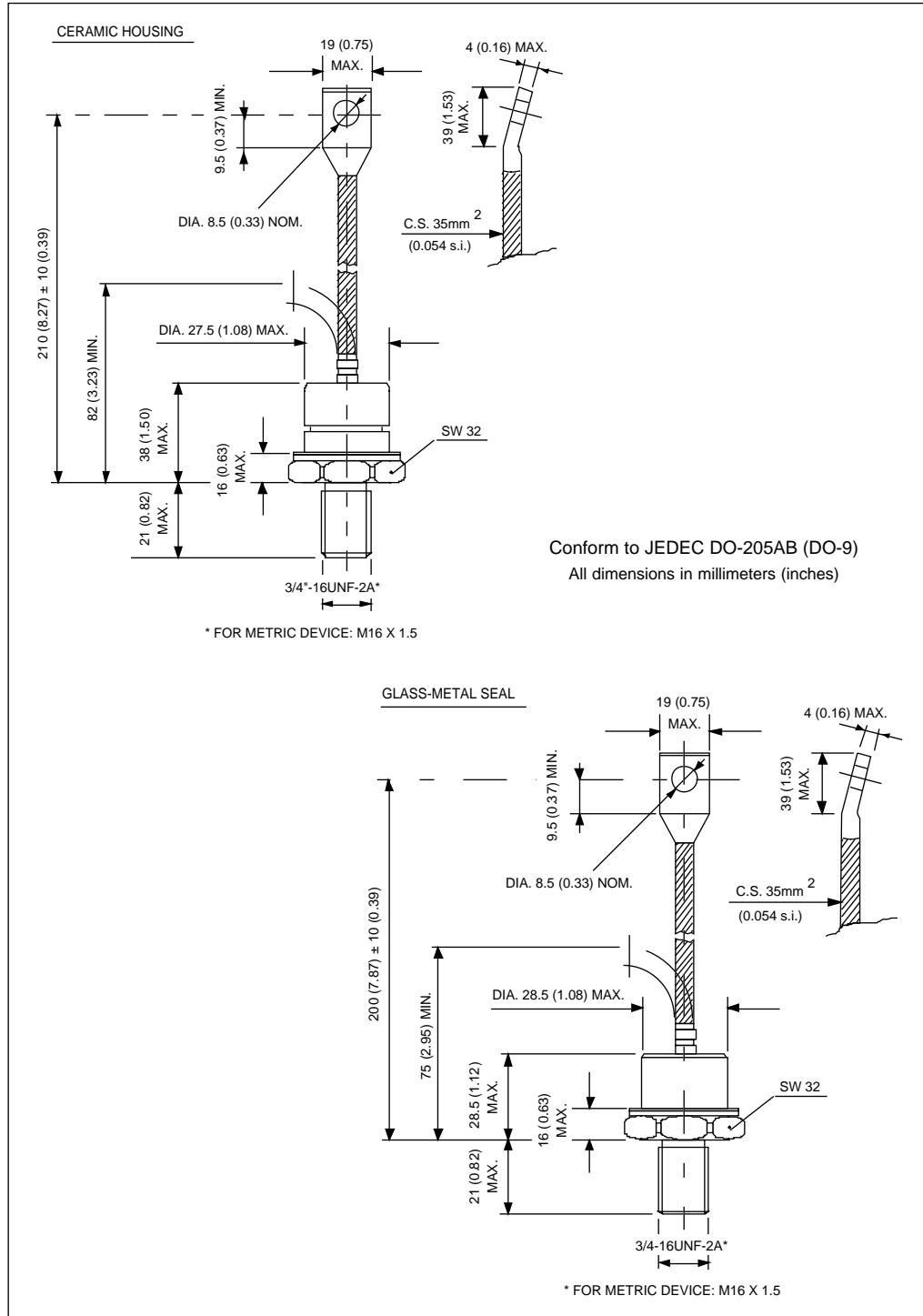

Outline Table

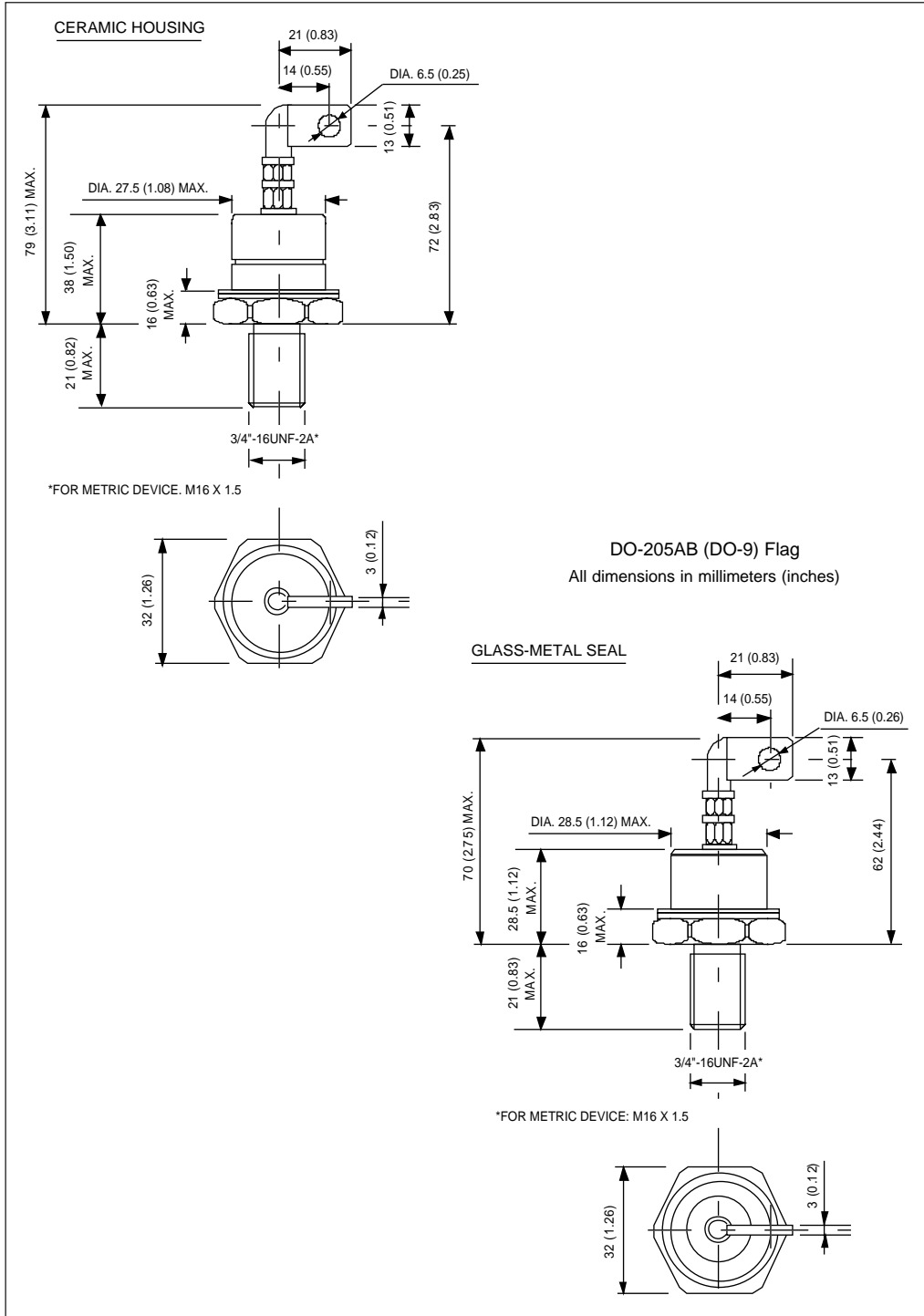

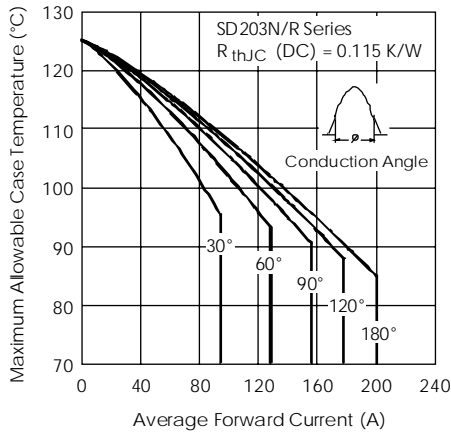

Fig. 1 - Current Ratings Characteristics

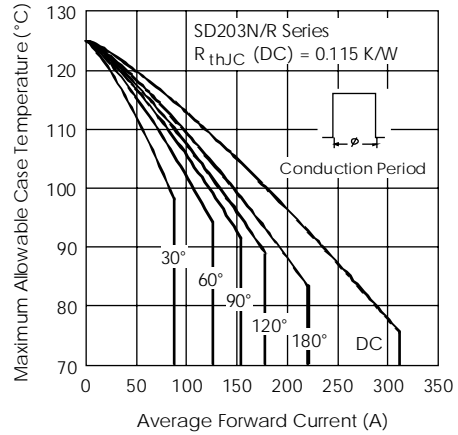

Fig. 2 - Current Ratings Characteristics

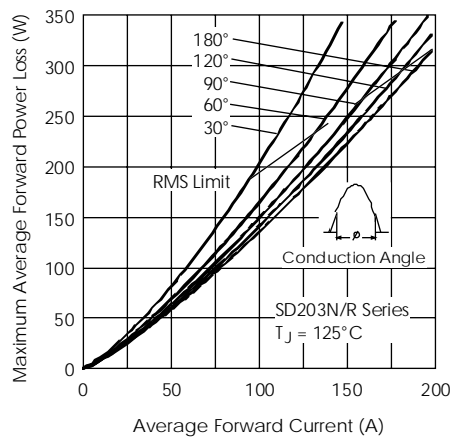

Fig. 3 - Forward Power Loss Characteristics

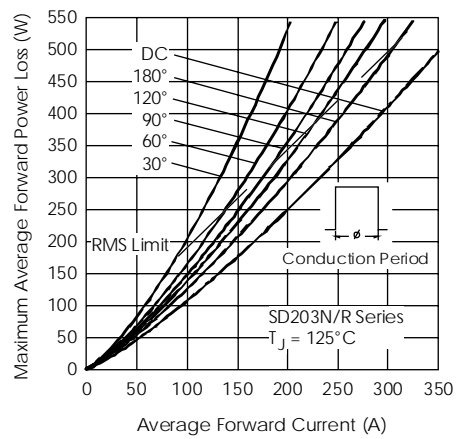

Fig. 4 - Forward Power Loss Characteristics

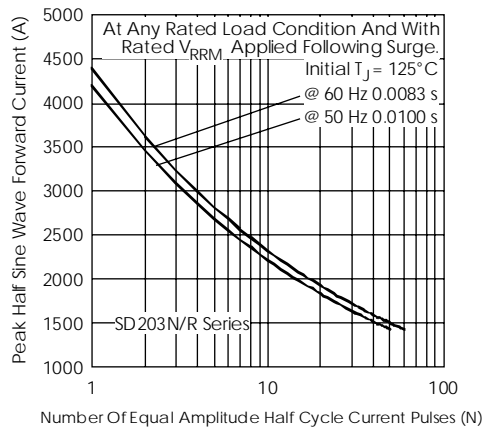

Fig. 5 - Maximum Non-repetitive Surge Current

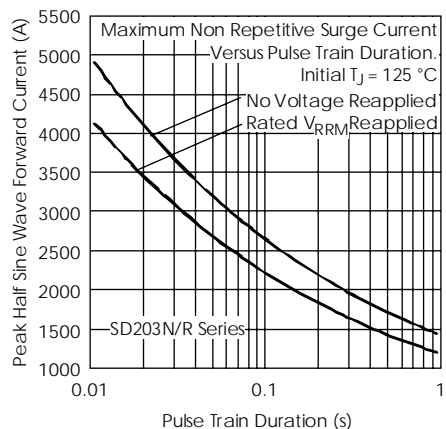

Fig. 6 - Maximum Non-repetitive Surge Current

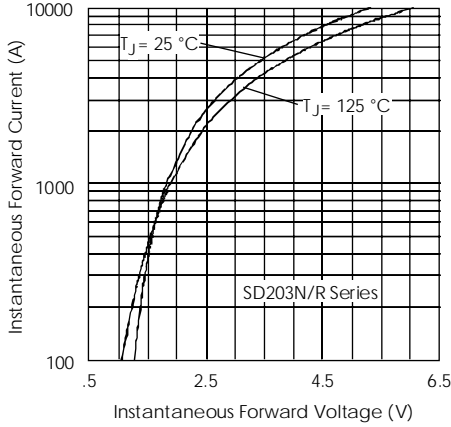

Fig. 7 - Forward Voltage Drop Characteristics

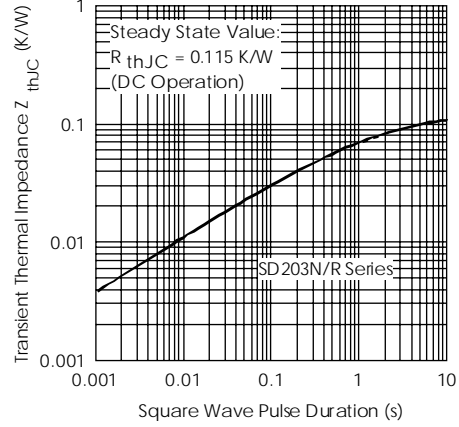

Fig. 8 - Thermal Impedance Z_{thJC} Characteristic

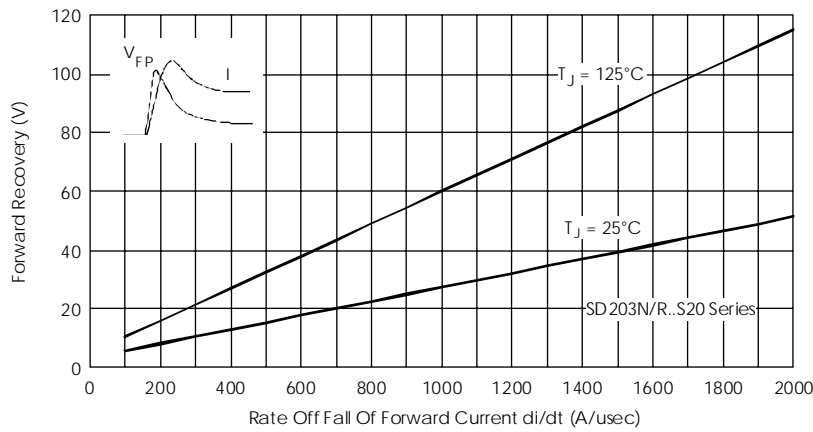

Fig. 9 - Typical Forward Recovery Characteristics

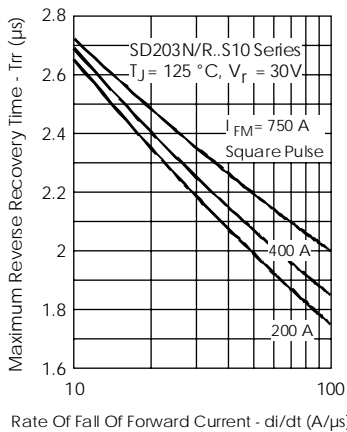

Fig. 10 - Recovery Time Characteristics

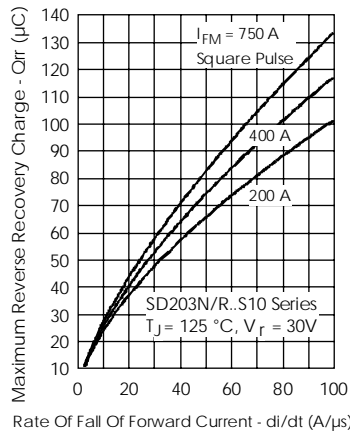

Fig. 11 - Recovery Charge Characteristics

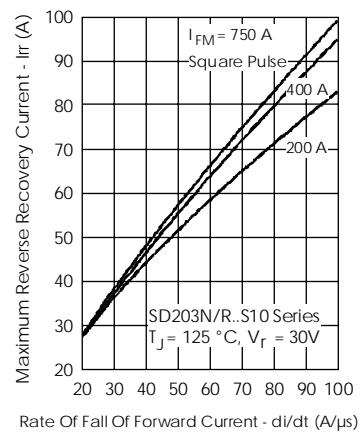

Fig. 12 - Recovery Current Characteristics

SD203N/R Series

Bulletin I2064 rev. A 09/94

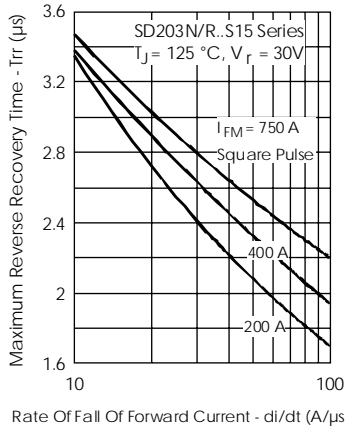

Fig. 13 - Recovery Time Characteristics

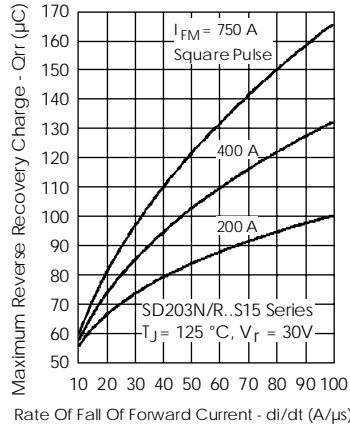

Fig. 14 - Recovery Charge Characteristics

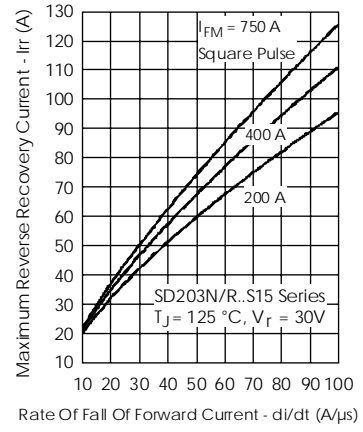

Fig. 15 - Recovery Current Characteristics

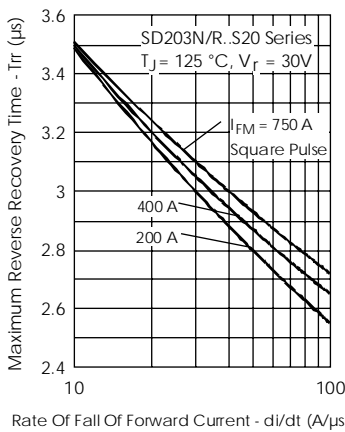

Fig. 16 - Recovery Time Characteristics

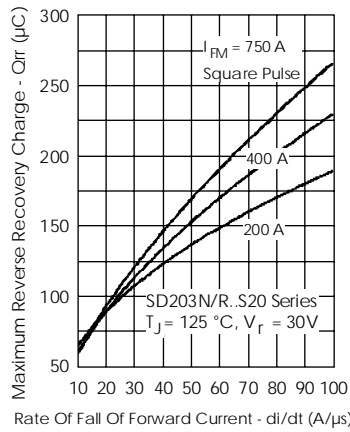

Fig. 17 - Recovery Charge Characteristics

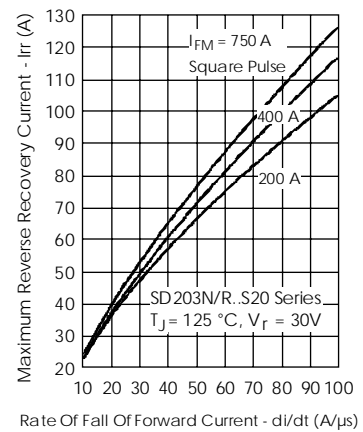

Fig. 18 - Recovery Current Characteristics

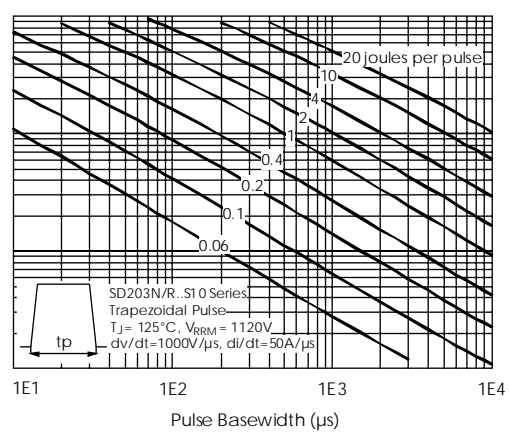
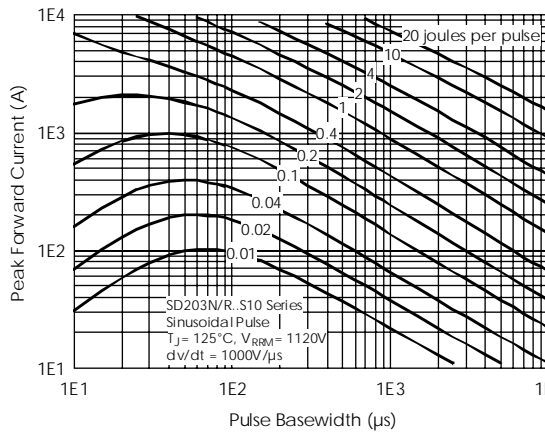

Fig. 19 - Maximum Total Energy Loss Per Pulse Characteristics

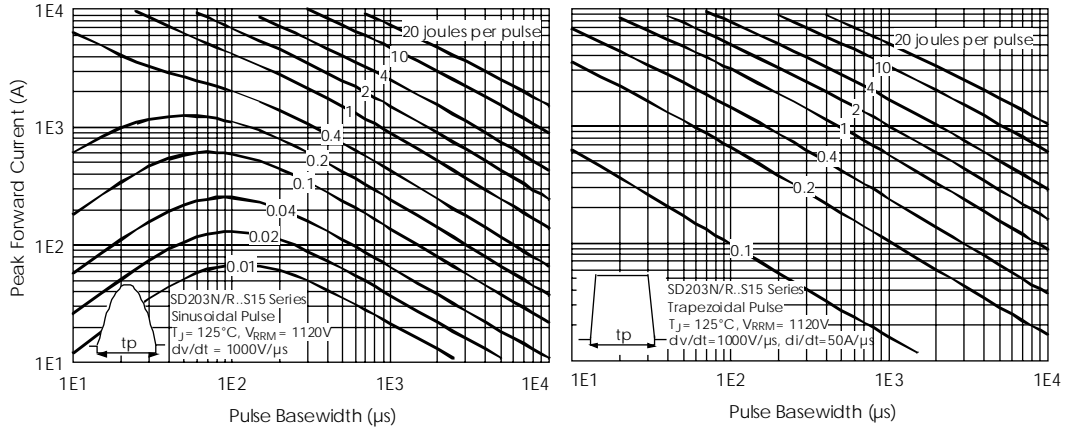

Fig. 20 - Maximum Total Energy Loss Per Pulse Characteristics

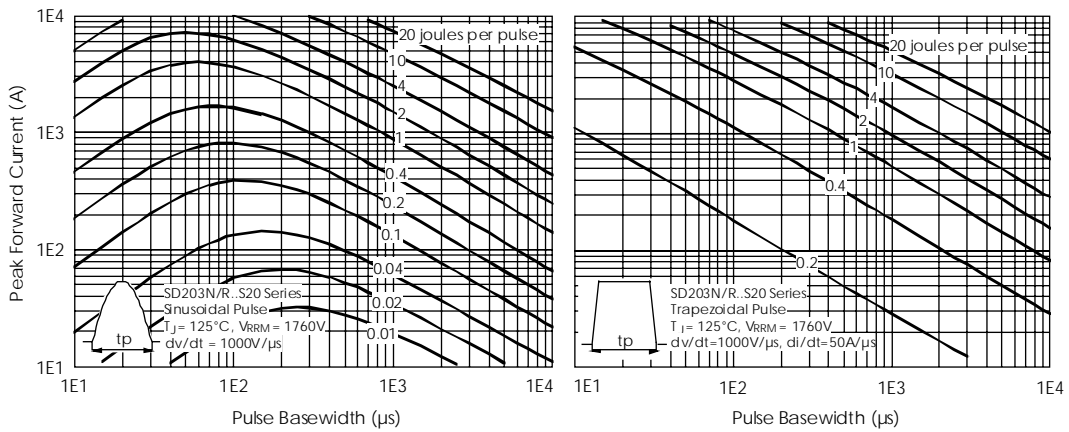

Fig. 21 - Maximum Total Energy Loss Per Pulse Characteristics