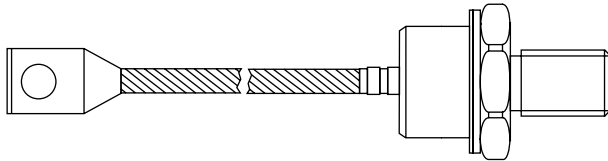

## Fast Recovery Diodes (Stud Version), 200 A

**DO-205AB (DO-9)**
**FEATURES**

- High power fast recovery diode series
- 1.0 to 2.0  $\mu\text{s}$  recovery time
- High voltage ratings up to 2500 V
- High current capability
- Optimized turn-on and turn-off characteristics
- Low forward recovery
- Fast and soft reverse recovery
- Compression bonded encapsulation
- Stud version JEDEC DO-205AB (DO-9)
- Maximum junction temperature 125 °C
- RoHS compliant
- Lead (Pb)-free
- Designed and qualified for industrial level

**RoHS  
COMPLIANT**
**PRODUCT SUMMARY**

$I_{F(AV)}$	200 A
-------------	-------

**TYPICAL APPLICATIONS**

- Snubber diode for GTO
- High voltage freewheeling diode
- Fast recovery rectifier applications

**MAJOR RATINGS AND CHARACTERISTICS**

PARAMETER	TEST CONDITIONS	VALUES	UNITS
$I_{F(AV)}$		200	A
	$T_C$	85	°C
$I_{F(RMS)}$		314	A
$I_{FSM}$	50 Hz	4990	
	60 Hz	5230	
$I^2t$	50 Hz	125	kA <sup>2</sup> s
	60 Hz	114	
$V_{RRM}$	Range	400 to 2500	V
$t_{rr}$	Range	1.0 to 2.0	$\mu\text{s}$
	$T_J$	25	°C
$T_J$		- 40 to 125	

**ELECTRICAL SPECIFICATIONS**

<b>VOLTAGE RATINGS</b>				
TYPE NUMBER	VOLTAGE CODE	$V_{RRM}$ , MAXIMUM REPETITIVE PEAK AND OFF-STATE VOLTAGE V	$V_{RSM}$ , MAXIMUM NON-REPETITIVE PEAK VOLTAGE V	$I_{RRM}$ MAXIMUM $T_J = 125\text{ }^\circ\text{C}$ mA
SD203N/R..S10	04	400	500	35
	08	800	900	
	10	1000	1100	
SD203N/R..S15	12	1200	1300	
	14	1400	1500	
	16	1600	1700	
SD203N/R..S20	20	2000	2100	
	25	2500	2600	

<b>FORWARD CONDUCTION</b>					
PARAMETER	SYMBOL	TEST CONDITIONS		VALUES	UNITS
Maximum average forward current at case temperature	$I_{F(AV)}$	180° conduction, half sine wave		200	A
				85	°C
Maximum RMS current	$I_{F(RMS)}$	DC at 76 °C case temperature		314	A
Maximum peak, one-cycle non-repetitive forward current	$I_{FSM}$	t = 10 ms	No voltage reapplied	4990	
		t = 8.3 ms	No voltage reapplied	5230	
		t = 10 ms	100 % $V_{RRM}$ reapplied	4200	
		t = 8.3 ms	100 % $V_{RRM}$ reapplied	4400	
Maximum $I^2t$ for fusing	$I^2t$	t = 10 ms	No voltage reapplied	125	kA <sup>2</sup> s
		t = 8.3 ms	No voltage reapplied	114	
		t = 10 ms	100 % $V_{RRM}$ reapplied	88	
		t = 8.3 ms	100 % $V_{RRM}$ reapplied	81	
Maximum $I^2\sqrt{t}$ for fusing	$I^2\sqrt{t}$	t = 0.1 to 10 ms, no voltage reapplied		1250	kA <sup>2</sup> √s
Low level value of threshold voltage	$V_{F(TO)1}$	(16.7 % $\times \pi \times I_{F(AV)} < I < \pi \times I_{F(AV)}$ ), $T_J = T_J$ maximum		1.00	V
High level value of threshold voltage	$V_{F(TO)2}$	(I > $\pi \times I_{F(AV)}$ ), $T_J = T_J$ maximum		1.47	
Low level value of forward slope resistance	$r_{f1}$	(16.7 % $\times \pi \times I_{F(AV)} < I < \pi \times I_{F(AV)}$ ), $T_J = T_J$ maximum		1.10	mΩ
High level value of forward slope resistance	$r_{f2}$	(I > $\pi \times I_{F(AV)}$ ), $T_J = T_J$ maximum		0.46	
Maximum forward voltage drop	$V_{FM}$	$I_{pk} = 628\text{ A}$ , $T_J = 25\text{ }^\circ\text{C}$ , $t_p = 400\text{ }\mu\text{s}$ square pulse		1.65	V

RECOVERY CHARACTERISTICS							
CODE	MAXIMUM VALUE AT $T_J = 25\text{ }^\circ\text{C}$	TEST CONDITIONS			TYPICAL VALUES AT $T_J = 125\text{ }^\circ\text{C}$		
	$t_{rr}$ AT 25 % $I_{RRM}$ ( $\mu\text{s}$ )	$I_{pk}$ SQUARE PULSE (A)	$dI/dt$ (A/ $\mu\text{s}$ )	$V_r$ (V)	$t_{rr}$ AT 25 % $I_{RRM}$ ( $\mu\text{s}$ )	$Q_{rr}$ ( $\mu\text{C}$ )	$I_{rr}$ (A)
S10	1.0	750	25	- 30	2.4	52	33
S15	1.5				2.9	90	44
S20	2.0				3.2	107	46

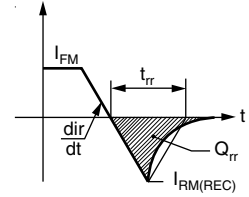

THERMAL AND MECHANICAL SPECIFICATIONS				
PARAMETER	SYMBOL	TEST CONDITIONS	VALUES	UNITS
Maximum operating temperature range	$T_J$		- 40 to 125	$^\circ\text{C}$
Maximum storage temperature range	$T_{Stg}$		- 40 to 150	
Maximum thermal resistance, junction to case	$R_{thJC}$	DC operation	0.115	K/W
Maximum thermal resistance, case to heatsink	$R_{thCS}$	Mounting surface, smooth, flat and greased	0.08	
Mounting torque $\pm 10\%$		Not-lubricated threads	31	Nm
		Lubricated threads	24.5	
Approximate weight			250	g
Case style		See dimensions (link at the end of datasheet)	DO-205AB (DO-9)	

$\Delta R_{thJC}$ CONDUCTION				
CONDUCTION ANGLE	SINUSOIDAL CONDUCTION	RECTANGULAR CONDUCTION	TEST CONDITIONS	UNITS
180 $^\circ$	0.010	0.008	$T_J = T_J$ maximum	K/W
120 $^\circ$	0.013	0.014		
90 $^\circ$	0.017	0.019		
60 $^\circ$	0.025	0.027		
30 $^\circ$	0.044	0.044		

**Note**

- The table above shows the increment of thermal resistance  $R_{thJC}$  when devices operate at different conduction angles than DC

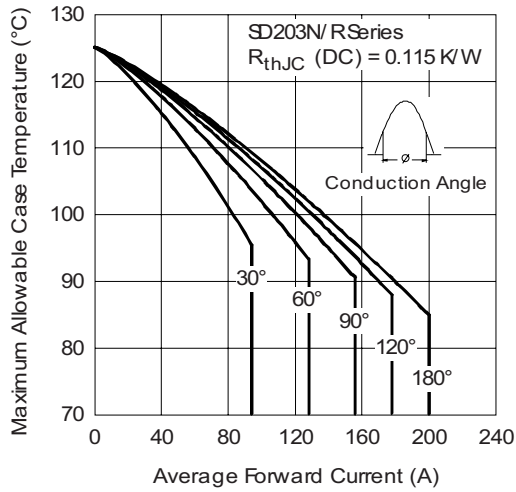

Fig. 1 - Current Ratings Characteristics

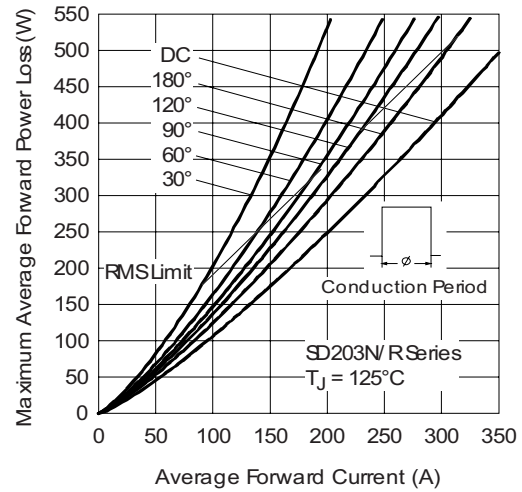

Fig. 4 - Forward Power Loss Characteristics

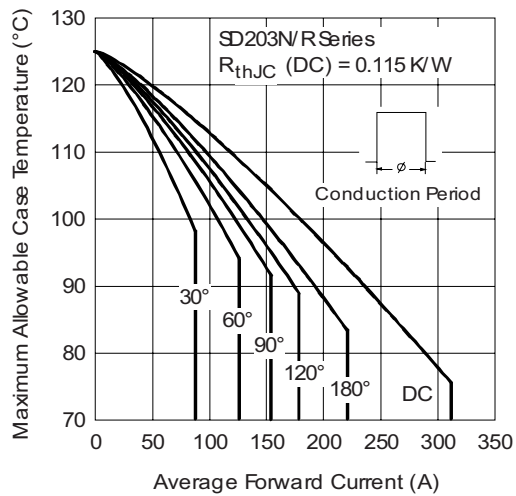

Fig. 2 - Current Ratings Characteristics

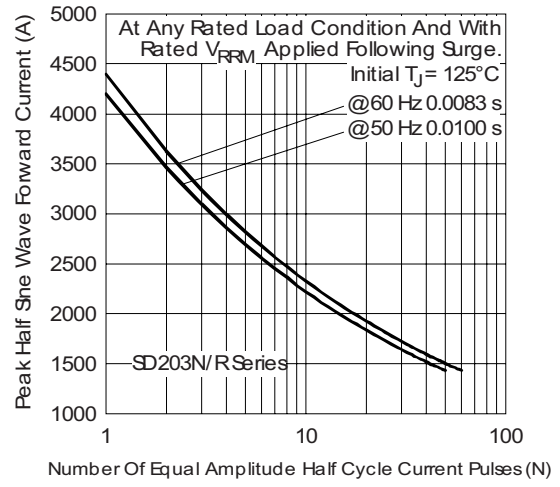

Fig. 5 - Maximum Non-Repetitive Surge Current

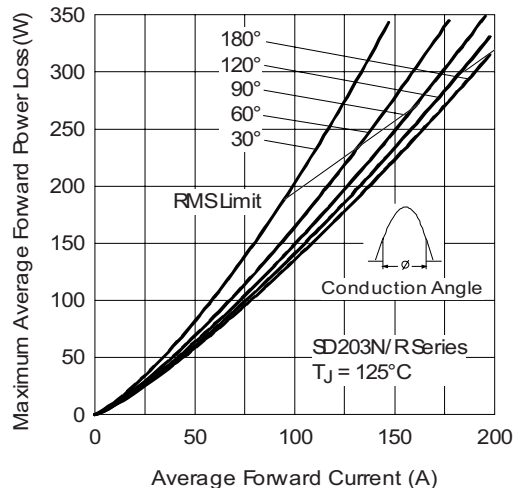

Fig. 3 - Forward Power Loss Characteristics

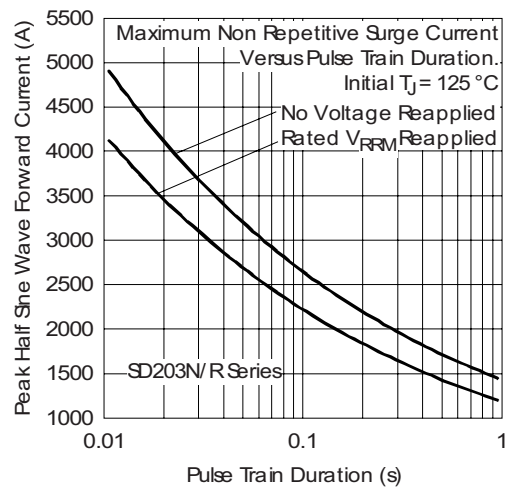

Fig. 6 - Maximum Non-Repetitive Surge Current



Fast Recovery Diodes  
(Stud Version), 200 A

SD203N/R Series

Vishay High Power Products

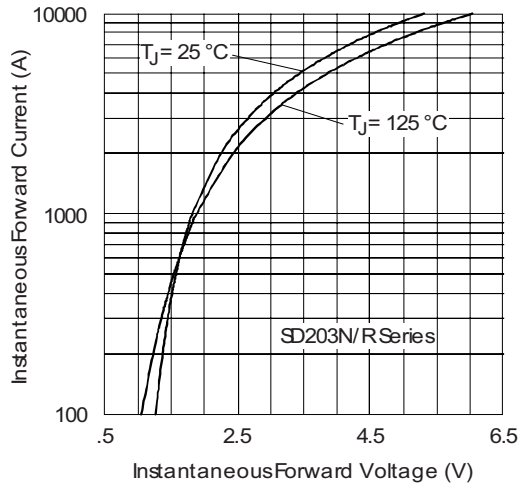

Fig. 7 - Forward Voltage Drop Characteristics

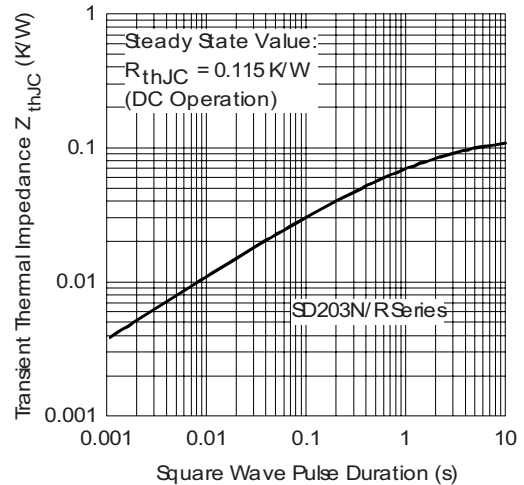

Fig. 8 - Thermal Impedance  $Z_{thJC}$  Characteristic

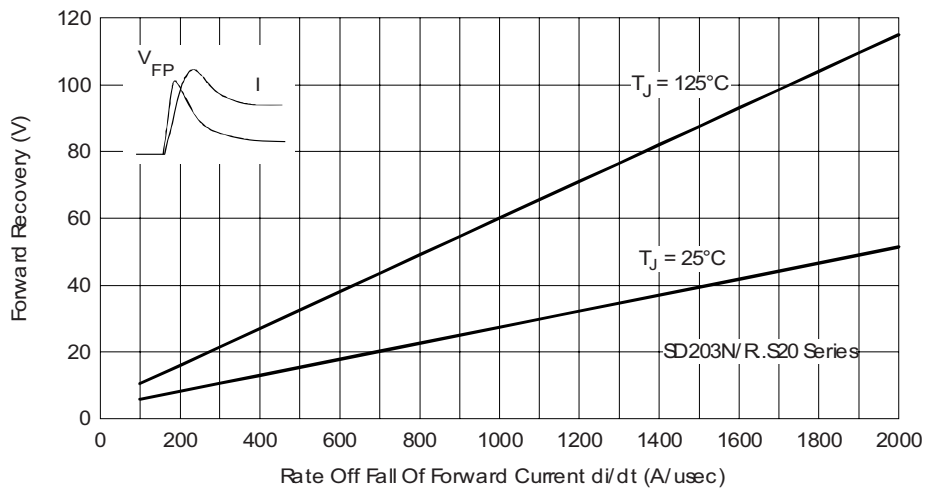

Fig. 9 - Typical Forward Recovery Characteristics

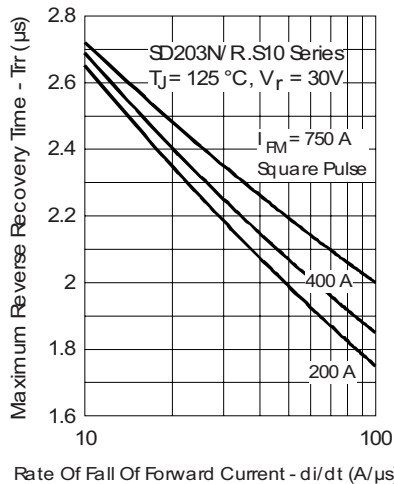

Fig. 10 - Recovery Time Characteristics

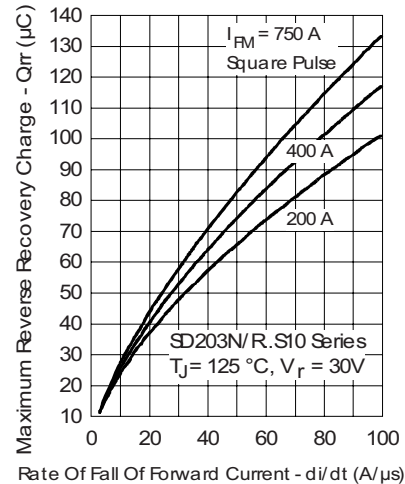
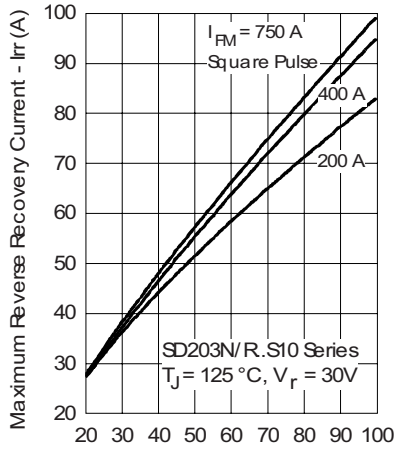
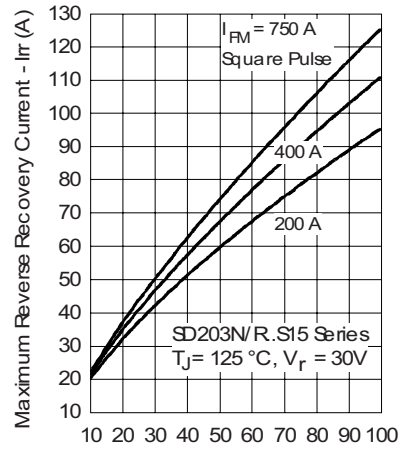

Fig. 11 - Recovery Charge Characteristics



Rate Of Fall Of Forward Current -  $di/dt$  (A/ $\mu$ s)  
Fig. 12 - Recovery Current Characteristics



Rate Of Fall Of Forward Current -  $di/dt$  (A/ $\mu$ s)  
Fig. 15 - Recovery Current Characteristics

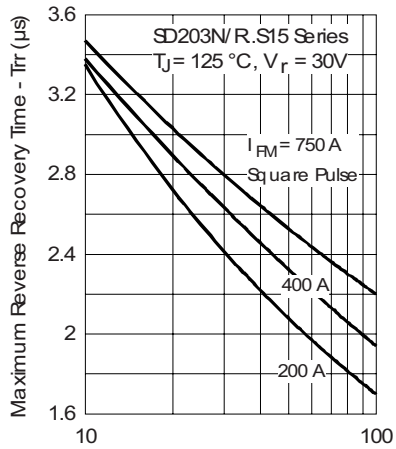

Rate Of Fall Of Forward Current -  $di/dt$  (A/ $\mu$ s)  
Fig. 13 - Recovery Time Characteristics

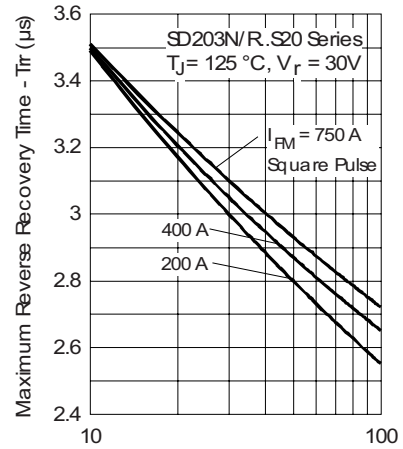

Rate Of Fall Of Forward Current -  $di/dt$  (A/ $\mu$ s)  
Fig. 16 - Recovery Time Characteristics

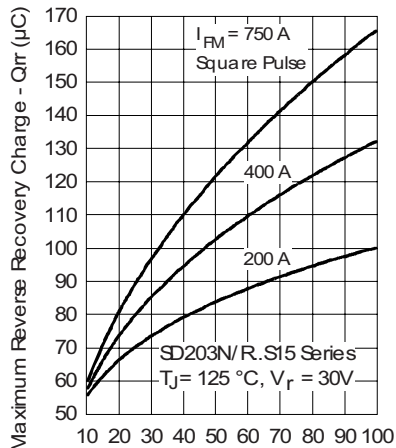

Rate Of Fall Of Forward Current -  $di/dt$  (A/ $\mu$ s)  
Fig. 14 - Recovery Charge Characteristics

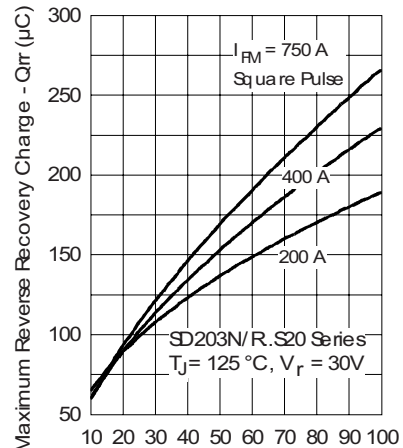

Rate Of Fall Of Forward Current -  $di/dt$  (A/ $\mu$ s)  
Fig. 17 - Recovery Charge Characteristics

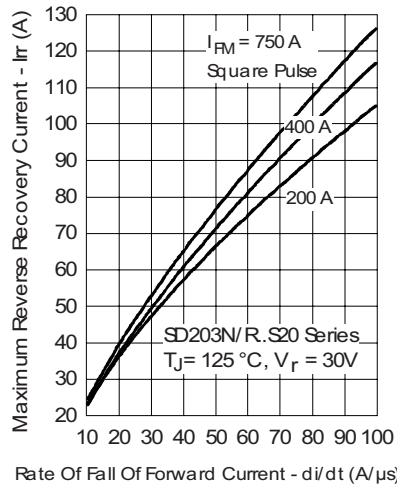

Fig. 18 - Recovery Current Characteristics

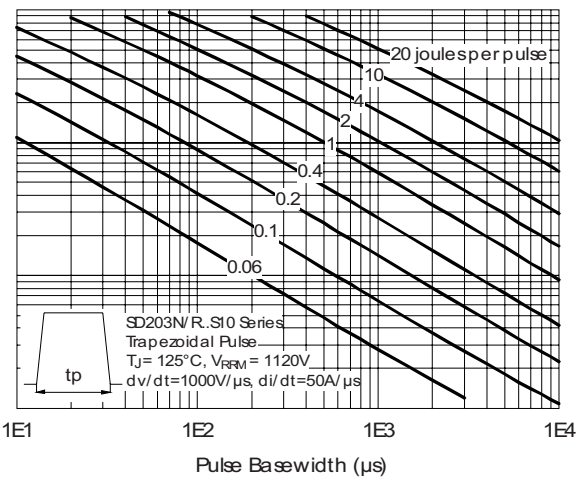
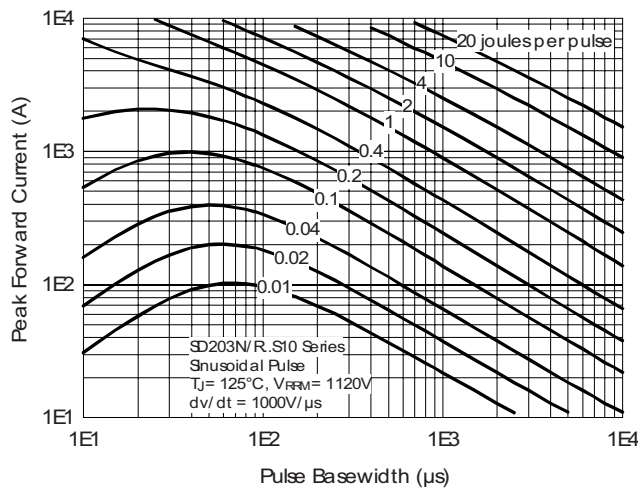

Fig. 19 - Maximum Total Energy Loss Per Pulse Characteristics

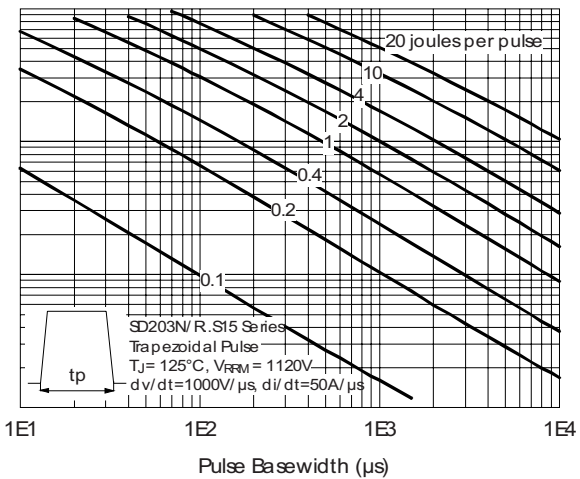
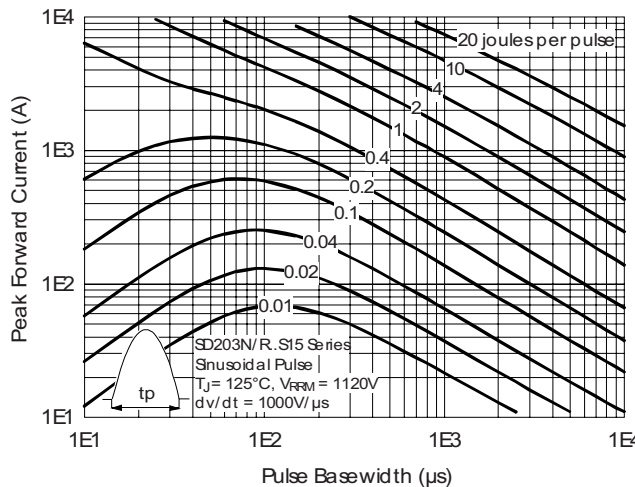

Fig. 20 - Maximum Total Energy Loss Per Pulse Characteristics

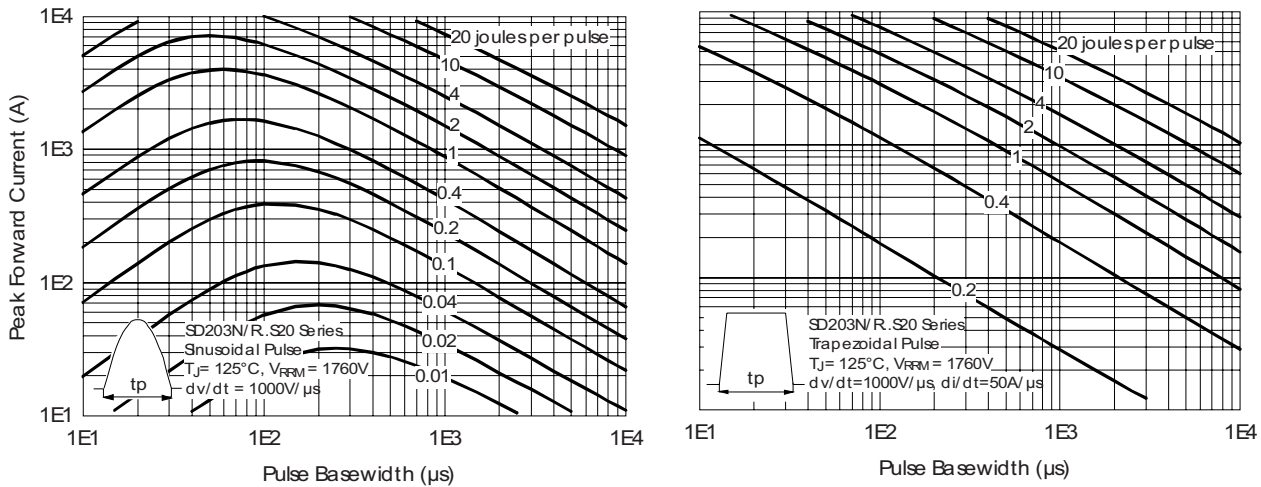

Fig. 21 - Maximum Total Energy Loss Per Pulse Characteristics

## ORDERING INFORMATION TABLE

Device code	<b>SD</b>	<b>20</b>	<b>3</b>	<b>R</b>	<b>25</b>	<b>S20</b>	<b>P</b>	<b>B</b>	<b>C</b>
	①	②	③	④	⑤	⑥	⑦	⑧	⑨

- 1** - Diode
- 2** - Essential part number
- 3** - 3 = Fast recovery
- 4** - • N = Stud normal polarity (cathode to stud)  
• R = Stud reverse polarity (anode to stud)
- 5** - Voltage code x 100 =  $V_{RRM}$  (see Voltage Ratings table)
- 6** -  $t_{rr}$  code (see Recovery Characteristics table)
- 7** - • P = Stud base DO-205AB (DO-9) 3/4" 16UNF-2A  
• M = Stud base DO-205AB (DO-9) M16 x 1.5
- 8** - • B = Flag top terminals (for cathode/ anode leads)  
• S = Isolated lead with silicon sleeve  
(red = Reverse polarity; blue = Normal polarity)  
• None = Not isolated lead
- 9** - • C = Ceramic housing (over 1600 V)  
• V = Glass-metal seal (only up to 1600 V)

LINKS TO RELATED DOCUMENTS	
Dimensions	<a href="http://www.vishay.com/doc?95301">http://www.vishay.com/doc?95301</a>



## DO-205AB (DO-9)

**DIMENSIONS** in millimeters (inches)

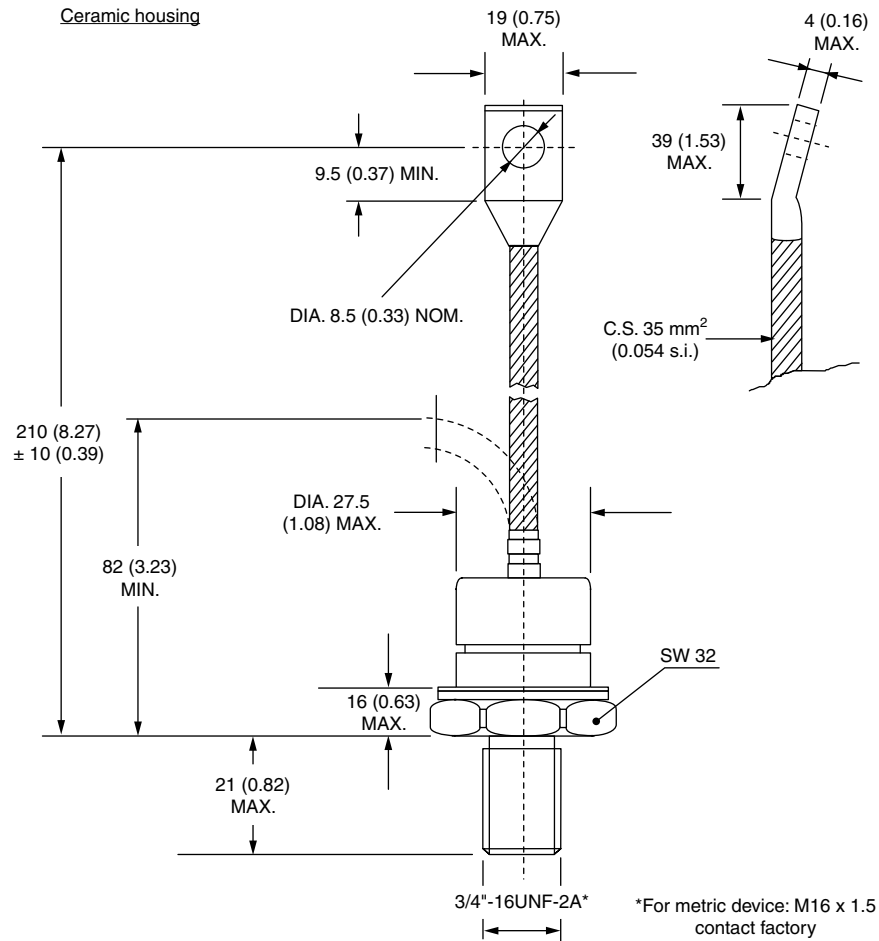



## Disclaimer

ALL PRODUCT, PRODUCT SPECIFICATIONS AND DATA ARE SUBJECT TO CHANGE WITHOUT NOTICE TO IMPROVE RELIABILITY, FUNCTION OR DESIGN OR OTHERWISE.

Vishay Intertechnology, Inc., its affiliates, agents, and employees, and all persons acting on its or their behalf (collectively, "Vishay"), disclaim any and all liability for any errors, inaccuracies or incompleteness contained in any datasheet or in any other disclosure relating to any product.

Vishay makes no warranty, representation or guarantee regarding the suitability of the products for any particular purpose or the continuing production of any product. To the maximum extent permitted by applicable law, Vishay disclaims (i) any and all liability arising out of the application or use of any product, (ii) any and all liability, including without limitation special, consequential or incidental damages, and (iii) any and all implied warranties, including warranties of fitness for particular purpose, non-infringement and merchantability.

Statements regarding the suitability of products for certain types of applications are based on Vishay's knowledge of typical requirements that are often placed on Vishay products in generic applications. Such statements are not binding statements about the suitability of products for a particular application. It is the customer's responsibility to validate that a particular product with the properties described in the product specification is suitable for use in a particular application. Parameters provided in datasheets and/or specifications may vary in different applications and performance may vary over time. All operating parameters, including typical parameters, must be validated for each customer application by the customer's technical experts. Product specifications do not expand or otherwise modify Vishay's terms and conditions of purchase, including but not limited to the warranty expressed therein.

Except as expressly indicated in writing, Vishay products are not designed for use in medical, life-saving, or life-sustaining applications or for any other application in which the failure of the Vishay product could result in personal injury or death. Customers using or selling Vishay products not expressly indicated for use in such applications do so at their own risk and agree to fully indemnify and hold Vishay and its distributors harmless from and against any and all claims, liabilities, expenses and damages arising or resulting in connection with such use or sale, including attorneys fees, even if such claim alleges that Vishay or its distributor was negligent regarding the design or manufacture of the part. Please contact authorized Vishay personnel to obtain written terms and conditions regarding products designed for such applications.

No license, express or implied, by estoppel or otherwise, to any intellectual property rights is granted by this document or by any conduct of Vishay. Product names and markings noted herein may be trademarks of their respective owners.

## Material Category Policy

**Vishay Intertechnology, Inc. hereby certifies that all its products that are identified as RoHS-Compliant fulfill the definitions and restrictions defined under Directive 2011/65/EU of The European Parliament and of the Council of June 8, 2011 on the restriction of the use of certain hazardous substances in electrical and electronic equipment (EEE) - recast, unless otherwise specified as non-compliant.**

**Please note that some Vishay documentation may still make reference to RoHS Directive 2002/95/EC. We confirm that all the products identified as being compliant to Directive 2002/95/EC conform to Directive 2011/65/EU.**