

### Features

- Schottky Barrier Chip
- Guard Ring Die Construction for Transient Protection
- High Current Capability
- Low Power Loss, High Efficiency
- High Surge Current Capability
- For Use in Low Voltage, High Frequency Inverters, Free Wheeling, and Polarity Protection Applications

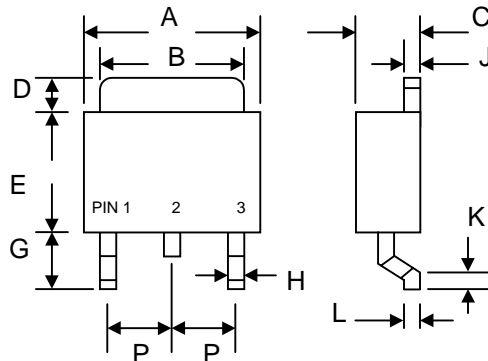

### Mechanical Data

- Case: Molded Plastic
- Terminals: Plated Leads Solderable per MIL-STD-750, Method 2026
- Polarity: Cathode Band
- Weight: 0.4 grams (approx.)
- Mounting Position: Any
- Marking: Type Number
- Standard Packaging: 16mm Tape (EIA-481)

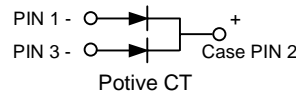

D PAK/TO-252AA		
Dim	Min	Max
A	6.4	6.8
B	5.0	5.4
C	2.35	2.75
D	—	1.60
E	5.3	5.7
G	2.3	2.7
H	0.4	0.8
J	0.4	0.6
K	0.3	0.7
L	0.50 Typical	
P	—	2.3
All Dimensions in mm		

### Maximum Ratings and Electrical Characteristics @T<sub>A</sub>=25°C unless otherwise specified

Single Phase, half wave, 60Hz, resistive or inductive load. For capacitive load, derate current by 20%.

Characteristic	Symbol	SD 820CS	SD 830CS	SD 840CS	SD 850CS	SD 860CS	SD 880CS	SD 8100CS	Unit
Peak Repetitive Reverse Voltage	V <sub>RRM</sub>	20	30	40	50	60	80	100	V
Working Peak Reverse Voltage	V <sub>RWM</sub>								
DC Blocking Voltage	V <sub>R</sub>								
RMS Reverse Voltage	V <sub>R(RMS)</sub>	14	21	28	35	42	56	70	V
Average Rectified Output Current @T <sub>L</sub> = 85°C	I <sub>O</sub>	8.0							A
Non-Repetitive Peak Forward Surge Current 8.3ms Single half sine-wave superimposed on rated load (JEDEC Method)	I <sub>FSM</sub>	85							A
Forward Voltage (Note 1) @I <sub>F</sub> = 4.0A	V <sub>FM</sub>	0.65		0.75		0.85		V	
Peak Reverse Current @T <sub>A</sub> = 25°C At Rated DC Blocking Voltage @T <sub>A</sub> = 100°C	I <sub>RM</sub>	0.2 20							mA
Typical Junction Capacitance (Note 2)	C <sub>j</sub>	400							pF
Typical Thermal Resistance Junction to Ambient	R <sub>θJA</sub>	60							K/W
Operating Temperature Range	T <sub>j</sub>	-50 to +125							°C
Storage Temperature Range	T <sub>STG</sub>	-50 to +150							°C

Note: 1. Mounted on P.C. Board with 14mm<sup>2</sup> (0.13mm thick) copper pad.  
2. Measured at 1.0 MHz and applied reverse voltage of 4.0V D.C.

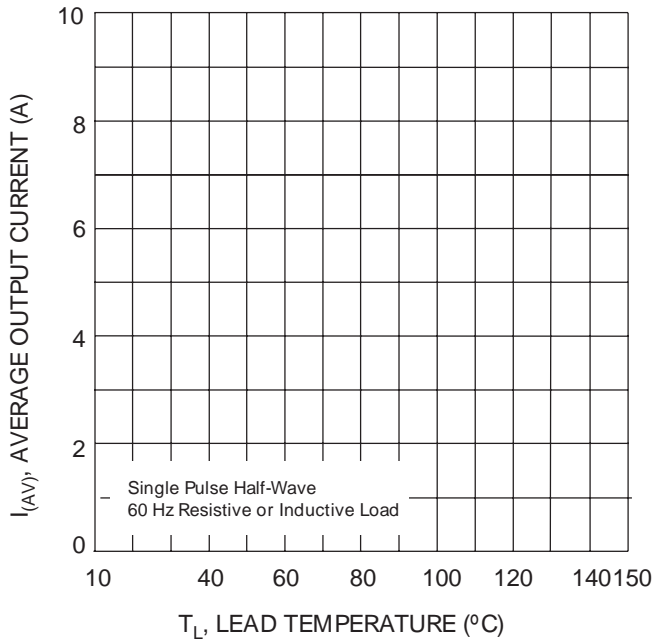

Fig. 1 Forward Current Derating Curve

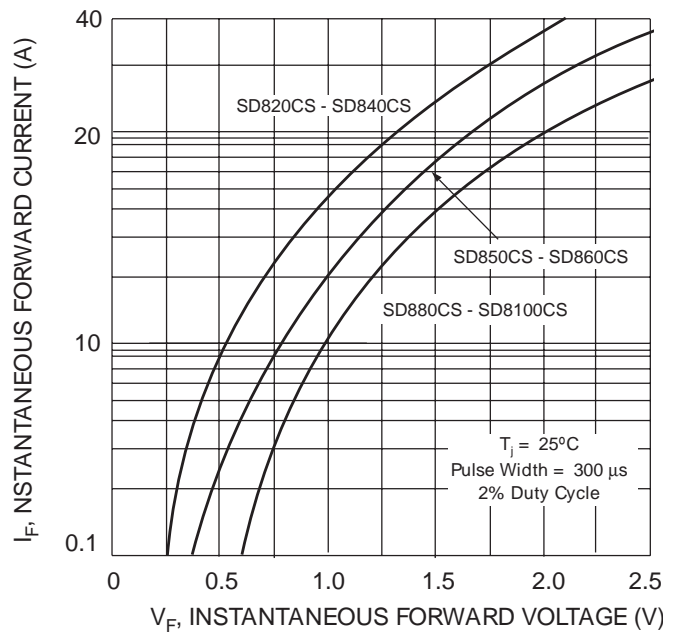

Fig. 2 Typical Forward Characteristics

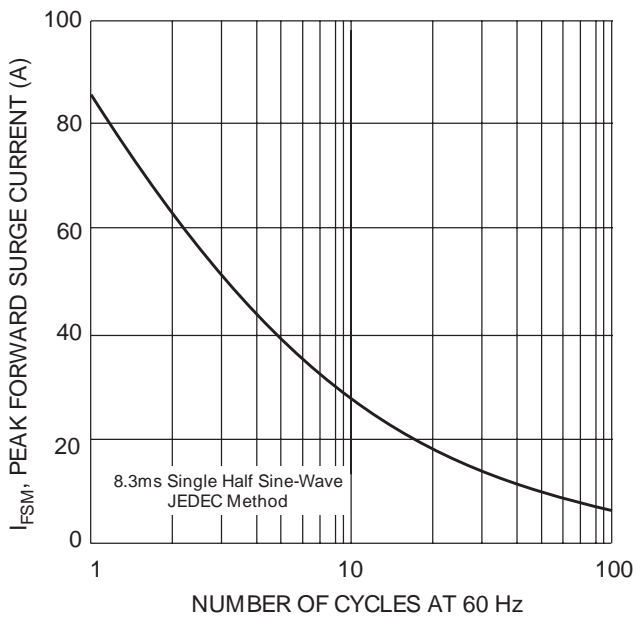

Fig. 3 Maximum Non-Repetitive Peak Fwd Surge Current

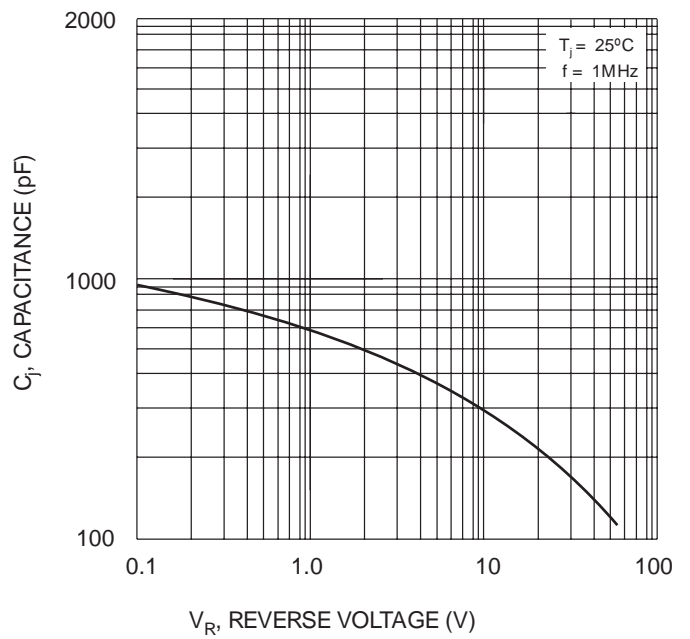

Fig. 4 Typical Junction Capacitance

## ORDERING INFORMATION

Product No.◆	Package Type	Shipping Quantity
SD820CS-T3	DPAK	2500/Tape & Reel
SD830CS-T3	DPAK	2500/Tape & Reel
SD840CS-T3	DPAK	2500/Tape & Reel
SD850CS-T3	DPAK	2500/Tape & Reel
SD860CS-T3	DPAK	2500/Tape & Reel
SD880CS-T3	DPAK	2500/Tape & Reel
SD8100CS-T3	DPAK	2500/Tape & Reel

◆T3 suffix refers to a 13" reel.

Shipping quantity given is for minimum packing quantity only. For minimum order quantity, please consult the Sales Department.

## RECOMMENDED FOOTPRINT

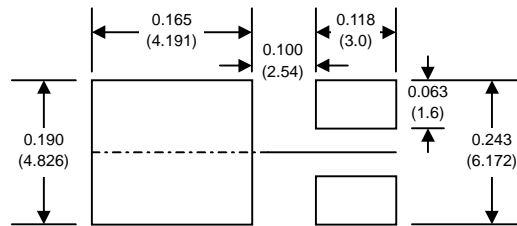

inches(mm)

Won-Top Electronics Co., Ltd (WTE) has checked all information carefully and believes it to be correct and accurate. However, WTE cannot assume any responsibility for inaccuracies. Furthermore, this information does not give the purchaser of semiconductor devices any license under patent rights to manufacturer. WTE reserves the right to change any or all information herein without further notice.

**WARNING:** DO NOT USE IN LIFE SUPPORT EQUIPMENT. WTE power semiconductor products are not authorized for use as critical components in life support devices or systems without the express written approval.

**Won-Top Electronics Co., Ltd.**

No. 44 Yu Kang North 3rd Road, Chine Chen Dist., Kaohsiung, Taiwan

**Phone:** 886-7-822-5408 or 886-7-822-5410

**Fax:** 886-7-822-5417

**Email:** sales@wontop.com

**Internet:** <http://www.wontop.com>

*We power your everyday.*