

PRELIMINARY DATA SHEET

**SDA 9380-B21**  
**EDDC**  
**Enhanced Deflection**  
**Controller and**  
**RGB Processor**

## Document Change Note

DS <sup>1</sup>	Date	Page	Changes compared to previous issue
2	31.03.98		Version 02
<b>3</b>	<b>17.07.98</b>		<b>Document state 03 corresponds to silicon version A11</b>
	23.07.98	3	block diagram changed
	23.07.98	46	bandwidth of YUV increased (new value 30 MHz)
	27.07.98	27	Vertical component of SCP changed (not equals internal signal VBL!)
	07.08.98	4, 5, 6	Pin configuration changed
	09.09.98	14, 17, 20	Description of PMW byte changed
	14.09.98	43	SCP output level changed (supply voltage for SCP is $V_{DD(MC)}$ )
	16.09.98	14,15	Sequence of I <sup>2</sup> C control items changed, new items added
	16.09.98	24	Bit SLBLKS added to RGB control byte 1
	16.09.98	20	Detailed description of the I <sup>2</sup> C item PWM control byte
	16.09.98	25, 26	Detailed description of the items Average beam current limit characteristics, Peak drive limit, Soft clipping
	16.09.98	34	Explanation of the items Peak dark detection top border, bottom border, left border, right border
	18.09.98	21	I <sup>2</sup> C bit KILLZIP deleted, KILLZIP function remains implemented
	18.09.98	10, 21, 39	I <sup>2</sup> C bit HSWID deleted
	18.09.98	10, 21, 39	I <sup>2</sup> C bit HSWMI added
	18.09.98	10, 39	Positive and negative polarity of HSYNC allowed (int. normalization)
	20.10.98	1, 3, 10, 39	18.75 kHz line frequency added
	27.10.98	14, 31, 32	End of V-blanking also programmable by VBE if JMP=0
	12.11.98	31	Specification of end of V-blanking component of SCP changed
	19.11.98	21	3 MSBs of PLL control byte 1 must be 0 instead of don't care
	24.11.98	4	Pin configuration changed
	02.12.98	40	HSAFE input voltage at 31.25 kHz and 38 kHz specified
	04.12.98	40	VREFP, VREFH, VREFL are internal reference voltages
	04.12.98	39	Input BSOIN, delay $t_{D2}$ changed from 30 lines to 42 lines
	04.12.98	15	Default value of saturation control changed form 0 to -12
	18.01.99	19	I <sup>2</sup> C bus bits NR, NL2...NL0 of Vertical sync byte control deleted
	21.01.99	1, 7, 11	Text changed because the vertical noise reduction has been removed
	21.01.99	11	Remark for switching to external clock mode added
	22.01.99	5, 6	Pin description changed
	05.02.99	7, 8	Description of Black Switch Off (BSO) changed
	26.02.99	37	VSS, SUBST total voltage differentials added
	15.03.99	2, 14, 46	Higher resolution of D/A output (6 bit -> 8 bit), INL changed (1 -> 2 LSB)
	15.03.99	15, 43	Contrast setting with resolution of 8 bit instead of 6 bit
	15.03.99	15, 44	Brightness setting with resolution of 8 bit instead of 6 bit
	16.03.99	43	NTSC/US matrix changed

DS <sup>1</sup>	Date	Page	Changes compared to previous issue
	24.03.99	46	DAC output D/A: DNL changed from +-0.5 LSB to +-1 LSB
	29.03.99	22	IIC bus: ABLTCS1, 0 added
	29.03.99	25	IIC bus: GAIN2 added, MODE changed
	30.03.99	26	IIC bus: Peak drive limit, bit 3 added (hidden bit for Black stretch)
	07.04.99	38	Input BSOIN: hysteresis added
	12.04.99	22, 25, 15	IIC bus: ABLTCS1, 0 deleted, MODE default field frequent, Tdown independent of MODE, default value for IIC reg. 27h set to -64
	13.04.99	12	18.75kHz only possible with internal clock generation
	19.04.99	45, 46	I <sup>2</sup> C bus specification completed
	19.04.99	48	Hysteresis of H35K, H38K adjusted
	19.04.99	19	PWMC data corrected in case of PWM output is used as switch output
	20.04.99	53	Power-on reset thresholds added
	20.04.99	17, 28, 29, 39	default range of input IBEAM changed
	20.04.99	17, 42	I <sup>2</sup> C bit RDCl added for switching of DCI input range
	28.04.99	24, 50	Delay from SVM to RGB outputs reduced
	28.04.99	49	Min. Bandwidth of RGB outputs specified
	29.04.99	39	Pins for reference voltages VREFP, VREFL deleted
	29.04.99	3,4,5,27,46	New output pin PROTON added
	29.04.99	3,4,6,30,46	New output pin VBLO added
	11.05.99	51, 52	Application information added
	21.05.99	15, 43	Nominal saturation changed to -11
	31.05.99	9	Delay of BG-pulse to HSYNC in internal clock mode changed
	08.06.99	24, 40, 41	Differential input for RGB/YUV 1 removed
	10.06.99	30	V-blanking component of SCP corresponds with internal blanking VBL
	24.06.99	1, 2	RGB 1 input changed to RGB/YUV1, COR feature added
	24.06.99	5	Test pins changed
	24.06.99	12, 54, 55	Reset modes of IIC-Registers changed, POR delay changed to 32768
	24.06.99	6,12,38,39, 42, 46, 47, 48, 54, 55	VREFP and VREFL removed, VREFH and VREFC changed
	24.06.99	40, 51, 52	External capacitances of the quartz oscillator changed to 15pF
	24.06.99	40, 41	YUV and RGB inputs bias voltages added
	24.06.99	43	Nominal value of saturation changed
	24.06.99	46, 47	DAC outputs (E/W, D/A, VD+, VD-) changed
	24.06.99	50	SVM output: black level added
	24.06.99	54	POR levels changed
	28.06.99	12, 58	Text RGB processing, diagrams black stretch and soft clipping added
	29.06.99	8	Second paragraph changed (protection circuit)
	30.06.99	29	Equations of Vertical EHT compensation changed

DS <sup>1</sup>	Date	Page	Changes compared to previous issue
	30.06.99	30	Equations of Horizontal and AFC EHT compensation changed
	09.07.99	38, 39	Minimum ambient temperature at operating changed from -20 to 0 °C
	09.07.99	21	Bit position 6 of PLL control byte 0 must be set to 0
	19.07.99	55	diagrams of BSO modes added
	16.08.99	20	PWM control: amplitude of V-parabola reduced
<b>4</b>	<b>29.09.99</b>		<b>Document state 04 corresponds to silicon version B11</b>
	29.09.99	41	YUV input levels for HDTV added
	29.09.99	23, 41	Low level Y0 input added
	26.10.99	46	High level input voltage of I <sup>2</sup> C bus changed to 0.75*V <sub>DD(D)</sub>
	15.11.99	42	Second value of V <sub>clampY</sub> in case of differential input deleted
	18.11.99	7, 38, 49, 52, 53	HD output changed to open drain
	19.11.99	50	Tolerances for black levels added (offset regulation)
	19.11.99	39	Tolerances for supply voltages decreased
	22.11.99	16, 26, 27	IIC bit YLL moved to reg. 22h, SW and RDCI moved to reg. 29h
	22.11.99	23	IIC bits IN1NOM and IN2NOM added
	06.12.99	1, 13, 15, 16, 55, 56	Control item Extreme corner pin correction at subaddress 0Eh added, item D/A moved to subaddress 30h
	06.12.99	47	Input leakage current of all inputs specified
	13.12.99	26	ABL: Time constants changed
	17.12.99	26	ABL: Up time constants changed
	21.01.00	4, 5, 52	Pin X1 and X2 exchanged
	26.01.00	47	SCP output High level and blanking level changed
	11.02.00	7	Last paragraph regarding soft start adapted
	11.02.00	22	Warning 4 of previous edition deleted, warning 5 changed (now no. 4)
	11.02.00	39	Any rise time of the supply voltages is allowed
	10.03.00	49	Minimum value of maximum RGB output voltage changed
	29.03.00	20	PWM control byte: specification of V-parabola amplitude changed
<b>5</b>	<b>29.05.00</b>		<b>Document state 05 corresponds to silicon version B12</b>
	29.05.00	3	block delay moved between the blocks brightness and blue stretch
	29.05.00	43	Min./Max. values of matrices removed
	29.05.00	44	Min./Max. values of black level stretch changed
	29.05.00	47	Output LOW and output HIGH value of D/A changed
	29.05.00	1, 7, 13, 21	Specified H-frequency range of 15 to 19kHz added
	05.07.00	52	Circuit at DCI input changed
	05.07.00	34	Explanation of average beam current limit added
<b>6</b>	<b>25.08.00</b>		<b>Document state 06 corresponds to silicon version B21</b>
	18.08.00	39	Positive-going of BSOIN upper threshold increased by 50mV
	25.08.00	44	Brightness control range changed, nom. brightness removed

DS <sup>1</sup>	Date	Page	Changes compared to previous issue
	25.08.00	49	Nominal brightness and measurement levels changed
	28.08.00	44	Black stretch level shift changed
	28.08.00	50	Foot note 1) added
	04.10.00	38	Absolute maximum rating of VDD(MC) = 9V
	04.10.00	38	Absolute maximum rating of total power dissipation = 1.28W
	04.10.00	46	Supply currents and total power dissipation specified
	04.10.00	47	DAC output D/A: LOW and HIGH value changed
	04.10.00	47	DAC output E/W: LOW and HIGH value changed
	04.10.00	48	DAC output VD+, VD-: LOW and HIGH value changed
	04.10.00	50	SVM output signal amplitude changed from 2V to 1.9V nom.
	10.10.00	51	System overview Dig. TV 100 Hz changed
	16.10.00	38...40	Pin schematic inserted
	23.10.00	36	Equations for cut-off and white-drive currents added
	25.10.00	29	Equations for Vertical EHT compensation modified
	25.10.00	30	Equations for Horizontal EHT compensation modified
	22.11.00	45	Max. input capacitance of YUV and RGB inputs specified
	22.11.00	50	Standby current specified
	22.11.00	50	Total power dissipation changed from max. 1.25W to max. 1.28W
	29.01.01	all	Infineon logo changed to Micronas

1)... DS = Document state

**Data Classification****Maximum Ratings**

Maximum ratings are absolute ratings; exceeding only one of these values may cause irreversible damage to the integrated circuit.

**Recommended Operating Conditions**

Under this conditions the functions given in the circuit description are fulfilled. Nominal conditions specify mean values expected over the production spread and are the proposed values for interface and application. If not stated otherwise, nominal values will apply at  $T_A=25^{\circ}\text{C}$  and the nominal supply voltage

**Characteristics**

The listed characteristics are ensured over the operating range of the integrated circuit.

## Contents

<b>1</b>	<b>General description</b>	<b>1</b>
<b>2</b>	<b>Features</b>	<b>1</b>
2.1	Deflection	1
2.2	RGB Video	2
<b>3</b>	<b>Block diagram.</b>	<b>3</b>
<b>4</b>	<b>Pin configuration</b>	<b>4</b>
4.1	Pin description	5
<b>5</b>	<b>System description</b>	<b>7</b>
5.1	Functional description.	7
5.1.1	Deflection controller	7
5.1.2	RGB processing	10
5.2	Circuit description	11
5.3	Reset modes.	13
5.4	Frequency ranges.	13
5.5	I <sup>2</sup> C-Bus control	14
5.5.1	I <sup>2</sup> C-Bus address	14
5.5.2	I <sup>2</sup> C-Bus format	14
5.5.3	I <sup>2</sup> C-Bus commands	15
5.5.4	Detailed description	18
5.5.5	Explanation of some control items	29
<b>6</b>	<b>Pin schematic</b>	<b>39</b>
<b>7</b>	<b>Absolute maximum ratings</b>	<b>42</b>
<b>8</b>	<b>Recommended operating conditions</b>	<b>43</b>
<b>9</b>	<b>Characteristics (assuming recommended operating conditions)</b>	<b>50</b>
<b>10</b>	<b>Application information</b>	<b>55</b>
10.1	System overview Dig. TV 100Hz	55
10.2	System overview multisync deflection	55
10.3	Application circuit diagram	56
<b>11</b>	<b>Waveforms</b>	<b>57</b>
11.1	Timing diagram of H35K and H38K	57
11.2	Black Switch-Off diagram	57
11.3	Power On/Off diagram	59
11.4	Standby mode, RESN diagram.	60
11.5	Function of H,V protection	61

11.6 Black Stretch diagram. . . . . 62

11.7 Soft Clipping diagram . . . . . 62

**12 Package outlines . . . . . 63**



## General description

## 1 General description

The SDA 9380 is a highly integrated deflection controller and RGB video processor for CTV receivers with 15 to 19kHz or 31 to 38kHz line frequencies. The deflection component controls among others an horizontal drive 2001-01-29r circuit for a flyback line output stage, a DC coupled vertical sawtooth output stage and an East-West raster correction circuit. All adjustable output parameters are I<sup>2</sup>C-Bus controlled. Inputs are HSYNC and VSYNC. The HSYNC signal is the reference for the internal clock system which includes the  $\Phi 1$  and  $\Phi 2$  control loops.

The RGB processor has two YUV/RGB inputs and one RGB input. One YUV/RGB input and the RGB input are for SVGA and text/OSD with fast blanking. The RGB output stage has two control loops for cut off and white level with halt capability in vertical shrink modes. An overall Y output and an adjustable delay of the RGB outputs related to this signal are suitable for a scan velocity modulation circuit.

The supply voltages of the IC are 3.3V and 8V. It is mounted in a P-MQFP package with 64 pins.

## 2 Features

### 2.1 Deflection

- No external clock needed
- $\Phi 1$  PLL and  $\Phi 2$  PLL on chip
- Standard line frequencies for NTSC and PAL
- 18.75kHz line frequency for 625 lines/60 Hz
- Doubled line frequencies for NTSC and PAL, MUSE standard, DTV standard
- Also suitable for VGA, Macintosh (35kHz) and SVGA standard (38kHz, 800\*600\*60Hz)
- Automatic switching between 31, 35 and 38kHz in Monitor mode with 2 digital outputs for controlling B+ and 1 analog input to keep watch on it
- I<sup>2</sup>C-Bus alignment of all deflection parameters
- All EW-, V- and H- functions
- Picture width and picture height EHT compensation
- Dynamic PH EHT compensation (white bar)
- Compensation of H-phase deviation (e.g. caused by white bar)
- Upper/lower EW-corner correction separately adjustable
- Extreme EW-corner correction (coefficient of sixth order) for super flat tubes
- V-angle and V-bow correction
- Two special control items for vertical zoom/shrink and scroll function with absolutely correct tracking of the E/W and HD-output signals
- No re-adjustment of E/W after changing vertical S-correction and linearity needed
- H-frequent PWM output signal for generating an adjustable vertical frequent parabola or a constant pulse width, selectable by I<sup>2</sup>C
- H- and V-blanking time adjustable
- Partial overscan adjustable to hide the cut off control measuring lines in the reduced scan modes
- Self adaptation of V-frequency / number of lines per field between 192 and 680 for each possible line frequency
- Selectable Black Switch-Off behaviour via I<sup>2</sup>C-Bus

## Features

- Protection against EHT run away (X-rays protection)
- Protection against missing V-deflection (CRT-protection)
- D/A output with 8 bit resolution for general purpose
- Digital output for general purpose, controlled by I<sup>2</sup>C-Bus
- Selectable softstart of the H-output stage

## 2.2 RGB Video

- Two universal YUV/RGB inputs and one RGB input, one YUV/RGB and RGB input with fast blanking capability
- One fast blank input with contrast reduction capability
- Switchable color difference matrix for PAL/SECAM, NTSC(U.S.), NTSC(Japan) and HDTV
- Common saturation, brightness and contrast control for all three input channels possible
- Cut off and white level control loop
- Halt command for white level control loop to switch off the white level reference lines in vertical shrink mode
- Black stretching of non-standard input signals
- Selectable blue stretch circuit shifting white towards light blue
- Peak drive limiter with soft clipping, adjustable per I<sup>2</sup>C
- Average beam current limiter, adjustable per I<sup>2</sup>C
- Luminance output signal SVM for scan velocity modulation; adjustable delay from SVM to the RGB outputs

3 Block diagram

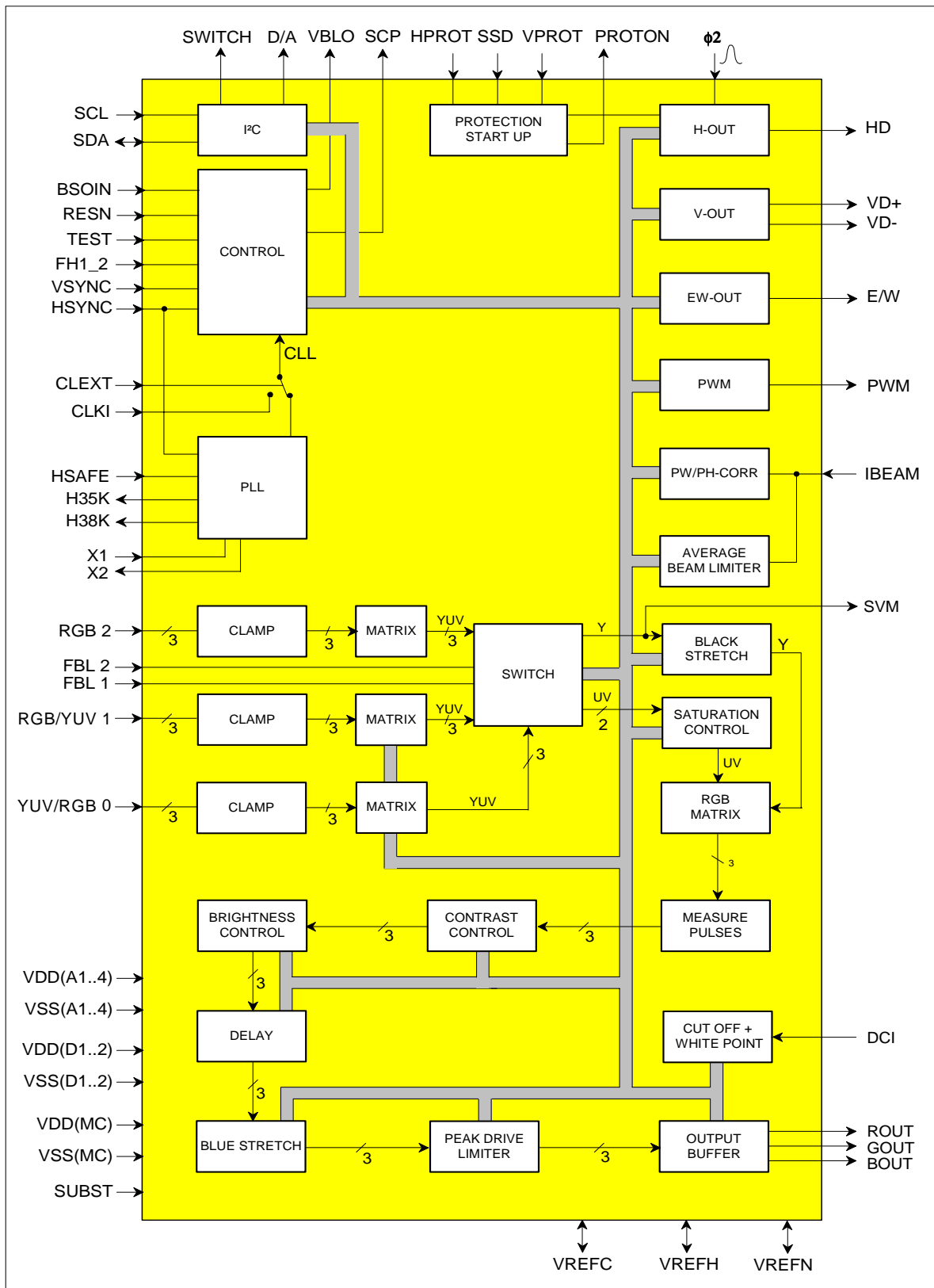

### 4 Pin configuration

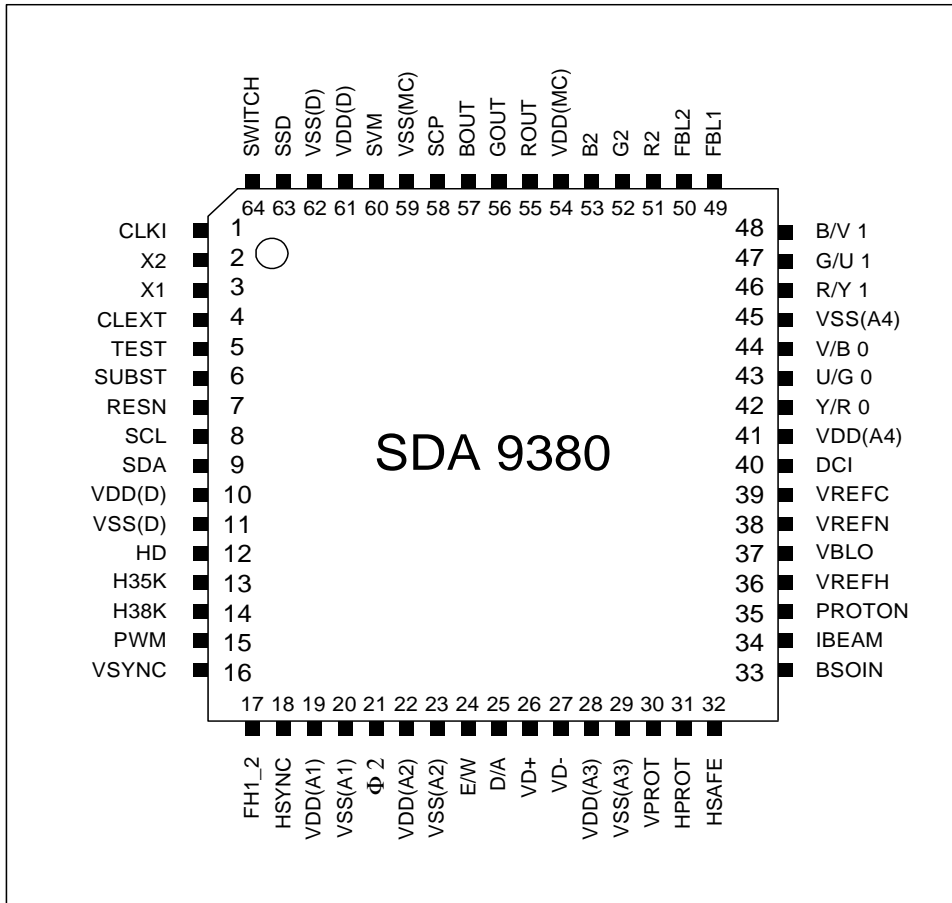

## Pin configuration

## 4.1 Pin description

Pin No.	Name	Type	Description
1	CLKI	I/TTL	Input for external line locked clock *)
2	X2	Q	Reference oscillator output, Crystal
3	X1	I	Reference oscillator input, Crystal
4	CLEXT	I/TTL	Switching between internal (L) and external clock (H) *)
5	TEST	I/TTL	Switching between normal operation (TEST=L) and test mode (TEST=H: pins 4, 12, 13, 14, 15, 17, 49, 50, 63, 64 are additional test pins)
6	SUBST	S	Substrate pin, has to be connected to ground whenever a power supply or signal is applied
7	RESN	I/TTL	Reset input, active Low
8	SCL	I	I <sup>2</sup> C Bus clock
9	SDA	IQ	I <sup>2</sup> C Bus data
10	VDD(D)	S	Digital supply
11	VSS(D)	S	Digital ground
12	HD	Q	Control signal output for H driver stage (open drain)
13	H35K	Q/TTL	Goes High when frequency of HSYNC is about 35kHz or more
14	H38K	Q/TTL	Goes High when frequency of HSYNC is about 38kHz
15	PWM	Q/TTL	Pulse width modulated control signal output
16	VSYNC	I/TTL	V-sync input
17	FH1_2	I/TTL	Switching between 1f <sub>H</sub> mode (L) and 2f <sub>H</sub> mode (H)
18	HSYNC	I	HSYNC input (CLEXT=H: TTL; CLEXT=L: analog) *)
19	VDD(A1)	S	Analog supply
20	VSS(A1)	S	Analog ground
21	Φ2	I	Line flyback for H-delay compensation
22	VDD(A2)	S	Analog supply
23	VSS(A2)	S	Analog ground
24	E/W	Q	Control signal output for East-West raster correction
25	D/A	Q	Output of an I <sup>2</sup> C Bus controlled DC voltage
26	VD+	Q	Control signal output for DC coupled V-output stage
27	VD-	Q	Like VD+
28	VDD(A3)	S	Analog supply
29	VSS(A3)	S	Analog ground
30	VPROT	I	Watching external V-output stage (input is the V-saw-tooth from feedback resistor)
31	HPROT	I	Watching EHT (input is e.g. H-flyback)
32	HSAFE	I	Watching B+ when frequency of HD has to be decreased
33	BSOIN	I	Input for starting Black Switch-Off
34	IBEAM	I	Input for a beam current dependent signal for stabilization of width, height and H-phase
35	PROTON	Q/TTL	Protection on (goes High after response of H- or V-protection)

## Pin configuration

Pin No.	Name	Type	Description
36	VREFH	IQ	Reference voltage
37	VBLO	Q/TTL	Vertical blanking output
38	VREFN	IQ	Ground for VREFH
39	VREFC	I	Reference current input
40	DCI	I	Dark current input for cut off and white level control
41	VDD(A4)	S	Analog supply
42	Y/R 0	I	Luminance or R input
43	U/G 0	I	U signal or G input
44	V/B 0	I	V signal or B input
45	VSS(A4)	S	Analog ground
46	R/Y 1	I	First R or Y input for insertion
47	G/U 1	I	First G or U input for insertion
48	B/V 1	I	First B or V input for insertion
49	FBL1	I	Fast blanking input for RGB1
50	FBL2	I	Fast blanking input for RGB2
51	R2	I	Second R input for insertion
52	G2	I	Second G input for insertion
53	B2	I	Second B input for insertion
54	VDD(MC)	S	Analog supply for RGB output stage
55	ROUT	Q	R output
56	GOUT	Q	G output
57	BOUT	Q	B output
58	SCP	Q	Blanking signal with H- and color burst component (V-component selectable by I <sup>2</sup> C Bus)
59	VSS(MC)	S	Analog ground for RGB output stage
60	SVM	Q	Luminance output for scan velocity modulation circuit
61	VDD(D)	S	Digital supply
62	VSS(D)	S	Digital ground
63	SSD	I/TTL	Disables softstart
64	SWITCH	Q/TTL	Output of an I <sup>2</sup> C Bus controlled switch (register 00, bit SW)

\*) The external clock mode can not be used with 18.75, 33.75kHz, 35kHz and 38kHz line frequency.

## 5 System description

### 5.1 Functional description

#### 5.1.1 Deflection controller

The main input signals are HSYNC with a frequency range of about 31 to 38kHz and VSYNC with vertical frequencies of 50 to 120 Hz. When connecting pin FH1\_2 with Low level a line frequency of 15 to 19kHz is suitable.

For displaying computer signals horizontal frequencies up to 38 kHz can be processed.

In the selectable Monitor mode the adaptation to the input frequency in the range of 31.25 to 38kHz is done automatically. Two output pins (H35K and H38K) for controlling e.g. the supply voltage of the line output stage indicate the frequency of HSYNC. When the H-frequency is increasing, these outputs are stable until the frequency of HSYNC appears on the output HD (see 11.1). In case of decreasing H-frequency they are changed immediately to flag the new detected frequency but change of the PLL frequency will be not allowed until the supply voltage of the H-output stage (B+) is decreased. Pin HSAFE is used to watch B+.

The output signals control the horizontal as well as the vertical deflection stages and the East-West raster correction circuit.

The H-output signal HD (open drain output) compensates the delays of the line output stage and its phase can be modulated vertical frequent to remove horizontal distortions of vertical raster lines (V-Bow, V-Angle). Time reference is the middle of the front and back edge of the line flyback pulse. A positive HD pulse switches off the line output transistor. Maximal H-shift is about 2.25  $\mu$ sec for  $f_H=31$ kHz.

Picture tubes with 4:3 or 16:9 aspect ratio can be used by adapting the raster to the aspect ratio of the source signal.

The V-output saw-tooth signals VD- and VD+ controls a DC coupled output stage and can be disabled. Suitable blanking signals are delivered by the IC.

The East-West output signal E/W is a vertical frequent parabola of 6th order, enabling an extreme corner correction for super flat tubes. The common corner correction realised with coefficients of fourth order, is separately adjustable for the upper and lower part of the screen.

The pulse width modulated horizontal frequent output signal PWM has two options. A vertical frequent parabolic function or a constant pulse width in each line, selectable by I<sup>2</sup>C, is available. After external integration the parabola may be used for vertical dynamic focusing resp. the DC voltage for adjustment of H-offset or rotation.

The output D/A delivers a variable DC signal and an I<sup>2</sup>C Bus controlled digital output is available for general purpose.

The picture width and picture height compensation (PW/PH Comp) processes the beam current dependent input signal IBEAM with effect to the outputs E/W and VD to keep width and height constant and independent of brightness.

The alignment parameter AFC EHT Compensation enables to adjust the influence of the input signal IBEAM on the horizontal phase.

The selectable start up circuit controls the energy supply of the H-output stage during the receiver's run up time by smooth decreasing the line output transistors switching frequency down to the normal operating value (softstart). HD starts with about 1.7 times the line frequency and converges

## System description

within 85ms to its final value. The high time is kept constant. The normal operating pulse ratio H/L is either 45/55 or 40/60 (selectable by I<sup>2</sup>C). A watch dog function limits an increasing of the HD period to max. +10%.

The implemented Black Switch-Off behaviour is defined by two I<sup>2</sup>C bits (BSO1, BSO0). When enabled the signal at BSOIN (e.g. the supply voltage of the line output stage) is watched. If its level does not come up to a defined threshold Black Switch-Off is started (see 11.2). At first the RGB outputs are switched to continuous blanking immediately and the vertical output signals are changed to about 115..120% overscan. After a delay of 42 lines the picture tube capacitance is discharged with a current of some mA. From now the vertical overscan rate is calculated depending on the actual voltage at BSOIN to get the desired deflection angle. Three relations are selectable by I<sup>2</sup>C. After the voltage at BSOIN is dropped down to about 20% of its initial value the output HD and the overscan calculation may stop.

The protection circuit watches an EHT reference and the saw-tooth of the vertical output stage. If the EHT succeeds a defined threshold or if the V-deflection fails (refer to 11.5) the related bit is set in the status byte and the output PROTON goes High. The output HD is deactivated (H-level) immediately independent of the selected Black Switch-Off function.

HPROT:   input    $V_i < V_2$                    continuous blanking  
                    $V_i > V_1$                    HD disabled  
                    $V_2 \leq V_i < V_1$            operating range

VPROT:   vertical saw-tooth voltage  
            $V_i < V_1$  in first half of V-period  
           or  $V_i > V_2$  in second half : HD disabled

The pin SCP delivers the composite blanking signal SCP. It contains burst ( $V_b$ ), H-blanking HBL ( $V_{HBL}$ ) and selectable V-blanking (control bit SSC). The phase and width of the H-blanking period can be varied by I<sup>2</sup>C-Bus. For the timing following settings are possible :

BD = 1	: $T_{BL} = 0$
BD = 0, BSE = 0 (default value)	: $T_{HBL} = t_f$ (H-flyback time)
BD = 0, BSE = 1(alignment range)	: $T_{HBL} = (4 * H\_blanking\_time + 1) / CLL$
	: $T_{DBL} = (H\_shift + 4 * H\_blanking\_phase$ $- 2 * H\_blanking\_time + 45) / CLL$
SSC = 0	: $T_{BL} = T_{VBL}$ during V-blanking period
SSC = 1	: $T_{BL}$ is always $T_{HBL}$



System description

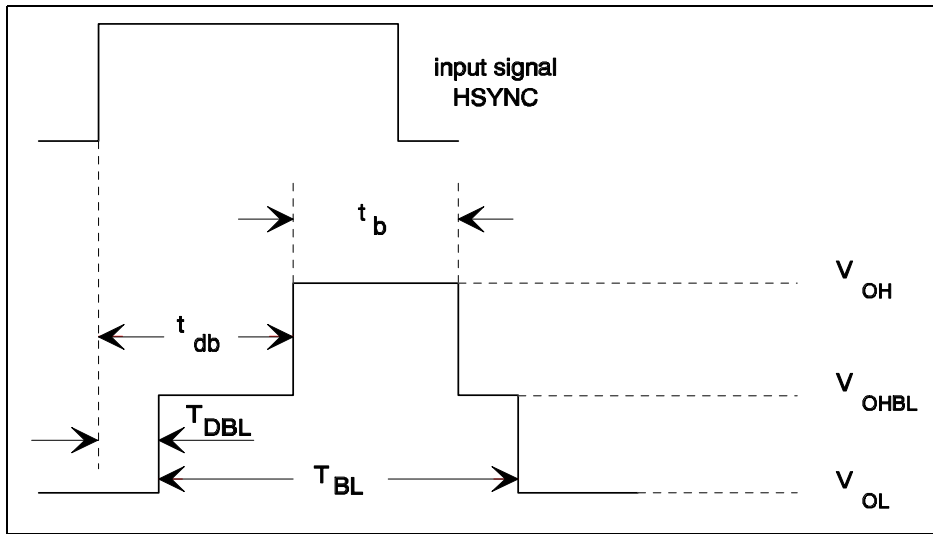

BG-pulse width t<sub>b</sub>  
 Delay to HSYNC t<sub>db</sub>

54 / CLL  
 internal clock: (78-4\*Internal\_H-sync\_phase) / CLL  
 external clock: (38-4\*Internal\_H-sync\_phase) / CLL

---

**System description****5.1.2 RGB processing**

To provide an accurate biasing of the picture tube the offsets and gains of the RGB output stages are continuously adjusted by a cut off and white level control loop. Leakage, cut off and white current are measured each frame during vertical flyback at the DCI input. The position of the measurement lines is adjustable by IIC bus (see page 31). The reference currents for the cut off and white levels are adjusted by IIC bus with a 6 bit parameter for each output and a common 3 bit gain parameter. Because the video amplifiers are part of the control loops, the overall gain and offset is no more adjustable in this stage. For proper dimensioning of the video amplifiers there is an IIC status bit (CLOW), which is 0 when all offset and gain actuators of the RGB outputs are within 50% of its full range. The control loops can be switched to halt mode to switch off the measurement lines in vertical shrink mode. When the TV screen is switched on brightness and contrast ramp up in a soft start mode as soon as the cut off control loop is locked.

There are three circuits implemented for beam current limiting:

-First there is a circuit for accurate average beam current limiting. The beam current is measured at the lbeam input and limited by reducing first contrast and, after half contrast is reached, brightness too. All parameters (limit value, gain, up time constant and down time constant) are adjustable by IIC bus.

-Second a peak drive limiter circuit is implemented for the higher frequency content of the video signal. It reduces contrast when a limit value is exceeded by the R, G or B video signals. Also all parameters (limit value, up time constant and down time constant) are adjustable by IIC bus.

-Third there is a soft clipper for the very high frequency content of the video signal. It limits the R, G or B video signals according to the diagram at 11.7. Limit value and slope are adjustable by IIC bus.

The TV screen can be switched to blue by IIC bus when no video signal is available.

When the blue stretch function is activated by IIC bus, the gain of the red and green output is reduced by 17% for amplitudes more than 80% of the nominal amplitude. This shifts white towards light blue.

A black stretch function (switchable by IIC bus) stretches video signals with a black level which is higher than the clamping level towards black. Therefore the peak dark value of the video signal is stored. The height of the peak dark value determines the amount of stretch (diagram at 11.6). The screen area in which the peak dark detector is enabled is programmable by IIC bus. So it is possible to screen black borders of the picture (e.g. letter box format) which otherwise prevent the desired function of black stretch.

An overall luminance output is provided for supplying a circuit for scan velocity modulation. The delay of the RGB outputs to the luminance output is adjustable by IIC bus. So a proper alignment of the video signals and the current in the SVM coil is possible.

## 5.2 Circuit description

The HSYNC is reference for a numeric PLL. This PLL generates a clock which is phase locked to the incoming horizontal sync pulse and exactly 864 times faster than the horizontal frequency. The polarity of the external horizontal sync pulses may be positive (see figure below) or negative. In case of negative polarity the incoming HSYNC signal is automatically inverted for an easier application in VGA or SVGA mode.

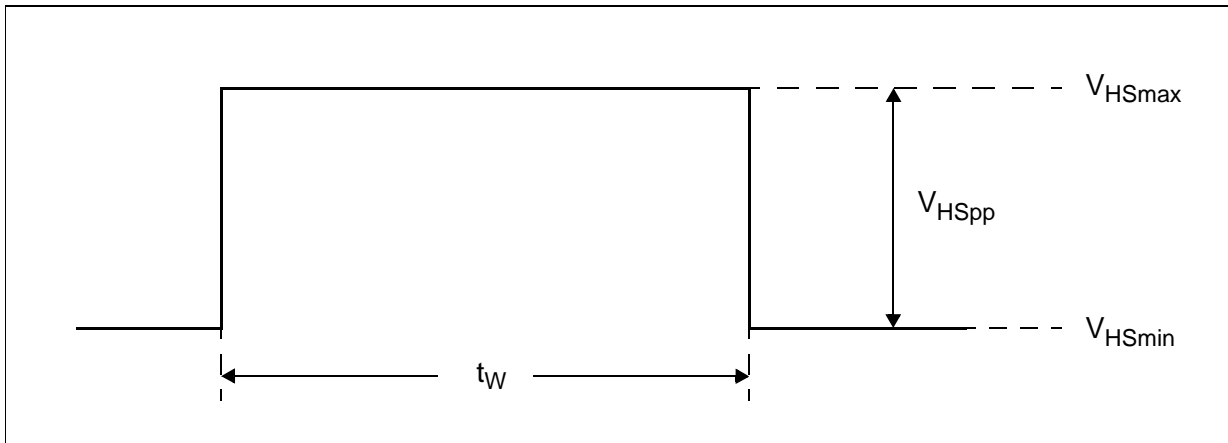

### Incoming signal HSYNC (internal clock)

Pulse width  $t_w$  for I<sup>2</sup>C-bus Bit 'HSWMI'=0:

1.5 $\mu$ s ... 4.5 $\mu$ s (High or Low level)	FH1_2 = High
3.0 $\mu$ s ... 9.0 $\mu$ s (High or Low level)	FH1_2 = Low

Pulse width  $t_w$  for I<sup>2</sup>C-bus Bit 'HSWMI'=1:

0.8 $\mu$ s ... 4.5 $\mu$ s (High or Low level)	FH1_2 = High
1.7 $\mu$ s ... 9.0 $\mu$ s (High or Low level)	FH1_2 = Low

(The specified pulse width depends on the I<sup>2</sup>C-bus bits INCR4...INCR0 resp. PLL clock frequency. The above values are valid for INCR = 6. For higher INCR values the allowed pulse width is decreasing proportional to the increasing PLL clock frequency.)

The described input signal is first applied to an A/D converter. Conversion takes place with 7 bits and a nominal frequency of 27 MHz. The digital PLL uses a low pass filter to obtain defined slopes for further measurements (PAL/NTSC applications). In addition the actual high and low level of the signal as well as a threshold value is evaluated and used to calculate the phase error between internal clock and external horizontal sync pulse. By means of digital PI filtering an increment is gained from this. The PI filter can be set by the I<sup>2</sup>C-bus VCR bit so that the lock-in behaviour of the PLL is optimal in relation to either the TV or VCR mode. Moreover it is possible to adapt the nominal frequency by means of 5 I<sup>2</sup>C-bus bits (INCR4..INCR0) to different horizontal frequencies. An additional bus bit GENMOD offers the possibility to use the PLL as a frequency generator which frequency is controlled by the INCR bits.

---

**System description**

Once an increment has been obtained, either from the PI-filter or the I<sup>2</sup>C-bus, it can be used to operate the Digital Timing Oscillator. The DTO generates a saw-tooth with a frequency that is proportional to the increment. The saw-tooth is converted into a sinusoidal clock signal by means of sin ROM's and D/A converters and applied to an analog PLL which multiplies the frequency by 4 (for detailed explanation see pinning and I<sup>2</sup>C-bus description) and minimizes residual jitter. In this manner the required line locked clock is provided to operate the other functional parts of the circuit. If no HSYNC is applied to pin 18 the system holds its momentary frequency for 2040 lines and following resets the PLL to its nominal frequency. The status bit CON indicates the lock state of the PLL.

The system also provides a stable HS-pulse for internal use. The phase between this internal pulse and the external HSYNC is adjustable via I<sup>2</sup>C bus bits HPHASE. It can be shifted over the range of one TV line.

An external clock (CLKI) can be provided by pin selection (CLEXT = H) or I<sup>2</sup>C control (SCLIIC = H, CLEXTIIC = H). This is recommended when using the SDA 9380 with a scan rate conversion system. The clock frequency has to be  $864 \cdot f_{\text{HSYNC}}$ . The external clock mode can not be used with 18.75, 33.75kHz, 35kHz and 38kHz line frequency. Therefore switching to external clock mode is only possible when INCR = 6, but always allowed during operating without any danger for the H-output stage.

The input signal at VSYNC is the vertical time reference. It has to pass a window avoiding too short or long V-periods in the case of distorted or missing VSYNC pulses. The window allows a VSYNC pulse only after a minimum number of lines from its predecessor and sets an artificial one after a maximum number of lines. The window size is programmable by I<sup>2</sup>C-bus.

Values which influence shape and amplitude of the output signals are transmitted as reduced binary values to the SDA 9380 via I<sup>2</sup>C bus. A CPU which is designed for speed reasons in a pipe line structure calculates in consideration of feedback signals (e.g. IBEAM) values which exactly represent the output signals. These values control after D/A conversion the external deflection and raster correction circuits.

The CPU firmware is stored in an internal ROM.

## System description

## 5.3 Reset modes

The circuit is only completely reset at power-on/off (timing diagram ref. 11.3). If the pin RESN has L-level or during standby operation some parts of the circuit are not affected (timing diagram ref. 11.4):

	Power-On-Reset	External Reset (pin RESN=0)	Standby mode (I <sup>2</sup> C bit STDBY=1)
HD output	High	active	active
H-protection	inactive	active	active
V-protection	inactive	active <sup>1)</sup>	active <sup>1)</sup>
IIC-Interface (SDA, SCL)	tristate	ready	ready
IIC-Register 01..1C	set to default values	set to default values	set to default values
IIC-Register 00, 1D...30h	set to default values	not affected	not affected
Status bit PONRES	set to 1 <sup>2)</sup>	set to 1	not affected
VREFH	not affected	not affected	inactive
CPU	inactive	inactive	inactive

<sup>1)</sup>: inactive if HPROT < V2 (typ. 1.5V)

<sup>2)</sup>: can only be read after Power-On-Reset is finished

**Note:** Power-On-Reset state is deactivated after ca. 32768 cycles of the X1/X2 oscillator clock. RESN=Low and standby state are deactivated after ca. 42 cycles of the CLL clock.

## 5.4 Frequency ranges

H	V	n <sub>L</sub>
15.625 kHz	50 Hz	625 I
15.75 kHz	60 Hz	525 I
18.75 kHz*	60 Hz	625 I
31.25 kHz	50 Hz 100 Hz	625 NI / 1250 I 625 I
31.5 kHz	60 Hz 70 Hz 120 Hz	525 NI / 1050 I 449 NI 525 I
33.75 kHz*	60 Hz	1125 I
35 kHz*	66.7 Hz	525 NI
38 kHz*	60 Hz 72 Hz	632 NI 525 NI

\*) only with internal clock generation

The allowed deviation of all input line frequencies is max. ±4.5%.

n<sub>L</sub> : number of lines per frame

## System description

I : interlaced

NI : non interlaced

If NSA = 0 (subaddr. 01/D5) number of lines per field is selfadaptable between 192 and 680 for each specified H-frequency.

## 5.5 I<sup>2</sup>C-Bus control

### 5.5.1 I<sup>2</sup>C-Bus address

1	0	0	0	1	1	0
---	---	---	---	---	---	---

### 5.5.2 I<sup>2</sup>C-Bus format

write:

S	1	0	0	0	1	1	0	0	A	Subaddress	A	Data Byte	A	*****	A	P
---	---	---	---	---	---	---	---	---	---	------------	---	-----------	---	-------	---	---

read:

S	1	0	0	0	1	1	0	1	A	Status byte	A	Data Byte n	A	*****	NA	P
---	---	---	---	---	---	---	---	---	---	-------------	---	-------------	---	-------	----	---

Reading starts at the last write address n. Specification of a subaddress in reading mode is not possible.

S: Start condition

A: Acknowledge

P: Stop condition

NA: Not Acknowledge

An automatically address increment function is implemented.

After switching on the IC, all bits are set to defined states.

## System description

5.5.3 I<sup>2</sup>C-Bus commands

Control item (for deflection)	Sub- addr.	D7	D6	D5	D4	D3	D2	D1	D0	Allowed range	Effective range	Default value	Disabled by	Default value if disabled	Resolu- tion
Deflection control 0	00	see below								-	-	0	-	-	-
Deflection control 1	01	see below								-	-	0	-	-	-
Vertical scroll *)	02	B7	B6	B5	B4	B3	B2	B1	B0	-128..+127	-128..+127	0	-	-	-
Vertical aspect *)	03	B7	B6	B5	B4	B3	B2	B1	B0	-128..+127	-128..+127	0	-	-	-
Vertical shift *)	04	B7	B6	B5	B4	B3	B2	B1	B0	-128..+127	-128..+127	0	-	-	-
Vertical size *)	05	B7	B6	B5	B4	B3	B2	B1	B0	-128..+127	-128..+127	0	-	-	-
Vertical linearity *)	06	B7	B6	B5	B4	B3	B2	B1	B0	-128..+127	-128..+127	0	-	-	-
Vertical S-correction *)	07	B7	B6	B5	B4	B3	B2	B1	B0	-128..+127	-128..+127	0	-	-	-
Vertical EHT compensation *)	08	B7	B6	B5	B4	B3	B2	B1	B0	-128..+127	-128..+127	0	-	-	-
Horizontal size	09	B7	B6	B5	B4	B3	B2	B1	B0	-128..+127	-128..+127	0	-	-	-
Pin phase	0A	B7	B6	B5	B4	B3	B2	B1	B0	-128..+127	-128..+127	0	-	-	-
Pin amp	0B	B7	B6	B5	B4	B3	B2	B1	B0	-128..+127	-128..+127	0	-	-	-
Upper corner pin correction	0C	B7	B6	B5	B4	B3	B2	B1	B0	-128..+127	-128..+127	0	-	-	-
Lower corner pin correction	0D	B7	B6	B5	B4	B3	B2	B1	B0	-128..+127	-128..+127	0	-	-	-
Extreme corner pin correction	0E	B7	B6	B5	B4	B3	B2	B1	B0	-128..+127	-128..+127	0	-	-	-
Horizontal EHT compensation *)	0F	B7	B6	B5	B4	B3	B2	B1	B0	-128..+127	-128..+127	0	-	-	-
Horizontal shift	10	B6	B5	B4	B3	B2	B1	B0	X	-64..+63	-64..+63	0	-	-	1/CLL
Vertical angle	11	B7	B6	B5	B4	B3	B2	B1	B0	-128..+127	-128..+127	0	-	-	-
Vertical bow	12	B7	B6	B5	B4	B3	B2	B1	B0	-128..+127	-128..+127	0	-	-	-
AFC EHT compensation *)	13	B5	B4	B3	B2	B1	B0	X	X	-32..+31	-32..+31	0	-	-	-
Vertical blanking start*)	14	B3	B2	B1	B0	X	X	X	X	0..+15	0..+15	0	-	-	line
RGB Reference pulse position*)	14	X	X	X	X	B3	B2	B1	B0	0..+15	0..+15	0	BSE = 0	4	line
Horizontal blanking time	15	X	X	B5	B4	B3	B2	B1	B0	0..+63	0..+63	0	BSE = 0	H-flyback	4/CLL
Horizontal blanking phase	16	B5	B4	B3	B2	B1	B0	X	X	-32..+31	-32..+31	0	-	-	4/CLL
Vertical blanking end*)	17	B2	B1	B0	X	X	X	X	X	0..+7	0..+7	0	-	0	line
Guard band *)	17	X	X	X	B4	B3	B2	B1	B0	0..+31	0..+31	0	GBE = 0	3	half line
Vertical sync control	18	see below								-	-	0	-	-	-
Min. No. of lines / field *)	19	B7	B6	B5	B4	B3	B2	B1	B0	0..+255	0..+255	0	-	-	2 lines
Max. No. of lines / field *)	1A	B7	B6	B5	B4	B3	B2	B1	B0	0..+255	0..+255	0	-	-	2 lines
PWM control	1B	see below								-	-	0	-	-	-
PLL control 0	1C	see below								0..+31	6..+21	s. below	-	-	-
PLL control 1	1D	see below								-	-	0	-	-	-
Internal H-sync phase	1E	B7	B6	B5	B4	B3	B2	B1	B0	-128..+127	-96..+119	0	-	-	4/CLL

Control item (for RGB)	Sub- addr.	D7	D6	D5	D4	D3	D2	D1	D0	Allowed range	Effective range	Default value	Resolution
RGB control 0	1F									-	-	0	-
RGB control 1	20									-	-	0	-
RGB control 2	21									-	-	0	-
Video input mode	22									-	-	128	-
Brightness	23	B7	B6	B5	B4	B3	B2	B1	B0	-128..+127	-128..+127	0	-
Contrast	24	B7	B6	B5	B4	B3	B2	B1	B0	-128..+127	-128..+127	0	-
Saturation	25	B5	B4	B3	B2	B1	B0	X	X	-32..+31	-32..+31	-11	-
Average beam current limit *)	26	B7	B6	B5	B4	B3	B2	B1	B0	-128..+127	-128..+127	0	-
Average beam current limit characteristics	27									-	-	-64	-
Peak drive limit	28									-	-	0	-
RGB control 3	29									-	-	0	-
Peak dark detection top border *)	2A	B7	B6	B5	B4	B3	B2	B1	B0	0..+255	0..+255	16	2 lines
Peak dark detection bottom border *)	2B	B7	B6	B5	B4	B3	B2	B1	B0	0..+255	0..+255	71	4 lines
Peak dark detection left border *)	2C	B3	B2	B1	B0	X	X	X	X	0..+15	0..+15	8	16 pixels
Peak dark detection right border *)	2C	X	X	X	X	B3	B2	B1	B0	0..+15	0..+15	8	16 pixels
White control R *)	2D	B5	B4	B3	B2	B1	B0	X	X	-32..+31	-32..+31	0	-
White control G *)	2E	B5	B4	B3	B2	B1	B0	X	X	-32..+31	-32..+31	0	-
White control B *)	2F	B5	B4	B3	B2	B1	B0	X	X	-32..+31	-32..+31	0	-
D/A	30	B7	B6	B5	B4	B3	B2	B1	B0	-128..+127	-128..+127	0	-
*) see 5.5.5 Explanation of some control items													



---

**System description**

At power on most of the data are zero by default (if not otherwise specified) before transferring individual values via IIC-bus.

Allowed values out of the effective range are limited, e.g. Internal H-sync phase =127 is limited to 119.

There are two bits (BSE, GBE) in the deflection control byte 1 for disabling some control items. If one of these bits is "0", the value of the corresponding control item will be ignored and replaced by the value "default value if disabled" in the table above.

### 5.5.4 Detailed description

The **Deflection control byte 0** includes the following bits:

VOFF	STDBY	MON	SCLIIC	RIBM	CLEXTIIC	HDDC	HDE
------	-------	-----	--------	------	----------	------	-----

- VOFF: Vertical off  
0: normal vertical output due to control items  
1: vertical saw-tooth is switched off, vertical protection is disabled
- STDBY: Stand-by mode  
0: normal operation  
1: stand-by mode (all internal clocks are disabled)
- MON: Monitor mode (GENMOD bit must be set to 0)  
0: line frequency must be defined by INCR4..0 (register 1D)  
1: automatic detection of line frequency
- SCLIIC: Select clock by IIC  
0: select clock by pin CLEXT  
1: select clock by IIC bit CLEXTIIC
- RIBM: Input range of IBEAM  
0: 0...2.7V  
1: 1.8...2.7V
- CLEXTIIC: External clock selected by IIC (only effective if bit SCLIIC = 1)  
0: internal clock selected by IIC  
1: external clock selected by IIC
- HDDC: HD duty cycle  
0: duty cycle of output HD is 45%  
1: duty cycle of output HD is 40%
- HDE: HD enable  
0: line is switched off (HD disabled, that is H-level)  
If BSO1 = 1 or BSO0 = 1, no switch-off is possible.  
1: line is switched on (HD enabled)  
Default value depends on pin SSD  
SSD=Low: 0  
SSD=High: 1

## System description

The **Deflection control byte 1** includes the following bits:

BSO1	BSO0	NSA	NCLP	GBE	VDC	JMP	BSE
------	------	-----	------	-----	-----	-----	-----

- BSO1..  
BSO0 Black Switch-Off behaviour  
00: no Black Switch-Off  
01: Black Switch-Off mode 1 (see section 11.2)  
10: Black Switch-Off mode 2 (see section 11.2)  
11: Black Switch-Off mode 3 (see section 11.2)
- NSA: No self adaptation  
0: self adaptation on  
1: self adaptation off
- NCLP: No clipping of vertical and east/west drive signals  
0: Clipping of vertical and east/west drive signals in vertical zoom mode (vertical aspect > 0) to reduce power consumption  
1: No clipping in vertical zoom mode (vertical aspect > 0)
- GBE: Guard band enable  
0: control item for guard band is disabled  
1: control item for guard band is enabled
- VDC: Vertical dynamic compensation  
0: influence of the beam current input IBEAM on the vertical saw-tooth is static (‘zooming’ correction)  
1: influence of the beam current input IBEAM on the vertical saw-tooth is dynamic (‘ripple’ correction)
- JMP: Jump of vertical drive up to overscan position in vertical shrink mode  
0: complete reduction of the vertical drive in shrink mode (vertical aspect < 0)  
1: no reduction of the vertical drive in shrink mode (vertical aspect < 0) during RGB reference pulse lines
- BSE: Blanking select enable  
0: control items for blanking times are disabled  
1: control items for blanking times are enabled

## System description

The **Vertical sync control byte** includes the following bits:

X	X	SSC	X	NI	X	X	X
---	---	-----	---	----	---	---	---

- SSC: Sandcastle without VBL  
0: output SCP with VBL component  
1: output SCP without VBL component
- NI: Non interlace  
0: interlace depends on source  
1: no interlace

The **PWM control byte** includes the following bits:

PWMC5	PWMC4	PWMC3	PWMC2	PWMC1	PWMC0	PWMS1	PWMS0
-------	-------	-------	-------	-------	-------	-------	-------

- PWMS1..  
PWMS0: PWM select  
x0: same duty cycle in each line selected (adjustable by PWMC)  
01: positive V-parabola after external integration available (amplitude adjustable by PWMC)  
11: negative V-parabola after external integration available (amplitude adjustable by PWMC)
- PWMC5..  
PWMC0: PWM control  
These bits control either the duty cycle or the parabola amplitude depending on PWMS0 according to the following table (if PWMS0 = 0 also PWMS1 defines the the duty cycle):

PWMC5...PWMC0	Duty cycle (PWMS0 = 0)	Amplitude of V-parabola (ext. integration, PWMS0 = 1)
100000	PWMS1/108	$0.46 * (V_{OH} - V_{OL})^1$
110000	$(32 + PWMS1)/108$	$0.58 * (V_{OH} - V_{OL})^1$
000000	$(64 + PWMS1)/108$	$0.69 * (V_{OH} - V_{OL})^1$
010000	$(96 + PWMS1)/108$	$0.81 * (V_{OH} - V_{OL})^1$
011111	1	$0.91 * (V_{OH} - V_{OL})^1$

<sup>1)</sup> V<sub>OH</sub>: PWM output High level, V<sub>OL</sub>: PWM output Low level

The PWM output may be used as switching output when PWMS0 = 0. If PWMC = 100000 and PWMS1 = 0 the output is Low. If PWMC = 011111 the output is continuously High.

## System description

The **PLL control byte 0** includes the following bits:

0	0	X	INCR4	INCR3	INCR2	INCR1	INCR0
---	---	---	-------	-------	-------	-------	-------

- INCR4..0: Nominal PLL output frequency  
 $INCR = INT((FH * 55296) / FQ - 64.625)$   
 (for typical values see table below)  
 specified range:  $6 \leq INCR \leq 21$   
 (FQ=24.576MHz)

Application	FH[Hz]	INCR	FH1_2
PAL (50Hz)	15625	6	Low
NTSC (60Hz)	15750	6	Low
PAL (60Hz)	18750	20	Low
PAL (100Hz)	31250	6	High
NTSC (120Hz)	31500	6	High
ATV	32400	8	High
MUSE	33750	11	High
Macintosh (640*480*67Hz)	35000	14	High
SVGA (800*600*60Hz)	38000	21	High

Internal default value: INCR = 6 if FH1\_2 = High  
 INCR = 6 if FH1\_2 = Low, SSD = Low  
 INCR = 20 if FH1\_2 = Low, SSD = High  
 Default value read by IIC bus: INCR = 0

The **PLL control byte 1** includes the following bits:

0	0	0	GENMOD	VCR	NOISY VCR	HSWMI	TC_3RD
---	---	---	--------	-----	--------------	-------	--------

- GENMOD: Clock generator mode  
 0: normal PLL mode  
 1: generator mode (fixed frequency output, controlled by INCR..)
- VCR: PLL filter optimized for  
 0: TV mode  
 1: VCR mode

## System description

- NOISYVCR: Handling of noisy input signals in VCR mode
  - 0: normal handling
  - 1: improved handlingNote: this bit is don't care if bit VCR = 0 (TV mode)
  
- HSWMI: Minimum width of HSYNC
  - 0: 1.5 $\mu$ s
  - 1: 0.8 $\mu$ s
  
- TC\_3RD: Third time constant
  - 0: slow VCR time constant
  - 1: fast VCR time constantNote: this bit is don't care if bit VCR = 0 (TV mode)

**Warnings/Notes:**

- 1) A change of INCR causes changes of the generated clock frequency more than the specified 4.5%.  
Switching from PLL mode to Generator mode (GENMOD) with constant INCR values does not result in exceeding the specified frequency deviation range.
- 2) If pin SSD has H-level the output signal HD starts immediately after power on. In this case the starting horizontal frequency is 31.25kHz (if FH1\_2 = High). Starting with other frequencies requires L-level at SSD so that INCR can be changed before enabling HD with HDE=1.
- 3) When SSD = High and FH1\_2 = Low the horizontal frequency is fixed to 18.75 kHz (INCR = 20) and cannot be changed via I<sup>2</sup>C bus. Other H-frequencies in the range of 15.6 kHz to 19 kHz are possible when SSD = Low.
- 4) The timing of the built-in soft start circuit (starting frequency, period, ending frequency) depends on INCR. The starting frequency of the output HD is approx. 1.71\* FH, the frequency stops at FH defined by INCR (see table on previous page) The total soft start takes about 2.66\*10<sup>3</sup>/FH. If the frequency of the HSYNC input signal is outside the lock range of the PLL (+/- 4.5%), that means the PLL cannot lock, the timing of the soft start may change max. +/- 4.5% due to the unlocked PLL.

## System description

The **RGB control byte 0** includes the following bits:

IN2NOM	IN1NOM	CONTB	BD	VINP2E	FBL2E	VINP1E	FBL1E
--------	--------	-------	----	--------	-------	--------	-------

- IN2NOM: Nominal saturation and contrast for video input 2  
 0: variable saturation and contrast for video input 2 (defined by reg. 24, 25)  
 1: fixed saturation and contrast for video input 2 (nominal values)
- IN1NOM: Nominal saturation and contrast for video input 1  
 0: variable saturation and contrast for video input 1 (defined by reg. 24, 25)  
 1: fixed saturation and contrast for video input 1 (nominal values)
- CONTB: Continuous blanking  
 0: off  
 1: on
- BD: Blanking disable  
 0: horizontal and vertical blanking enabled  
 1: horizontal and vertical blanking disabled
- VINP2E, FBL2E, VINP1E, FBL1E: Selection of input signals (see table below)

VINP2E	FBL2E	VINP1E	FBL1E	selected input signals
0	0	0	0	YUV/RGB 0
0	0	0	1	RGB/YUV 1 when FBL1=High else YUV/RGB 0
0	0	1	X	RGB/YUV 1
0	1	0	0	RGB2 when FBL2=High else YUV/RGB 0
0	1	0	1	RGB2 when FBL2=High else RGB/YUV 1 when FBL1=High else YUV/RGB 0
0	1	1	X	RGB2 when FBL2=High else RGB/YUV 1
1	X	X	X	RGB 2

## System description

The **RGB control byte 1** includes the following bits:

BLUES	SLBLKS	BLCKS	CTLDP	WHITD	CATH2	CATH1	CATH0
-------	--------	-------	-------	-------	-------	-------	-------

- BLUES: Blue stretch  
0: off  
1: on
- SLBLKS: Slow Black stretch  
0: short time constant  
1: long time constant
- BLCKS: Black stretch  
0: off  
1: on
- CTLDP: Control loop disable  
0: cut off and white level control loop are active  
1: cut off and white level control loop are inactive (halt mode)
- WHITD: White level control loop disable  
0: white level control loop is active  
1: white level control loop is inactive (halt mode)
- CATH2..  
CATH0: Cathode drive level (see 5.5.5 Explanation of some control items)  
100: minimum level  
..  
011: +100% (maximum level)

The **RGB control byte 2** includes the following bits:

BLUEB	FBL2L	COR1	COR0	DELOFF	SVMOFF	DEL1	DEL0
-------	-------	------	------	--------	--------	------	------

- BLUEB: Blue background  
0: off  
1: on
- FBL2L: FBL2 input switching level  
0: high switching levels  
1: low switching levels



## System description

- COR1..0: Contrast reduction of the channel 0 and 1 at FBL2
  - 00: 0 %
  - 01: 25 %
  - 10: 50 %
  - 11: 75 %
  
- DELOFF: Delay from SVM output to RGB output
  - 0: delay on (see below)
  - 1: delay off (basic delay = 15ns)
  
- SVMOFF: SVM output
  - 0: active (Y signal at SVM output)
  - 1: off (SVM output is high)
  
- DEL1..0: Delay from SVM output to RGB output
  - 00: delay = 25ns
  - .. ..
  - 11: delay = 55ns

The **Video input mode** includes the following bits:

RGBEN1	MAT11	MAT10	0	RGBEN0	MAT01	MAT00	YLL
--------	-------	-------	---	--------	-------	-------	-----

- RGBEN1: RGB/YUV 1 input
  - 0: YUV input
  - 1: RGB input
  
- MAT11..0: RGB/YUV 1 input, YUV input standard
  - 00: PAL/SECAM
  - 01: NTSC/Jap.
  - 10: NTSC/US
  - 11: HDTV
  
- RGBEN0: YUV/RGB 0 input
  - 0: YUV input
  - 1: RGB input
  
- MAT01..0: YUV/RGB 0 input, YUV input standard
  - 00: PAL/SECAM
  - 01: NTSC/Jap.
  - 10: NTSC/US
  - 11: HDTV

## System description

- YLL: Y0 input low level for PAL and NTSC matrices
  - 0: 1 V (black-to-white value)
  - 1: 0.7 V (black-to-white value)

The **Average beam current limit characteristics** includes the following bits:

GAIN2	GAIN1	GAIN0	TUP1	TUP0	TDOWN1	TDOWN0	MODE
-------	-------	-------	------	------	--------	--------	------

- GAIN2..0: Gain adjustment
  - 100: 0.25
  - 101: 0.375
  - 110: 0.5 (default value)
  - 111: 0.625
  - 000: 0.875
  - 001: 1.125
  - 010: 1.5
  - 011: 2
  
- TUP1..0: Time constant of increasing contrast/brightness (current contrast is lower than the adjusted contrast by I<sup>2</sup>C, ABLIM is not exceeded)
  - 10: approximately 0.25 second
  - 11: approximately 0.5 second
  - 00: approximately 1 second
  - 01: approximately 2 second
  
- TDOWN1..0: Time constant of decreasing contrast/brightness when ABLIM is exceeded
  - 10: approximately 30 ms
  - 11: approximately 60 ms
  - 00: approximately 120 ms
  - 01: approximately 240 ms
  
- MODE: Updating of contrast/brightness
  - 0: with field frequency
  - 1: with line frequency



## System description

The **Status byte** includes the following bits:

HPON	VPON	CON	H38K	H35K	CLOW	-	PONRES
------	------	-----	------	------	------	---	--------

- HPON: H-protection on  
0: normal operation of the line output stage  
1: upper threshold on input HPROT has been exceeded \*)
- VPON: V-protection on  
0: normal operation of the vertical output stage  
1: incorrect signal on input VPROT has been detected \*)
- CON: Coincidence not  
0: H-coincidence detected  
1: no H-coincidence detected
- H38K: 38 kHz line frequency  
0: 38 kHz line frequency not detected  
1: 38 kHz line frequency detected
- H35K: 35 kHz line frequency  
0: 35 kHz line frequency not detected  
1: 35 kHz line frequency detected
- CLOW: Control loop out of window  
0: all control loops inside of window  
1: one of the control loop out of window
- PONRES: Power On Reset  
0: after bus master has read the status byte  
1: after each detected reset

\*) Also output PROTON (pin 35) goes High if HPON=1 or VPON=1.

**Note!** **PONRES is reset after this byte has been read.**

## System description

## 5.5.5 Explanation of some control items

- Vertical aspect, Vertical scroll:** Two special control items are implemented for the user to adjust the vertical height (control item: Vertical aspect) and the vertical position (Vertical scroll). These items may be stored for every display mode to get an individual height and position if desired. Changing these parameters automatically influences the outputs VD+, VD-, E/W, HD in such a way that absolutely no raster distortion happens. There is no need for the user to re-adjust any geometry parameter.
- The difference of the function of **Vertical size** and **Vertical aspect** is the following: Varying Vertical size causes a linear stretching of the saw-tooth to eliminate the tolerance of linear components (e.g. feedback resistor). But adjusting Vertical aspect takes into consideration that more or less picture height needs very more or less S-correction (no linear relation). Therefore **Vertical aspect** should be used for changing the aspect ratio (e.g. 16:9 source on 4:3 CRT) or if an individual picture height is desired for the various PC graphic standards. Vertical aspect = -128(minimum value) results in a vertical reduction to 37.5%.
- Vertical size, Vertical shift:** The purpose of these control parameters is the alignment in the factory and service to adapt the output signals VD+, VD- to the picture tube and to eliminate tolerances of the hardware and deflection yoke. Only one set of these parameters is required for all display modes.
- Vertical linearity, Vertical S-correction:** Changing the vertical linearity and S-correction has no influence on the E/W-geometry. That means, straight vertical lines remain straight. The output signals E/W and HD are automatically changed so no re-adjustment of the related control items is needed. This feature saves time for adjustment of the so called 'smart' mode (4:3 source on 16:9 CRT)
- Guard band:** This control item is useful for optimizing self adaptation. Video signals with different number of lines in consecutive fields (e.g. VCR search mode) must not start the procedure of self adaptation. But switching between different TV standards has to change the slope of the vertical saw-tooth getting always the same amplitude (self adaptation). To avoid problems with flicker free TV systems which have alternating number of lines per field an average value of four consecutive fields is calculated. If the deviation of these average values (e.g. PAL : 312.5 lines or 625 half lines) is less or equals **Guard band**, no adaptation takes place. When it exceeds **Guard band**, the vertical slope will be changed.
- Vertical EHT comp.:** This item controls the influence of the beam current dependent input signal IBEAM on the outputs VD+ and VD- according to the following equation:

$$\Delta V_{VDPP} = \Delta V_{IBEAM} \cdot \frac{\text{Vertical\_EHT\_compensation} + 128}{1536} \cdot 0.59 \quad (\text{if RIBM}=0)$$

$$\Delta V_{VDPP} = \Delta V_{IBEAM} \cdot \frac{\text{Vertical\_EHT\_compensation} + 128}{512} \cdot 0.59 \quad (\text{if RIBM}=1)$$

$\Delta V_{VDPP}$  : variation of VD+ and VD-peak-to-peak voltage

## System description

$\Delta V_{\text{IBEAM}}$  : variation of IBEAM input voltage

If Vertical EHT compensation = -128 the outputs VD+ and VD- are independent of the input signal IBEAM.

**Horizontal EHT comp.:** This item controls the influence of the input signal IBEAM on the output E/W according to the following equation:

$$\Delta V_{\text{EW}} = \Delta V_{\text{IBEAM}} \cdot \frac{\text{Horizontal\_EHT\_compensation} + 128}{384} \cdot 2.14 \quad (\text{if RIBM}=0)$$

$$\Delta V_{\text{EW}} = \Delta V_{\text{IBEAM}} \cdot \frac{\text{Horizontal\_EHT\_compensation} + 128}{128} \cdot 2.14 \quad (\text{if RIBM}=1)$$

$\Delta V_{\text{EW}}$  : variation of E/W output voltage

$\Delta V_{\text{IBEAM}}$  : variation of IBEAM input voltage

If Horizontal EHT compensation = -128 the output E/W is independent of the input signal IBEAM.

**AFC EHT comp.:**

Deviation of the horizontal phase caused by high beam current (e.g. white bar) can be eliminated by this control item. The beam current dependent input signal IBEAM is multiplied by AFC EHT compensation. Additional to the control items Vertical angle, Vertical bow and Horizontal shift, this product influences the horizontal phase at the output HD according to the following equation:

$$\Delta\phi = \Delta V_{\text{IBEAM}} \cdot \frac{\text{AFC\_EHT\_compensation}}{192} \cdot \frac{58}{\text{CLL}} \quad (\text{if RIBM}=0)$$

$$\Delta\phi = \Delta V_{\text{IBEAM}} \cdot \frac{\text{AFC\_EHT\_compensation}}{64} \cdot \frac{58}{\text{CLL}} \quad (\text{if RIBM}=1)$$

$\Delta\phi$  : variation of horizontal phase at the output HD  
(positive values: shift left, negatives values: shift right)

$\Delta V_{\text{IBEAM}}$  : variation of IBEAM input voltage (units: Volt)

CLL :  $864 \cdot f_H$

## System description

**Vertical blanking start (VBS), RGB ref. pulse pos. (RPP), Vertical blanking end (VBE):**

The control item **RPP** defines the position of the three reference pulses for R, G, B:

Red ref. pulse	= <b>RPP</b> + 16; (odd field)	(def. value 20)
Green ref. pulse	= <b>RPP</b> + 17; (odd field)	(def. value 21)
Blue ref. pulse	= <b>RPP</b> + 18; (odd field)	(def. value 22)

If bit **BSE** (Blanking Select Enable) = 0 the control item **RPP** is replaced by its default value (=4). So the R, G, B ref. pulses are generated in line 20, 21, 22 in the odd field resp. line 21, 22, 23 in the even field (see diagram below).

**VBS** defines the start as well of the internal vertical blanking pulse VBL as of the output signal VBLO. The end of the internal signal VBL is defined by **RPP** and **VBE**. This also applies to the end of VBLO with one exception. There is at least one line between the cutoff/white level measurement line for blue and the end of VBLO. The vertical component of the SCP signal is always identical with the internal vertical blanking pulse VBL.

Both VBL as well as VBLO are synchronized with the leading edge of HSYNC. It always starts and stops at the beginning of line and never in the center. Therefore the end and width of VBL is one line more in the even field than in the odd field.

If the vertical drive signals VD+, VD- are clipped in zoom mode (vertical aspect > 0) at the top and bottom of the screen the vertical blanking pulse is extended to blank all lines in this area without any additional programming.

a) Description of VBL when JMP= 0

Start of VBL = **VBS** lines before the first complete line of the next field  
(def. value 0)

if **BSE** = 0

end of VBL = end of line (**VBE** + 22) (odd field)

width of VBL = (**VBS** + **VBE** + 22) lines (odd field)(def. value 22)

After power on the control bit BSE is 0, also VBS = 0 and VBE = 0. Therefore 22 lines (odd field) will be blanked before any programming of the IC.

if **BSE** = 1

end of VBL = end of line (**RPP** + **VBE** + 18) (odd field)

width of VBL = (**VBS** + **RPP** + **VBE** + 18) lines (odd field)

The number of lines between the last ref. pulse and the end of VBL is defined by **VBE** in the range of 0 (**VBE** = 0) to 7 (**VBE** = 7).

If **VBS** = 0 (minimum value) VBL starts (point A in fig. below) 0...0.5 line (new odd field) or 0.5...1 line (new even field) prior to the vertical flyback.

System description

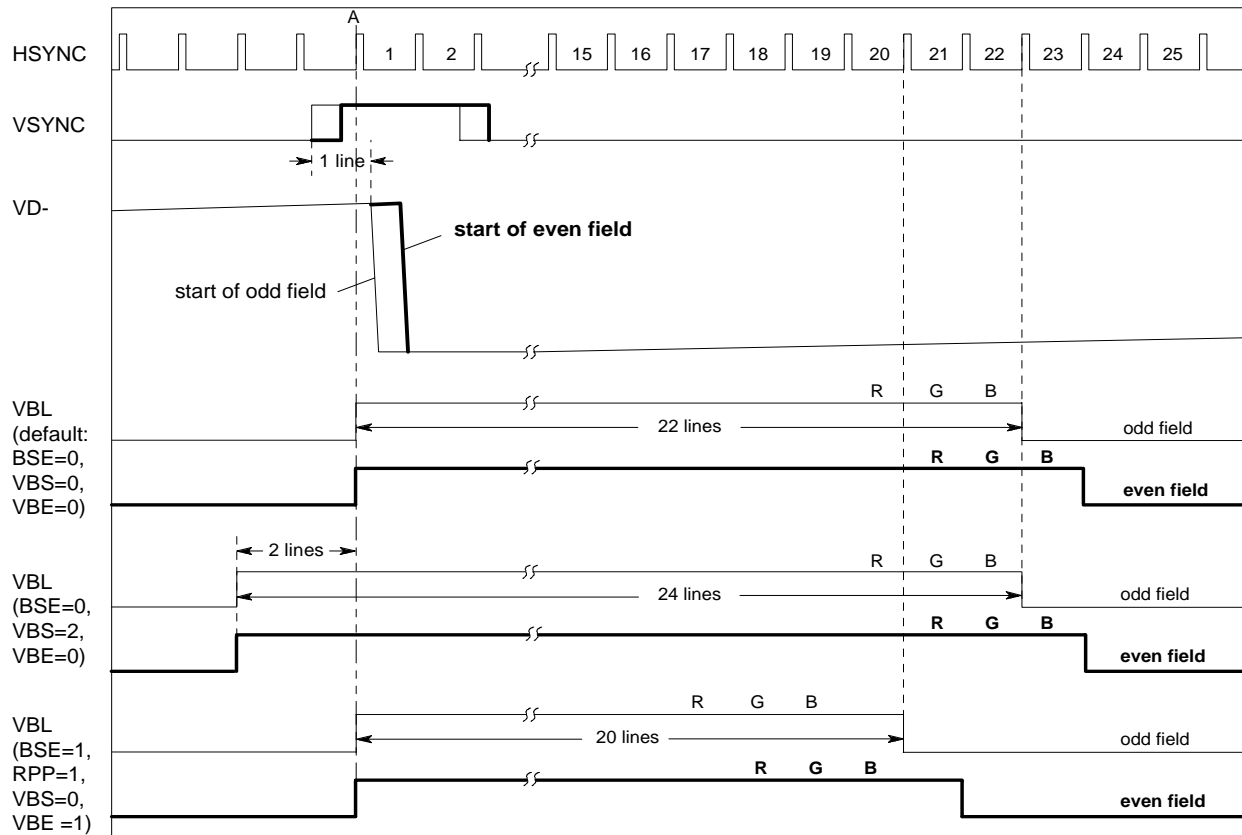

Internal vertical blanking pulse VBL when JMP = 0 and number of lines per field = constant

b) Description of VBL when JMP= 1

Start of VBL = **VBS** lines before the first complete line of the next field  
(def. value 0)

if **BSE = 0**

end of VBL = end of line (**VBE + 29**) (odd field)

width of VBL = (**VBS + VBE + 29**) lines (odd field)(def. value 29)

if **BSE = 1**

end of VBL = end of line (**RPP + VBE + 25**) (odd field)

width of VBL = (**VBS + RPP + VBE + 25**) lines (odd field)

Note! If **JMP = 1** the number of lines between the last ref. pulse and the end of VBL is defined by **VBE** in the range of 7 (VBE = 0) to 14 (VBE = 7).



System description

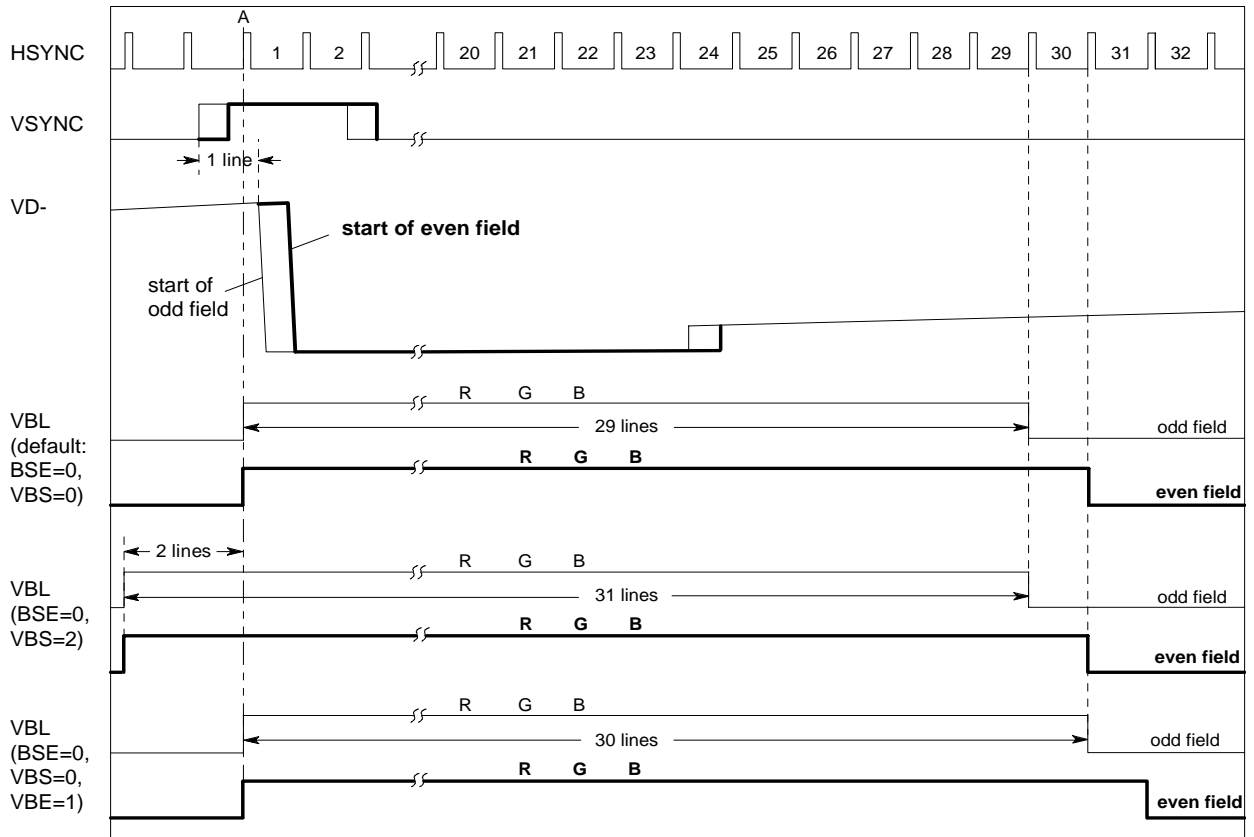

Internal vertical blanking pulse VBL when JMP = 1 and number of lines per field = constant

## System description

**Min. No. of lines / field:**

It defines the minimum number of lines per field for the vertical synchronization. If the TV standard at the inputs VSYNC and HSYNC has less lines per field than defined by **Min. No. of lines / field** no synchronization is possible. The relationship between **Min. No. of lines / field** and the minimum number of lines is given in the following table:

<b>Min. No. of lines / field</b>	<b>minimum number of lines per field</b>
0	192
1	194
...	...
127	446
128	448
...	...
254	700
255	702

**Max. No. of lines / field:**

It defines the maximum number of lines per field for the vertical synchronization. If the TV standard at the inputs VSYNC and HSYNC has more lines per field than defined by **Max. No. of lines / field** no synchronization is possible. The relationship between **Max. No. of lines / field** and the maximum number of lines is given in the following table:

<b>Max. No. of lines / field</b>	<b>maximum number of lines per field</b>
0	702
1	192
2	194
...	...
127	444
128	446
...	...
255	700

**Average beam current limit:**

Brightness and contrast is reduced when the average beam current limit level is exceeded. The beam current is measured at pin IBEAM. High voltage at this input indicates low beam current, low voltage high beam current. The limit range of -128 to 127 complies to a voltage at IBEAM of 2.5 to 0.84V at RIBM = 0 and 2.63 to 2.08V at RIBM = 1.

System description

**Peak dark detection (PDD) top border, bottom border, left border, right border:**

These four control items define the picture area insides the peak dark detector is enabled. The peak dark detector is storing the lowest level of the luminance signal. If this value is higher than the clamping level the luminance signal is stretched towards clamping level (Black stretch function). Those parts of the picture with a luminance signal less than 50% of nominal amplitude are getting more dark.

It is possible with these four control items to screen black borders of the picture (e.g. letter box format) which otherwise prevent the desired function of black stretch.

The following figure and table show their definitions:

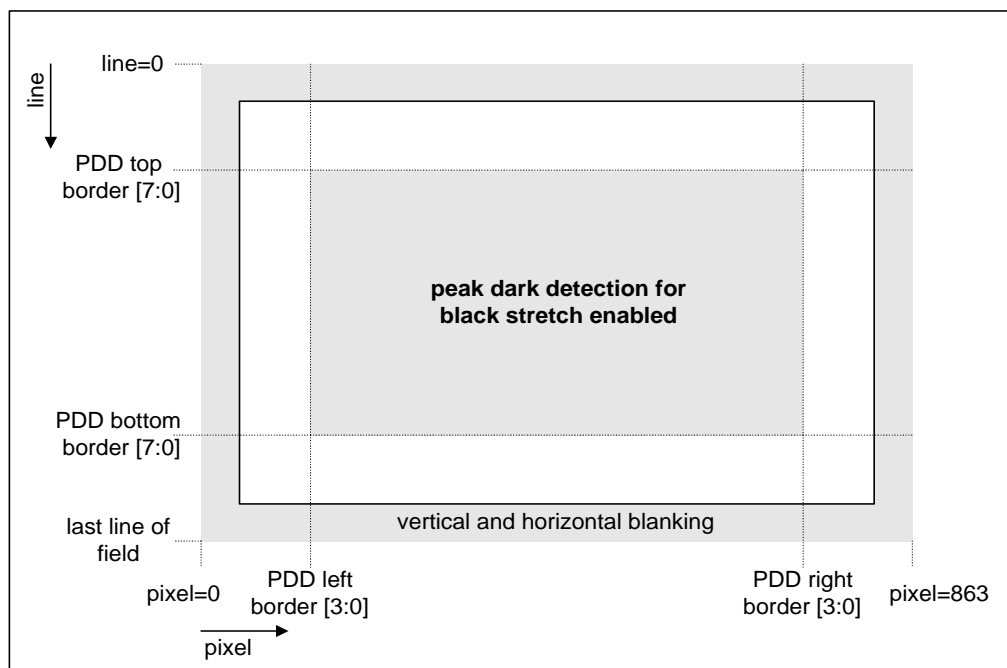

	<b>PDD top border</b>	<b>PDD bottom border</b>	<b>PDD left border</b>	<b>PDD right border</b>
<b>Width</b>	8 bit (0...255)	8 bit (0...255)	4 bit (0...15)	4 bit (0...15)
<b>Resolution</b>	2 lines/bit	4 lines/bit	16 pixels/bit	16 pixels/bit
<b>Range</b>	line 0...510	line 0...1020	pixel 64...304	pixel 576...816
<b>Default value</b>	16 (line 32)	71 (line 284)	8 (pixel 192)	8 (pixel 704)

## System description

**White control R, white control G, white control B, CATH[2:0]:**

These four control items define the nominal values of the cut-off and white-drive currents during the measurement lines. They can be calculated with the following equations:

$$I_{\text{cut-off}} = 0.00325 * (\text{White control } x + 64) / R_{\text{DCI}} \quad (\text{if } R_{\text{DCI}}=0)$$

$$I_{\text{cut-off}} = 0.00108 * (\text{White control } x + 64) / R_{\text{DCI}} \quad (\text{if } R_{\text{DCI}}=1)$$

$$I_{\text{white-drive}} = I_{\text{cut-off}} * (\text{CATH}[2:0] + 18) / 8$$

White control x: White control register for R, G or B (range -32...+31)

$R_{\text{DCI}}$ : Resulting resistor to ground at DCI input

CATH[2:0]: Cathode drive level (range -4...+3) in register RGB control 1

## System description

## Most important V-Deflection modes for 4:3 CRT

Mode	Description	Characteristics	Notes	Vertical scroll	Vertical aspect	BSE	GBE	WHITD	JMP
N0	normal mode (for 4:3 source, Letterbox) with <b>default</b> settings	RGB ref. pulse position = line 20... 22 (odd field) end of V-blanking = line 22 (odd field) guard band = 1.5 lines	mode after power on	0	0	0	0	0	0
N1	normal mode (for 4:3 source, Letterbox) with <b>user defined</b> settings	RGB ref. pulse position = line <b>(RPP + 16)</b> ... <b>(RPP + 18)</b> (odd field) end of V-blanking = line <b>(RPP + 18)</b> (odd field) guard band = <b>Guard band/2</b> [lines]	RGB reference pulse position adjustable, guard band adjustable	0	0	1	1	0	0
VGA	VGA or SVGA mode with <b>user defined</b> V-position/V-size	RGB ref. pulse position = line 20... 22 (odd field) end of V-blanking = line 22 (odd field) guard band = 1.5 lines	Vertical scroll/Vertical aspect for user defined V-position/V-size, WHITD disables RGB white level ref. pulses	variable	variable	0	0	1	0
S0	shrink mode 75% (for 16:9 source) with <b>default</b> settings	RGB ref. pulse position = line 20... 22 (odd field) end of V-blanking = line 22 (odd field) guard band = 1.5 lines	Vertical aspect = -50 causes V-reduction to 75%, JMP = 0 causes V-shrink incl. flyback	0	-50	0	0	0	0
S1	shrink mode 75% (for 16:9 source) with <b>user defined</b> settings	RGB ref. pulse position = line <b>(RPP + 16)</b> ... <b>(RPP + 18)</b> (odd field) end of V-blanking = line <b>(RPP + VBE + 25)</b> (odd) start of reduced V-ramp = line <b>(RPP + 19)</b> (odd) guard band = <b>Guard band/2</b> [lines]	RGB ref. pulse position adjust., JMP = 1 causes V-shrink excl. flyback, WHITD disables RGB white level ref. pulses guard band adjustable	0	-50	1	1	1	1

## System description

## Most important V-Deflection modes for 16:9 CRT

Mode	Description	Characteristics	Notes	Vertical scroll	Vertical aspect	BSE	GBE	WHITD	JMP
N0	normal mode (for 16:9 or 4:3 source) with <b>default</b> settings	RGB ref. pulse position = line 20... 22 (odd field) end of V-blanking = line 22 (odd field) guard band = 1.5 lines	mode after power on	0	0	0	0	0	0
N1	normal mode (for 16:9 or 4:3 source) with <b>user defined</b> settings	RGB ref. pulse position = line <b>(RPP + 16)</b> ... <b>(RPP + 18)</b> (odd field) end of V-blanking = line <b>(RPP + 18)</b> (odd field) guard band = <b>Guard band/2</b> [lines]	RGB reference pulse position adjustable, guard band adjustable	0	0	1	1	0	0
Z	zoom mode (for 4:3 source, Letterbox)	RGB ref. pulse position = line 20... 22 (odd field) end of V-blanking = line 22 (odd field) zoom factor ca. <b>Vertical aspect/2</b> [%] guard band = 1.5 lines	Vertical aspect controls zoom factor, clipping of VD+, VD-, E/W when NCLP = 0	0	> 0	0	0	0	0
SC	scroll mode (for 4:3 source, Letterbox with subtitles)	RGB ref. pulse position = line 20... 22 (odd field) end of V-blanking = line 22 (odd field) zoom factor ca. <b>Vertical aspect/2</b> [%] guard band = 1.5 lines	as above, Vertical scroll can be additionally used for adjustment of vertical position	variable	> 0	0	0	0	0
S2	shrink mode 66% (for two 4:3 sources) with <b>default</b> settings	RGB ref. pulse position = line 20... 22 (odd field) end of V-blanking = line 22 (odd field) guard band = 1.5 lines	Vertical aspect = -68 causes V-reduction to 66%, JMP = 0 causes V-shrink incl. flyback	0	-68	0	0	0	0
S3	shrink mode 66% (for two 4:3 sources) with <b>user defined</b> settings	RGB ref. pulse position = line <b>(RPP + 16)</b> ... <b>(RPP + 18)</b> (odd field) end of V-blanking = line <b>(RPP + VBE + 25)</b> (odd) start of reduced V-ramp = line <b>(RPP + 19)</b> (odd) guard band = <b>Guard band/2</b> [lines]	RGB ref. pulse position adjust., JMP = 1 causes V-shrink excl. flyback, WHITD disables RGB white level ref. pulses guard band adjustable	0	-68	1	1	1	1
S4	shrink mode 50% (for two 16:9 sources) with <b>default</b> settings	RGB ref. pulse position = line 20... 22 (odd field) end of V-blanking = line 22 (odd field) guard band = 1.5 lines	vertical aspect = -102 causes V-reduction to 50%, JMP = 0 causes V-shrink incl. flyback	0	-102	0	0	0	0

6 Pin schematic

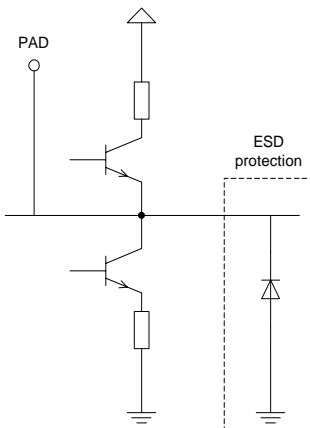
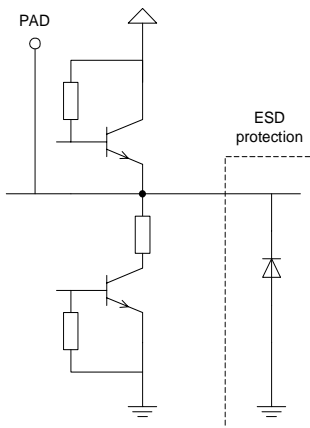
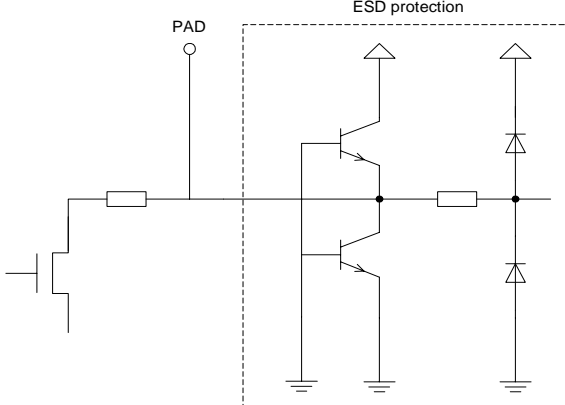
pin	schematic	remark
ROUT, GOUT, BOUT		bipolar output stage, supply voltage: $V_{DD(MC)}$
SCP		bipolar output stage, supply voltage: $V_{DD(MC)}$
HD		open drain output

Pin schematic

pin	schematic	remark
X1, X2		crystal oscillator (X1: input, X2: output)
SVM		analog output
CLKI, CLEXT, TEST, RESN, SCL, SDA, H35K, H38K, PWM, VSYNC, FH1_2, HSYNC, PHI2, PROTON, VBLO, FBL1, FBL2, SWITCH		digital input/ output



Pin schematic

pin	schematic	remark
E/W, D/A, VD+, VD-, VPROT, HPROT, HSAFE, BSOIN, IBEAM, VREFH, VREFN, VREFC, DCI, Y/R0, U/G0, V/B0, Y/R1, U/G1, V/B1, R2, G2, B2		analog input/ output

## Absolute maximum ratings

## 7 Absolute maximum ratings

Parameter	Symbol	Min	Max	Unit	Remark
Operating temperature	$T_A$	0	70	°C	
Storage temperature		-40	125	°C	
Junction temperature			125	°C	
Soldering temperature			260	°C	
Input voltage		$V_{SS}-0.3V$	$V_{DD}+0.3V$		not valid for SDA, SCL, CLKI, HD
Input voltage		$V_{SS}-0.3V$	5.5V		SDA, SCL, CLKI, HD
Output voltage		$V_{SS}-0.3V$	$V_{DD}+0.3V$		
Supply voltages	$V_{DD(D)}$ $V_{DD(A1..4)}$	-0.3	3.8	V	
Supply voltage	$V_{DD(MC)}$	-0.3	9	V	
Supply total voltage difference		-0.25	0.25	V	between $V_{DD(D)}$ , $V_{DD(A1..4)}$
VSS, SUBST total voltage difference		-0.25	0.25	V	between SUBST, $V_{SS(MC)}$ , $V_{SS(D)}$ , $V_{SS(A1..4)}$
Total power dissipation			1.28	W	
Latch-up protection		-100	100	mA	all inputs/outputs

Absolute Maximum Ratings are those values beyond which damage to the device may occur. Functional operation under these conditions or at any other condition beyond those indicated in the operational sections of this specification is not implied.

## Recommended operating conditions

## 8 Recommended operating conditions

Parameter	Symbol	Min	Nom	Max	Unit	Remark
Supply voltages	$V_{DD(D)}$ $V_{DD(A1..4)}$	3.0	3.3	3.45	V	<sup>1)</sup>
Supply voltage	$V_{DD(MC)}$	7.2	8.0	8.4	V	<sup>1)</sup>
Ambient temperature	$T_A$	0	25	70	°C	

<sup>1)</sup> Any sequence and any rise time of the 3.3V and 8V supply voltage is allowed at power on. But all VSS pins as well as SUBST pin have to be connected to ground when applying any voltage.

**TTL Inputs: VSYNC, RESN, TEST, FH1\_2, CLEXT, SSD**

High-level input voltage	$V_{IH}$	2.0V		$V_{DD}$	V	
Low-level input voltage	$V_{IL}$	0		0.8	V	

**TTL Inputs: CLKI (CLEXT=High)**

High-level input voltage	$V_{IH}$	2.0V		5.5	V	
Low-level input voltage	$V_{IL}$	0		0.8	V	

**Input VPROT**

Threshold V1		1.4	1.5	1.6	V	
Threshold V2		0.9	1.0	1.1	V	

**Input HPROT**

Threshold V1		2.65	2.7	2.75	V	
Threshold V2		1.4	1.5	1.6	V	

**Input BSOIN**

Upper threshold (negative-going)	$V_{THn}$	2.625	2.675*	2.725	V	see 11.2
Upper threshold (positive-going)	$V_{THp}$	2.725	2.775*	2.825	V	
Lower threshold			0.5	0.7	V	

\*) The comparator has a hysteresis of typ. 100mV.

**Input HSAFE**

Low input voltage			1.8		V	
Full range input voltage			2.7		V	
Input voltage at 31.25 kHz	$V_{31.25k}$	1.9	2.0	2.1	V	
Input voltage at 38 kHz	$V_{38k}$	1.225	1.24	1.26	$V_{31.25k}$	related to $V_{31.25k}$ !

## Recommended operating conditions

Parameter	Symbol	Min	Nom	Max	Unit	Remark
Input voltage when watching of HSAFE is disabled		0		1.5	V	

**Input IBEAM**

Low input voltage			0		V	control bit RIBM=0
			1.8		V	control bit RIBM=1
Full range input voltage			2.7		V	RIBM=0
			2.7		V	RIBM=1

**Reference Voltage Pins**

VREFH voltage		1.568	1.6	1.632	V	tolerance +- 2%
VREFN voltage			0		V	
VREFC resistor to VREFN			27		k $\Omega$	tolerance +- 2%

**Input  $\Phi 2$** 

Low-level input voltage	$V_{IL}$	0		0.7	V	
High-level input voltage	$V_{IH}$	2.0V		$V_{DD}$		

**Input HSYNC (CLEXT=Low)**

Input voltage range	$V_{HSpp}$	2V		$V_{DD}$		see 5.2
Input voltage Low level	$V_{HSmin}$	0V				see 5.2
Input voltage High level	$V_{HSmax}$			$V_{DD}$		see 5.2
Pulse width (HSWMI=0)	$t_w$	1.5		4.5	$\mu s$	*), FH1_2 = High
		3.0		9.0	$\mu s$	*), FH1_2 = Low
Pulse width (HSWMI=1)	$t_w$	0.8		4.5	$\mu s$	*), FH1_2 = High
		1.7		9.0	$\mu s$	*), FH1_2 = Low

\*) High or Low level allowed, INCR = 6, see 5.2

**Input HSYNC (CLEXT=High)**

Low-level input voltage	$V_{IL}$	0		0.8	V	
High-level input voltage	$V_{IH}$	2.0V		$V_{DD}$		
Setup time	$t_{SU}$	7			ns	referred to rising edge of CLKI
Hold time	$t_H$	6			ns	referred to rising edge of CLKI

## Recommended operating conditions

Parameter	Symbol	Min	Nom	Max	Unit	Remark
<b>Input VSYNC</b>						
Pulse width high		100 ns		100/fH		FH1_2=1, NI=0
Pulse width high		200 ns		100/fH		FH1_2=0, NI=0
Pulse width high		1.5/fH		100/fH		NI=1
<b>Input CLKI (external clock mode, CLEXT=high)</b>						
Input frequency		25	27	30	MHz	
<b>Quartz Oscillator Input / Output X1, X2</b>						
Crystal frequency			24.576		MHz	fundamental crystal type, e.g. Saronix 9922 520 00282
Crystal resonant impedance				40	$\Omega$	
External capacitance			15		pF	see 10
<b>YUV Inputs</b>						
Y input voltage (black-to-white value)	$V_{P-P}$		1 0.7	1.5 1.05	V V	only Y0 input at YLL = 1, or at HDTV matrix
U input voltage (peak-to-peak value)	$V_{P-P}$		1.33 0.7	2 1.05	V V	U = - (B - Y), at HDTV matrix
V input voltage (peak-to-peak value)	$V_{P-P}$		1.05 0.7	1.6 1.05	V V	V = - (R - Y), at HDTV matrix
DC input current between clamping	$I_i$			100	nA	
Input capacitance	$C_i$			7	pF	
Maximum input current during clamping	$I_{i-clamp}$	100			$\mu$ A	
Internal bias during clamping at Y-input	$V_{clampY}$		0.6		V	
Internal bias during clamping at UV-inputs	$V_{clampUV}$		1.1		V	
<b>RGB Inputs (RGB2, RGB/YUV1 if RGBEN1=1, YUV/RGB0 if RGBEN0=1)</b>						
Input voltage (black-to-white value)	$V_{P-P}$		0.7	1	V	
DC input current between clamping	$I_i$			100	nA	
Input capacitance	$C_i$			7	pF	

## Recommended operating conditions

Parameter	Symbol	Min	Nom	Max	Unit	Remark
Maximum input current during clamping	$I_{i-clamp}$	100			$\mu\text{A}$	
Internal bias during clamping	$V_{clamp}$		0.6		V	
Difference between black level of internal and external signals at the outputs	$\Delta V_o$			50	mV	
Delay difference of the three channels	$\Delta t_d$		0		ns	1)

**Fast Blanking Input FBL1 (RGB/YUV 1)**

Input voltage no data insertion	$V_{i-n}$			0.5	V	
Input voltage data insertion	$V_{i-y}$	0.9			V	
Maximum input voltage	$V_{i-max}$			3.3	V	
Difference between transit times for signal switching and signal insertion	$t_s - t_i$			10	ns	1)
Suppression of internal video signals (insertion) or external video signals (no insertion)			55		dB	$f_i = 0$ to 10 MHz, 1)

**Fast Blanking/Contrast Reduction Input FBL2 (RGB2)**

Maximum input voltage	$V_{i-max}$			3.3	V	
Difference between transit times for signal switching and signal insertion	$t_s - t_i$			10	ns	1)
Suppression of internal video signals (insertion) or external video signals (no insertion)			55		dB	$f_i = 0$ to 10 MHz, 1)

**Fast Blanking (Control bit COR1..COR0 = 00)**

Input voltage no data insertion	$V_{i-n}$			0.5	V	
Input voltage data insertion	$V_{i-y}$	0.9			V	

**Fast Blanking and Contrast Reduction (Control bit COR1..COR0 = 01...11)**

Input voltage no contrast reduction of internal RGB signals	$V_{icr-n}$			1.4 0.5	V	FBL2L = 0 FBL2L = 1
Input voltage contrast reduction of internal RGB signals	$V_{icr-y}$	1.7 0.9			V	FBL2L = 0 FBL2L = 1
Contrast reduction (control bit COR1..COR0)		0		75	%	
Input voltage no data insertion	$V_{i-n}$			2 1.2	V	FBL2L = 0 FBL2L = 1

## Recommended operating conditions

Parameter	Symbol	Min	Nom	Max	Unit	Remark
Input voltage data insertion	$V_{i-y}$	2.5 1.8			V	FBL2L = 0 FBL2L = 1

**Dark current input DCI for cut off and white level control**

Low input voltage			0		V	control bit RDCI=0
			1.8		V	control bit RDCI=1
Full range input voltage			2.7		V	
Maximum input current	$I_{i-DCI\max}$	10			mA	$V_{i-DCI} > V_{dd}$

**Input RGB matrices****PAL/SECAM mode**

RGB matrix coefficients: $R = Y - V$ $G = Y + P_u U + P_v V$ $B = Y - U$	$P_u$		0.19			$U = -(B - Y)$ $V = -(R - Y)$
	$P_v$		0.51			

**NTSC/Jap mode**

RGB matrix coefficients: $R = Y + J_{ur}U + J_{vr}V$ $G = Y + J_{ug}U + J_{vg}V$ $B = Y + J_{ub}U$	$J_{ur}$		0.068			$U = -(B - Y)$ $V = -(R - Y)$
	$J_{vr}$		- 1.38			
	$J_{ug}$		0.15			
	$J_{vg}$		0.46			
	$J_{ub}$		- 1			

**NTSC/US mode**

RGB matrix coefficients: $R = Y + A_{ur}U + A_{vr}V$ $G = Y + A_{ug}U + A_{vg}V$ $B = Y + A_{ub}U + A_{vb}V$	$A_{ur}$		0.12			$U = -(B - Y)$ $V = -(R - Y)$
	$A_{vr}$		- 1.32			
	$A_{ug}$		0.25			
	$A_{vg}$		0.42			
	$A_{ub}$		- 1.08			
	$A_{vb}$		0.035			

**HDTV mode (according to SMPTE Standard 274M and EIA-770.3-A)**

RGB matrix coefficients: $R = Y + H_{vr}V$ $G = Y + H_{ug}U + H_{vg}V$ $B = Y + H_{ub}U$	$H_{vr}$		1.575			$U = P'_B =$ $= 0.539 (B - Y)$ $V = P'_R =$ $= 0.635 (R - Y)$
	$H_{ug}$		- 0.187			
	$H_{vg}$		- 0.468			
	$H_{ub}$		1.856			

**Internal RGB matrices**

See PAL/SECAM mode						
--------------------	--	--	--	--	--	--

**Internal colour difference matrices**

See PAL/SECAM mode						
--------------------	--	--	--	--	--	--

## Recommended operating conditions

Parameter	Symbol	Min	Nom	Max	Unit	Remark
<b>Saturation control</b> (control bit B0...B5; subaddress 25h)						
Saturation control range		52			dB	63 steps
Nominal saturation B7...B2 = 110001			0		dB	
<b>Contrast control</b> (control bit B7...B0; subaddress 24h)						
Contrast control range			20		dB	255 steps
Nominal contrast B7...B0 = 00000000			0		dB	
Tracking between the three channels over a control range of 10 dB				0.5	dB	
<b>Brightness control</b> (control bit B7...B0; subaddress 23h)						
Brightness control range			+ 0.75		V	255 steps
<b>Black level stretch</b> (control bit BLCKS; subaddress 20h)						
Maximum black level shift		15	21	27	IRE	
Level shift at 100% peak white		-1	0	1	IRE	
Level shift at 50% peak white		-1		3	IRE	
Level shift at 15% peak white		8	11	14	IRE	
<b>Peak drive limit</b> (control byte peak drive limit, bits B7...B0; bit PDD)						
Peak detector						
Peak detector level (at the R, G or B output at nominal white drive relative to cut off) IIC bus: peak drive limit B7...B4 minimum value (range -8) maximum value (range +7)			1.5 3.5		V V	
Soft clipper						
Starting level (relative to peak detek- tors level) IIC bus: peak drive limit B3, B2 10 11 00 01 (soft clipper off)			100 105 110 infinite		% % %	



## Recommended operating conditions

Parameter	Symbol	Min	Nom	Max	Unit	Remark
Slope IIC bus: peak drive limit B1,B0						
10			0.125			
11			0.375			
00			0.625			
01			0.875			

**Blue stretch** (control bit BLUES; subaddress 20h)

Decrease of small signal gain for red and green at nominal input amplitudes and nominal settings of contrast and brightness			17		%	
Percentage of nominal input voltage at which decrease of gain begins (nominal settings of contrast and brightness)			80		%	

**I<sup>2</sup>C Bus** (all values are referred to min(V<sub>IH</sub>) and max(V<sub>IL</sub>))

SCL clock frequency	f <sub>SCL</sub>	0		400	kHz	
High-level input voltage	V <sub>IH</sub>	0.75* V <sub>DD(D)</sub>		5.25	V	
Low-level input voltage	V <sub>IL</sub>	0		1.5	V	
Load capacitance	C <sub>b</sub>			400	pF	
Rise times of SCL, SDA	t <sub>R</sub>	20+0.1* C <sub>b</sub> /pF*)		300*)	ns	
Fall times of SCL, SDA	t <sub>F</sub>	20+0.1* C <sub>b</sub> /pF*)		300	ns	
Set-up time DATA	t <sub>SU;DAT</sub>	100			ns	
Hold time DATA	t <sub>HD;DAT</sub>	0			ns	
Spike duration at inputs	C <sub>b</sub>		0	50	ns	

\*) Fast-mode (f<sub>SCL</sub> = 400 kHz)

## Characteristics (assuming recommended operating conditions)

## 9 Characteristics (assuming recommended operating conditions)

Parameter	Symbol	Min	Nom	Max	Unit	Remark
Average supply current of $V_{DD(D)} + V_{DD(A1..4)}$			245	290	mA	DEL1...0 = 11 (maximum delay)
Average supply current of $V_{DD(MC)}$			32	40	mA	
Total power dissipation				1.28	W	
Standby supply current of $V_{DD(D)} + V_{DD(A1..4)}$			15	25	mA	no standby mode for $V_{DD(MC)}$
<b>TTL Inputs CLKI, VSYNC, RESN, TEST, FH1_2, CLEXT, SSD</b>						
Input leakage current	$ I_{leak} $			10	$\mu$ A	
<b>Input X1</b>						
Input leakage current	$ I_{leak} $			50	$\mu$ A	
<b>Input HSYNC</b>						
Input leakage current	$ I_{leak} $			100	$\mu$ A	
<b>Analog Inputs HPROT, VPROT, HSAFE, BSOIN, IBEAM, FBL1, FBL2</b>						
Input leakage current	$ I_{leak} $			10	$\mu$ A	
<b>Analog Inputs Y/R0, U/G0, V/B0, R/Y1, G/U1, B/V1, R2, G2, B2, DCI</b>						
Input leakage current	$ I_{leak} $			100	nA	
<b>I<sup>2</sup>C Input/Output SDA</b>						
SDA output Low level	$V_{OL}$			0.6	V	$I_O = 6$ mA
<b>I<sup>2</sup>C Inputs SDA/SCL</b>						
Hysteresis of Schmitt trigger inputs	$V_{hys}$	0.2			V	1)
Input leakage current	$ I_{leak} $			10	$\mu$ A	
<b>Output Pins SWITCH, VBLO</b>						
Output Low level	$V_{OL}$			0.4	V	$I_O = 1$ mA
Output High level	$V_{OH}$	2.4			V	$I_O = -1$ mA
<b>Output PROTON</b>						
Output Low level (if HPON=0 and VPON=0)	$V_{OL}$			0.4	V	$I_O = 1$ mA
Output High level (if HPON=1 or VPON=1)	$V_{OH}$	2.4			V	$I_O = -1$ mA

## Characteristics (assuming recommended operating conditions)

Parameter	Symbol	Min	Nom	Max	Unit	Remark
<b>Output PWM</b>						
Output Low level	$V_{OL}$			0.4	V	$I_O = 1 \text{ mA}$
Output High level	$V_{OH}$	2.4			V	$I_O = -1 \text{ mA}$
Period	$T_{PWM}$		$T_H$			$T_H = \text{hor. period}$
Resolution	$t_R$		$T_H/108$			PWMS0=0 (subaddress 1A)
			$T_H/864$			PWMS0=1
<b>Output SCP</b>						
Output Low level	$V_{OL}$	0		1	V	$I_O = 1 \text{ mA}$
Output BLanking level	$V_{OHBL}$	$V_{DD(MC)}/2$ -0.6V	$V_{DD(MC)}/2$	$V_{DD(MC)}/2$ +0.3V		$ I_O  = 100 \mu\text{A}$
Output High level	$V_{OH}$	$V_{DD(MC)}$ -1.3V		$V_{DD(MC)}$		$I_O = -1 \text{ mA}$
<b>DAC Output D/A</b>						
DAC Resolution			8		bit	
DAC Output LOW			0.20		V	
DAC Output HIGH			2.98		V	
Load Capacitance				30	pF	
Output Load		20			kOhm	
Offset Error		-3%		3%		
Gain Error		-3%		3%		
INL		-2		2	LSB	
DNL		-1		1	LSB	
<b>DAC Output E/W</b>						
DAC resolution			10		bit	linear range: 100...900
DAC output LOW			0.64		V	input data = 100
DAC output HIGH			2.48		V	input data = 900
Load capacitance				30	pF	
Output load		20			kOhm	
Zero error		-2%		2%		DAC output voltage = 1.6V,*)

## Characteristics (assuming recommended operating conditions)

Parameter	Symbol	Min	Nom	Max	Unit	Remark
Gain error		-5%		5%		*)
INL		-0.2%		0.2%		*)
DNL		-0.1%		0.1%		*)

\*) input range = 100...900

**DAC Output VD+, VD-**

DAC resolution			14		bit	linear range: 1500...15000
DAC output LOW (VD-)			0.62		V	input data = 1500
DAC output HIGH (VD-)			2.6		V	input data = 15000
DAC output LOW (VD-) - (VD+)			-1.90		V	input data = 1500
DAC output HIGH (VD-) - (VD+)			1,96		V	input data = 15000
Load capacitance				30	pF	
Output load		20			kOhm	
Zero error		-1%		1%		(VD-)-(VD+)=0V, *)
Gain error		-5%		5%		*)
INL		-0.5%		0.5%		*)
DNL		monotonous				guaranteed by design

\*) input range = 1500...15000

**Reference Output VREFH**

Output voltage		1.568	1.6	1.632	V	tolerance +-2%
----------------	--	-------	-----	-------	---	----------------

**Open Drain Output HD**

Output Low level	$V_{OL}$	0		1	V	$I_O = 8 \text{ mA}$
Maximum Voltage	$V_{OH}$			5.5	V	

**Output H35K**

Output Low level	$V_{OL}$			0.4	V	$I_O = 1 \text{ mA}$
Output High level	$V_{OH}$	2.4			V	$I_O = -1 \text{ mA}$
Positive-going threshold of $f_{HSYNC}$	$f_{TH1}$		33.9		kHz	see 11.1
Negative-going threshold of $f_{HSYNC}$	$f_{TH2}$		33.3		kHz	see 11.1
Hysteresis	$f_{TH1} - f_{TH2}$		0.6		kHz	

## Characteristics (assuming recommended operating conditions)

Parameter	Symbol	Min	Nom	Max	Unit	Remark
Delay from positive-going threshold of $f_{HSYNC}$ to output	$t_{D1}$					$(14 - \text{int}(27/12 * f_{H0}[\text{kHz}] - 64)) * T_V$
Delay from negative-going threshold of $f_{HSYNC}$ to output	$t_{D2}$		100		ns	see 11.1

**Output H38K**

Output Low level	$V_{OL}$			0.4	V	$I_O = 1 \text{ mA}$
Output High level	$V_{OH}$	2.4			V	$I_O = -1 \text{ mA}$
Positive-going threshold of $f_{HSYNC}$	$f_{TH3}$		36.9		kHz	see 11.1
Negative-going threshold of $f_{HSYNC}$	$f_{TH4}$		36.4		kHz	see 11.1
Hysteresis	$f_{TH3} - f_{TH4}$		0.5		kHz	
Delay from positive-going threshold of $f_{HSYNC}$ to output	$t_{D3}$					$(21 - \text{int}(27/12 * f_{H0}[\text{kHz}] - 64)) * T_V$
Delay from negative-going threshold of $f_{HSYNC}$ to output	$t_{D4}$		100		ns	see 11.1

**RGB Output**

Differential output resistance	$R_O$		25	30	$\Omega$	
Maximum output current	$I_O$	4	5		mA	
Minimum output voltage	$V_{O-min}$			0.8	V	
Maximum output voltage	$V_{O-max}$	$V_{DD(MC)} - 1.3$	7		V	
Output signal amplitude (peak-to-peak value)	$V_{O(p-p)}$		2.1		V	at nominal luminance input signal, nominal contrast and white-point control
Maximum output signal amplitude (peak-to-peak value)	$V_{O(p-p)max}$	3.3			V	
Nominal black level voltage			2.5		V	at nominal brightness = +30
Control range of the black current stabilisation			+1		V	
Blanking level			-0.4		V	difference with nominal black level at nominal contrast and white point
Leakage measurement level			-0.05		V	
Cut off measurement level			0.25		V	
White point measurement level			0.36		V	

## Characteristics (assuming recommended operating conditions)

Parameter	Symbol	Min	Nom	Max	Unit	Remark
Variation of black level with temperature <sup>1)</sup>			1		mV/K	
Gain range of white point control loop			+6		dB	
Relative variation in black level between all inputs during variation of: Supply voltage (+-10%) <sup>1)</sup> Saturation (50 dB) <sup>1)</sup>				20 20	mV mV	nominal controls nom. contrast and white point
Contrast (20 dB) <sup>1)</sup>				20	mV	nom. saturation and white point
Brightness (+-0.5V) <sup>1)</sup> Temperature (range 40 °C) <sup>1)</sup>				20 20	mV mV	nominal controls nominal controls
Signal-to-noise ratio of the output signal <sup>1)</sup>	S/N	60			dB	$V_{0(p-p)}/RMS_{noise}$ bandwidth 10 MHz
Bandwidth of the output signals for all inputs: Delay off (DELOFF = 1): Maximum delay (DELOFF = 0, DEL1 = 1, DEL0 = 1):	B	30 20			MHz MHz	at -3 dB

## Scan velocity modulation output SVM (Y output)

Output signal amplitude (peak-to-peak value)	$V_{SVM(p-p)}$		1.9		V	SVMOFF = 0
Maximum output current	$I_{o-svm}$	4	5		mA	
Output signal at black level	$V_{SVM-black}$		0.6		V	
Differential output resistance	$R_{o-svm}$		25	30	$\Omega$	
Bandwidth of the output signal for all inputs	$B_{SVM}$	30			MHz	at -3 dB
Total delay from SVM output to RGB outputs DEL 1, DEL0: 00 01 10 11	$D_{svm0}$		25 35 45 55		ns ns ns ns	DELOFF = 0
Total delay from SVM output to RGB outputs	$D_{svm1}$		15		ns	DELOFF = 1 (basic delay)

<sup>1)</sup>not tested during production but characterization in pre-production

## 10 Application information

### 10.1 System overview Dig. TV 100Hz

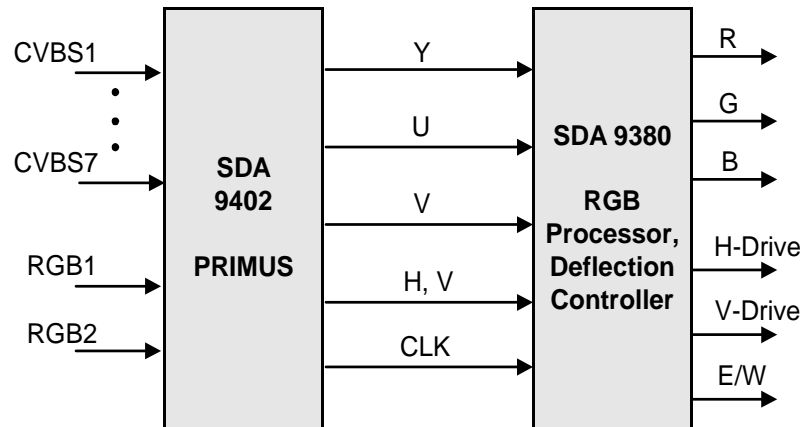

### 10.2 System overview Multisync Deflection

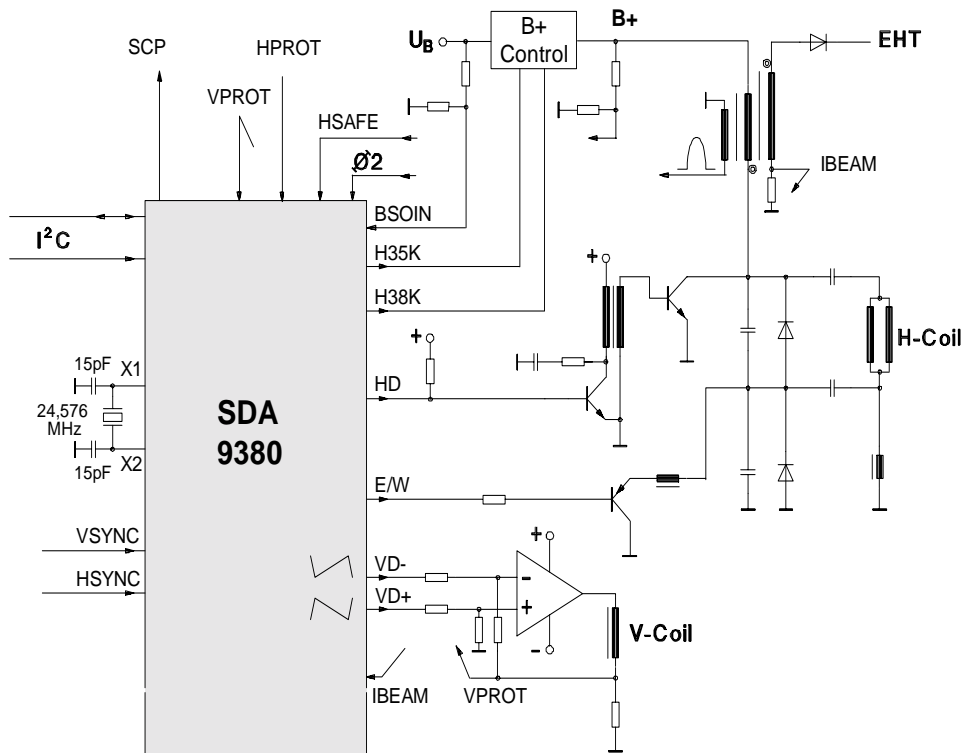

10.3 Application circuit diagram

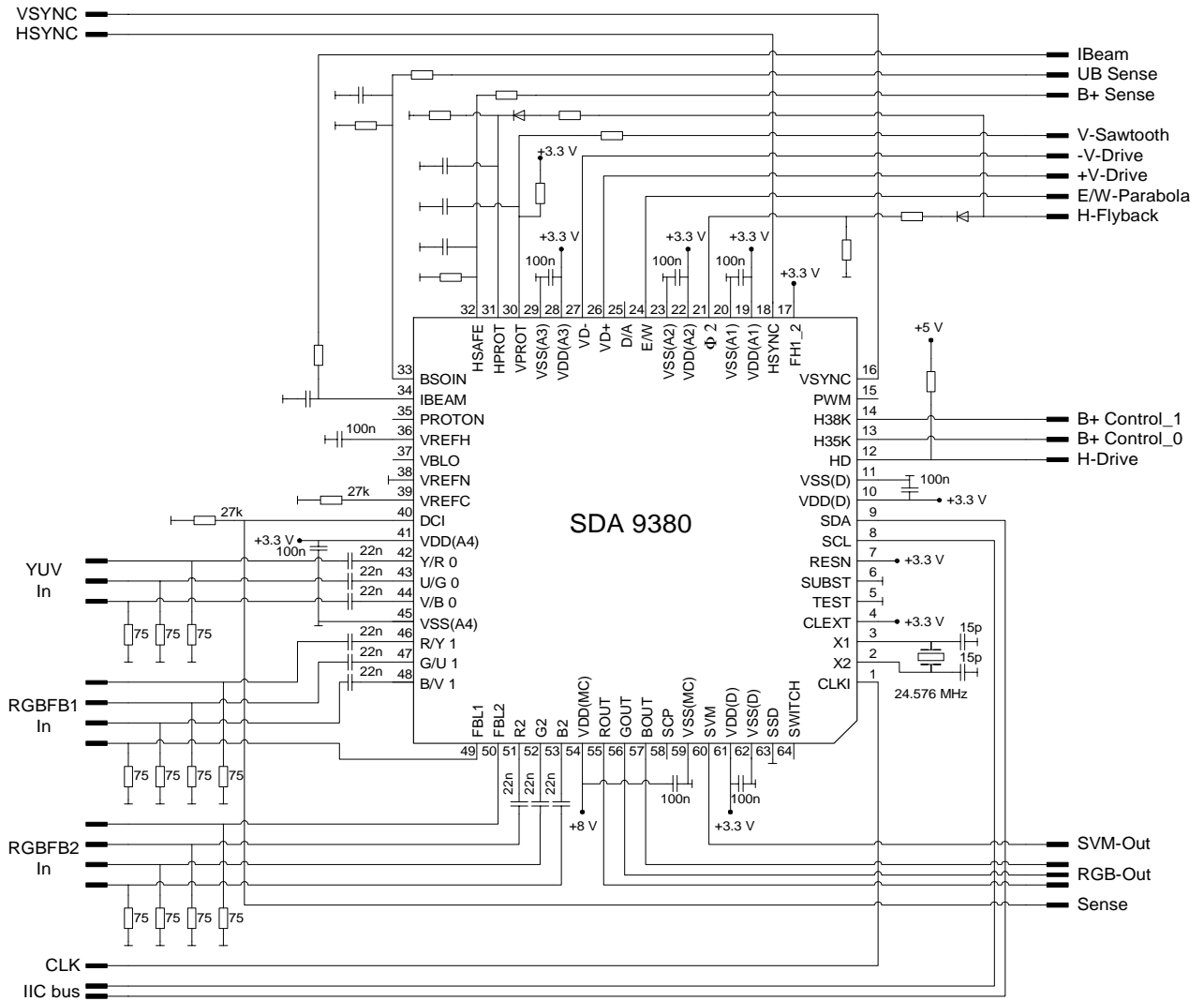



## 11 Waveforms

### 11.1 Timing diagram of H35K and H38K

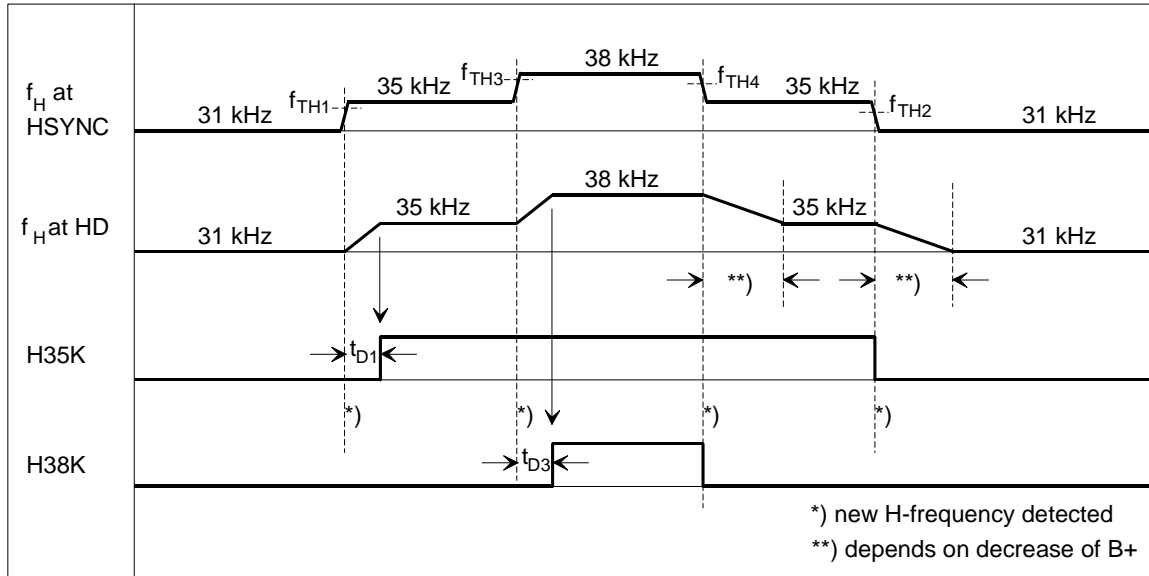

### 11.2 Black Switch-Off diagrams

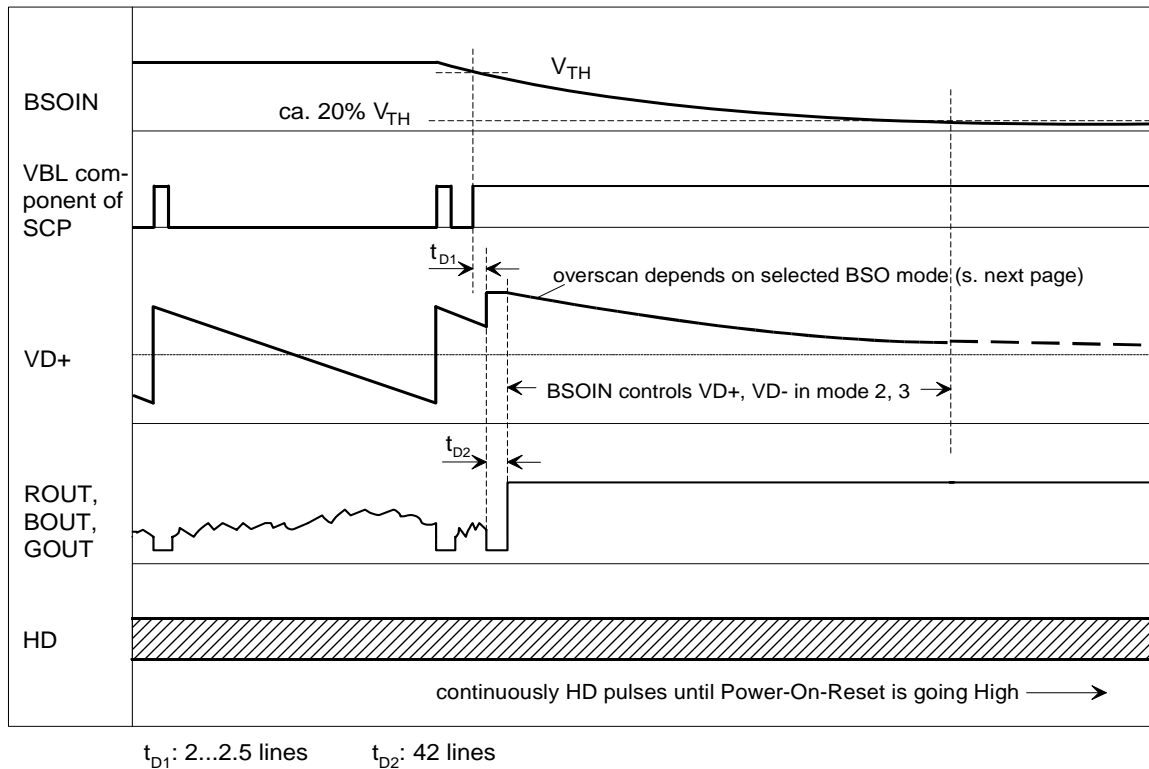

Mode 1 (constant overscan, BSO = 01):

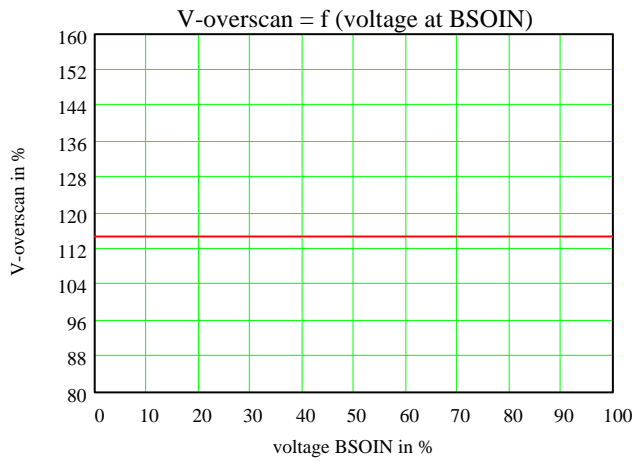

V-overscan in %:

f(100) = 115

f(75) = 115

f(50) = 115

f(25) = 115

Mode 2 (parabolic function, BSO = 10):

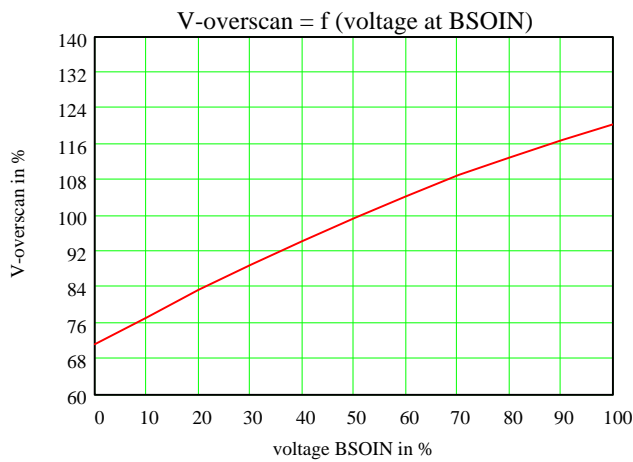

V-overscan in %:

f(100) = 120.7

f(75) = 111.1

f(50) = 99.6

f(25) = 86

Mode 3 (linear function, BSO = 11):

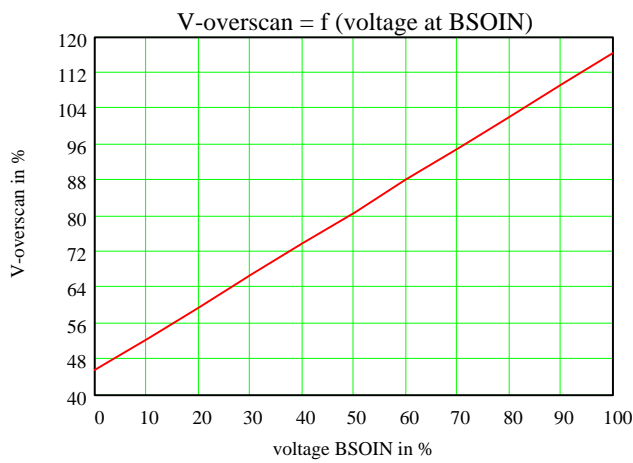

V-overscan in %:

f(100) = 116.5

f(75) = 98.8

f(50) = 81

f(25) = 63

11.3 Power On/Off diagram

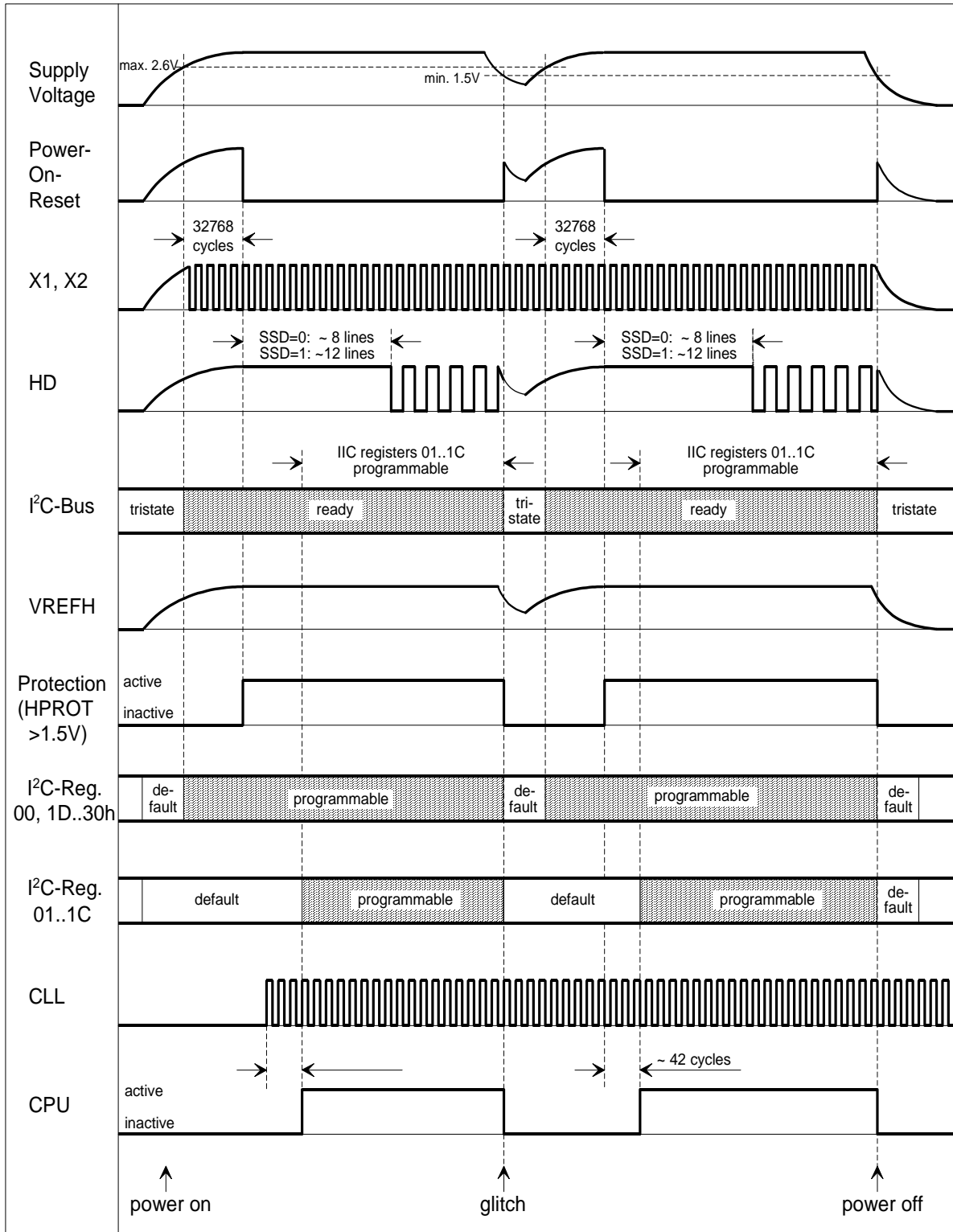



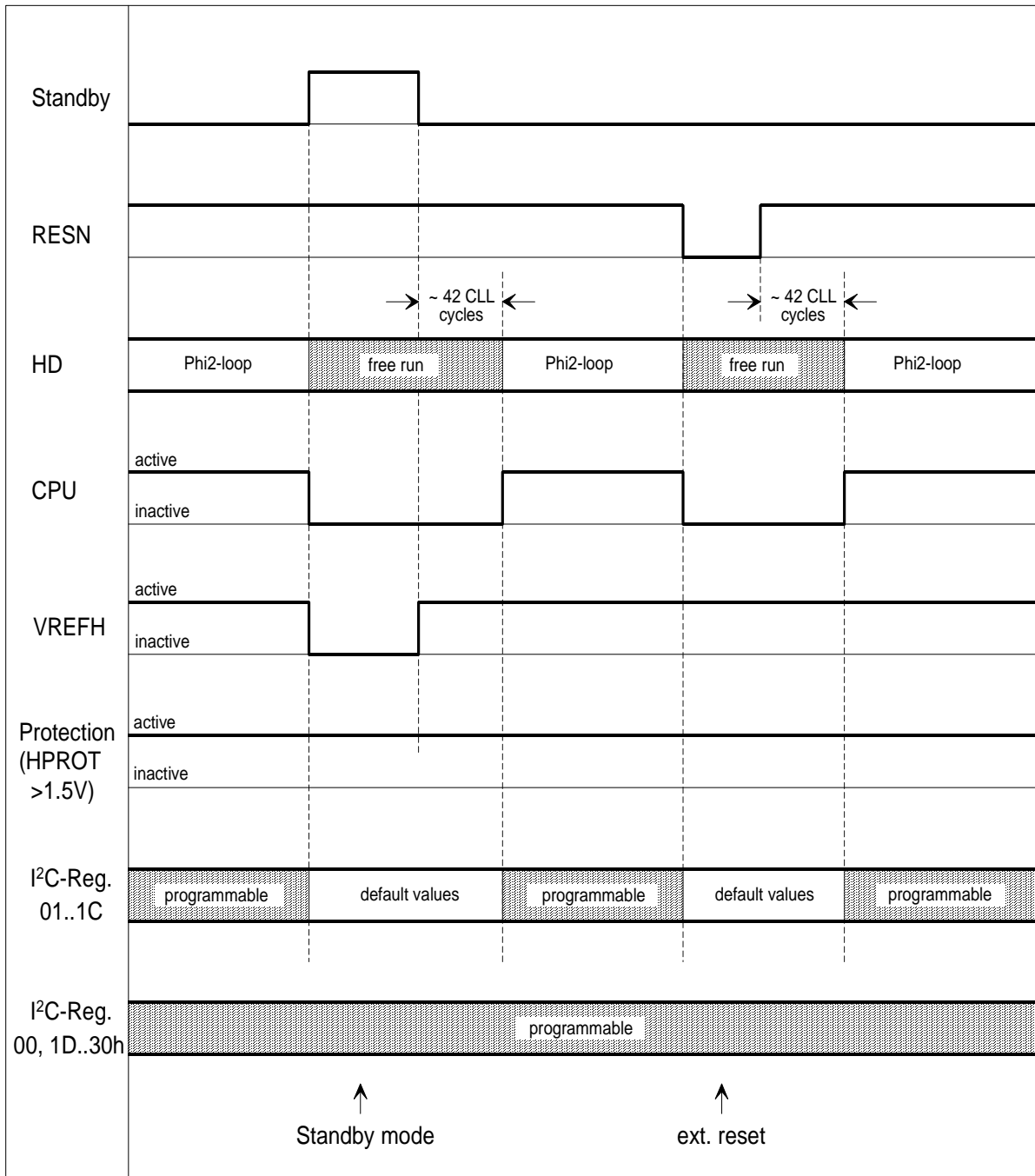

11.4 Standby mode, RESN diagram

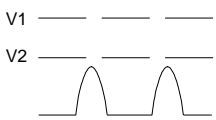

Waveforms

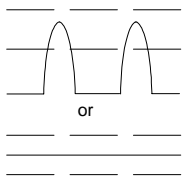
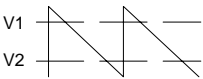
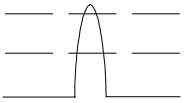
11.5 Function of H,V protection

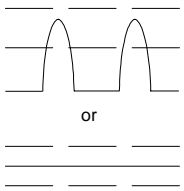
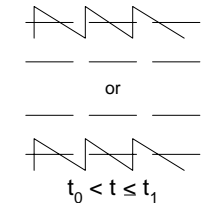
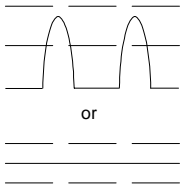
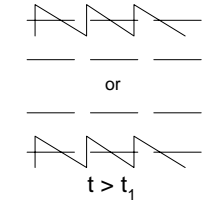
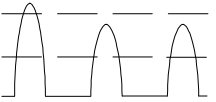
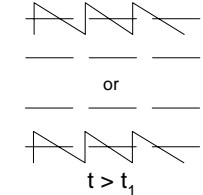
	HPROT	VPROT	Mode	SCP	HPON <sup>b)</sup> (IIC-Bus)	VPON <sup>b)</sup> (IIC-Bus)
1			start up	continuous blanking	0	0
2			H, V in operation	a)	0	0
3			EHT over-voltage	continuous blanking after t <sub>2</sub>	1 after t <sub>2</sub>	0
4			H in operation V short failure	continuous blanking after t <sub>0</sub> if SSC = 0	0	0
5			V longer failure → H off after t <sub>1</sub>	continuous blanking after t <sub>0</sub> if SSC = 0	0	1 after t <sub>1</sub>
6			EHT short over-voltage	continuous blanking after t <sub>2</sub>	1 after t <sub>2</sub>	1 after t <sub>1</sub>

$t_0 = 2/f_v \dots 3/f_v$      $t_1 = 64/f_v \dots 128/f_v$      $t_2 = 1/f_v \dots 2/f_v$

a) depends on IIC control items

b) HPON = 1 or VPON = 1: HD = 1(off)

11.6 Black Stretch diagram

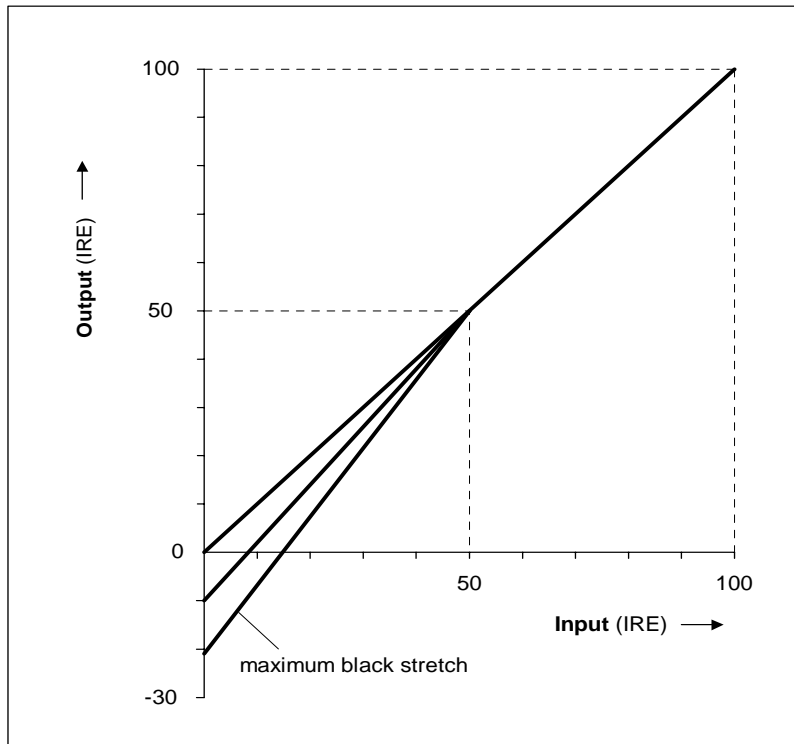

11.7 Soft Clipping diagram

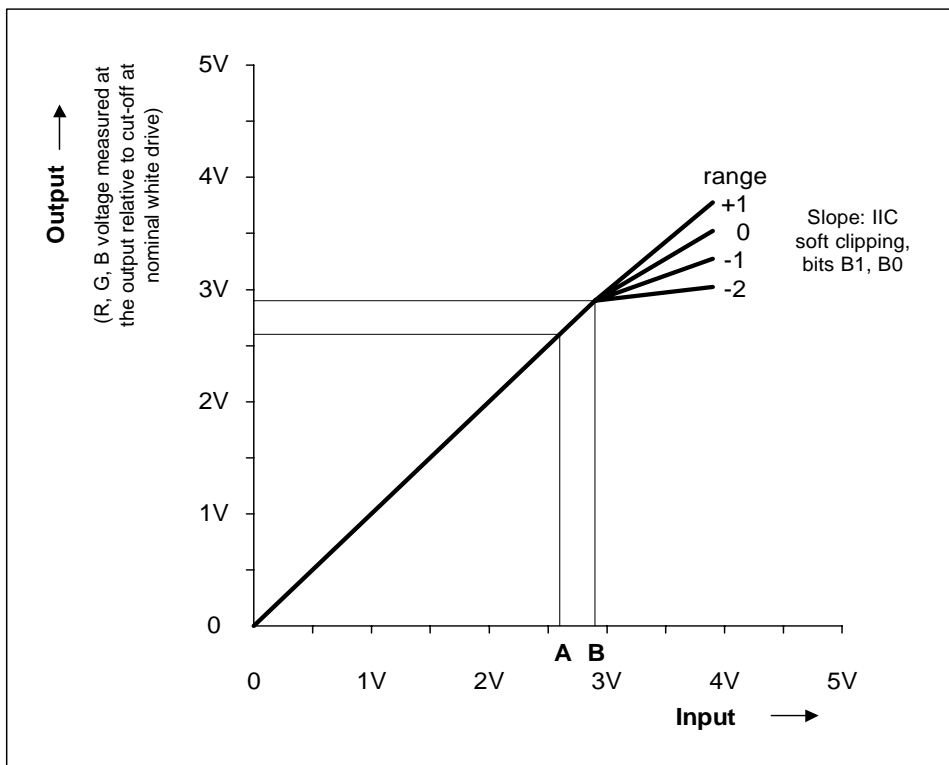

12 Package outlines

P-MQFP-64

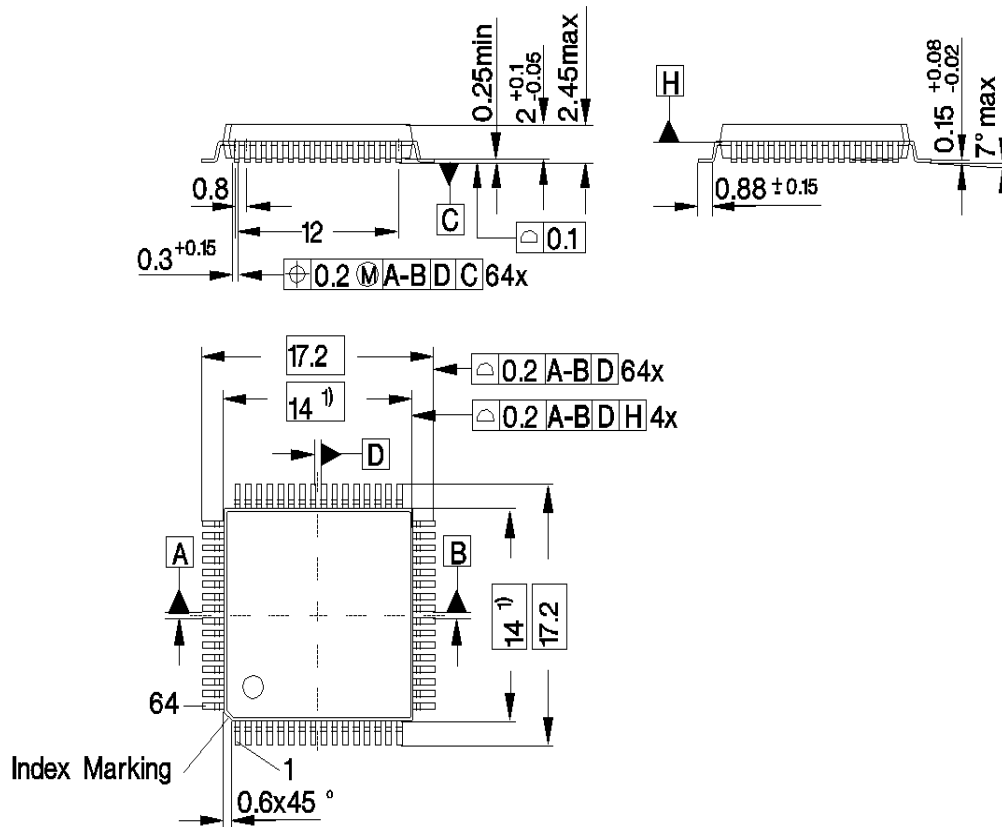

1) Does not include plastic or metal protrusion of 0.25 max. per side

Micronas GmbH  
Hans-Bunte-Strasse 19  
D-79108 Freiburg (Germany)  
P.O. Box 840  
D-79008 Freiburg (Germany)  
Tel. +49-761-517-0  
Fax +49-761-517-2174  
E-mail: [docservice@micronas.com](mailto:docservice@micronas.com)  
Internet: [www.micronas.com](http://www.micronas.com)

Printed in Germany  
Order No. 6251-549-1PD

All information and data contained in this data sheet are without any commitment, are not to be considered as an offer for conclusion of a contract, nor shall they be construed as to create any liability. Any new issue of this data sheet invalidates previous issues. Product availability and delivery are exclusively subject to our respective order confirmation form; the same applies to orders based on development samples delivered. By this publication, Micronas GmbH does not assume responsibility for patent infringements or other rights of third parties which may result from its use.

Further, Micronas GmbH reserves the right to revise this publication and to make changes to its content, at any time, without obligation to notify any person or entity of such revisions or changes.

No part of this publication may be reproduced, photocopied, stored on a retrieval system, or transmitted without the express written consent of Micronas GmbH.