

IR-Lumineszenzdiode (850 nm) mit hoher Ausgangsleistung
High Power Infrared Emitter (850 nm)
Lead (Pb) Free Product - RoHS Compliant
SFH 4236



Wesentliche Merkmale

- max. Gleichstrom 1 A
- niedriger Wärmewiderstand (9 K/W)
- Schwerpunktwellenlänge 850 nm
- ESD-sicher bis 2 kV nach JESD22-A114-E
- Erweiterte Korrosionsfestigkeit (s.a. Abschnitt Maßzeichnung)

Anwendungen

- Infrarotbeleuchtung für Kameras
- Überwachungssysteme
- Fahrer-Assistenz Systeme
- Beleuchtung für Bilderkennungssysteme

Sicherheitshinweise

Je nach Betriebsart emittieren diese Bauteile hochkonzentrierte, nicht sichtbare Infrarot-Strahlung, die gefährlich für das menschliche Auge sein kann. Produkte, die diese Bauteile enthalten, müssen gemäß den Sicherheitsrichtlinien der IEC-Normen 60825-1 und 62471 behandelt werden.

Features

- max. DC-current 1 A
- Low thermal resistance (9 K/W)
- Center of spectral emission at 850 nm
- ESD safe up to 2 kV acc. to JESD22-A114-E
- Superior Corrosion Robustness (see chapter package outlines)

Applications

- Infrared Illumination for cameras
- Surveillance systems
- Driver assistance systems
- Machine vision systems

Safety Advices

Depending on the mode of operation, these devices emit highly concentrated non visible infrared light which can be hazardous to the human eye. Products which incorporate these devices have to follow the safety precautions given in IEC 60825-1 and IEC 62471.

Typ Type	Bestellnummer Ordering Code	Strahlstärkegruppierung ¹⁾ ($I_F = 1 \text{ A}$, $t_p = 10 \text{ ms}$) Radiant Intensity Grouping ¹⁾ I_e (mW/sr)
SFH 4236	Q65110A9564	> 250 (typ. 630)

¹⁾ gemessen bei einem Raumwinkel $\Omega = 0.01 \text{ sr}$ / measured at a solid angle of $\Omega = 0.01 \text{ sr}$

Grenzwerte ($T_A = 25\text{ °C}$)**Maximum Ratings**

Bezeichnung Parameter	Symbol Symbol	Wert Value	Einheit Unit
Betriebs- und Lagertemperatur Operating and storage temperature range	T_{op}, T_{stg}	- 40 ... + 125	°C
Sperrschichttemperatur Junction temperature	T_J	+ 145	°C
Sperrspannung Reverse voltage	V_R	1	V
Vorwärtsgleichstrom Forward current	I_F	1	A
Stoßstrom, $t_p < 200\ \mu\text{s}$, $D = 0$ Surge current	I_{FSM}	5	A
Leistungsaufnahme Power consumption	P_{tot}	1.8	W
Wärmewiderstand Sperrschicht - Lötstelle Thermal resistance junction - soldering point	R_{thJS}	9	K/W

Kennwerte ($T_A = 25\text{ °C}$)**Characteristics**

Bezeichnung Parameter	Symbol Symbol	Wert Value	Einheit Unit
Wellenlänge der Strahlung Wavelength at peak emission $I_F = 1\text{ A}$, $t_p = 10\text{ ms}$	λ_{peak}	860	nm
Centroid-Wellenlänge der Strahlung Centroid wavelength $I_F = 1\text{ A}$, $t_p = 10\text{ ms}$	$\lambda_{centroid}$	850	nm
Spektrale Bandbreite bei 50% von I_{max} Spectral bandwidth at 50% of I_{max} $I_F = 1\text{ A}$, $t_p = 10\text{ ms}$	$\Delta\lambda$	30	nm
Abstrahlwinkel Half angle	φ	± 20	Grad deg.
Aktive Chipfläche Active chip area	A	1	mm ²
Abmessungen der aktiven Chipfläche Dimension of the active chip area	$L \times B$ $L \times W$	1×1	mm ²

Kennwerte ($T_A = 25\text{ °C}$)

Characteristics (cont'd)

Bezeichnung Parameter	Symbol Symbol	Wert Value	Einheit Unit
Schaltzeiten, I_e von 10% auf 90% und von 90% auf 10%, $I_F = 5\text{ A}$, $R_L = 50\ \Omega$ Switching times, I_e from 10% to 90% and from 90% to 10%, $I_F = 5\text{ A}$, $R_L = 50\ \Omega$	t_r / t_f	7 / 14	ns
Durchlassspannung Forward voltage $I_F = 1\text{ A}$, $t_p = 100\ \mu\text{s}$ $I_F = 5\text{ A}$, $t_p = 100\ \mu\text{s}$	V_F V_F	1.5 (< 1.8) 2.0 (< 2.9)	V V
Gesamtstrahlungsfluss Total radiant flux $I_F = 1\text{ A}$, $t_p = 100\ \mu\text{s}$	Φ_e	530	mW
Temperaturkoeffizient von I_e bzw. Φ_e Temperature coefficient of I_e or Φ_e $I_F = 1\text{ A}$, $t_p = 10\text{ ms}$	TC_I	- 0.3	%/K
Temperaturkoeffizient von V_F Temperature coefficient of V_F $I_F = 1\text{ A}$, $t_p = 10\text{ ms}$	TC_V	- 1	mV/K
Temperaturkoeffizient von λ Temperature coefficient of λ $I_F = 1\text{ A}$, $t_p = 10\text{ ms}$	$TC_{\lambda, \text{centroid}}$	+ 0.3	nm/K

Strahlstärke I_e in Achsrichtung¹⁾gemessen bei einem Raumwinkel $\Omega = 0.01$ sr**Radiant Intensity I_e in Axial Direction**at a solid angle of $\Omega = 0.01$ sr

Bezeichnung Parameter	Symbol	Werte Values				Einheit Unit
		-CW	-DA	-DB	-EW	
Strahlstärke	$I_{e \text{ min}}$	250	400	500	630	mW/sr
Radiant intensity	$I_{e \text{ max}}$	500	630	800	1250	mW/sr
$I_F = 1$ A, $t_p = 10$ ms						

¹⁾ Nur eine Gruppe in einer Verpackungseinheit/
Only one group in one packing unit

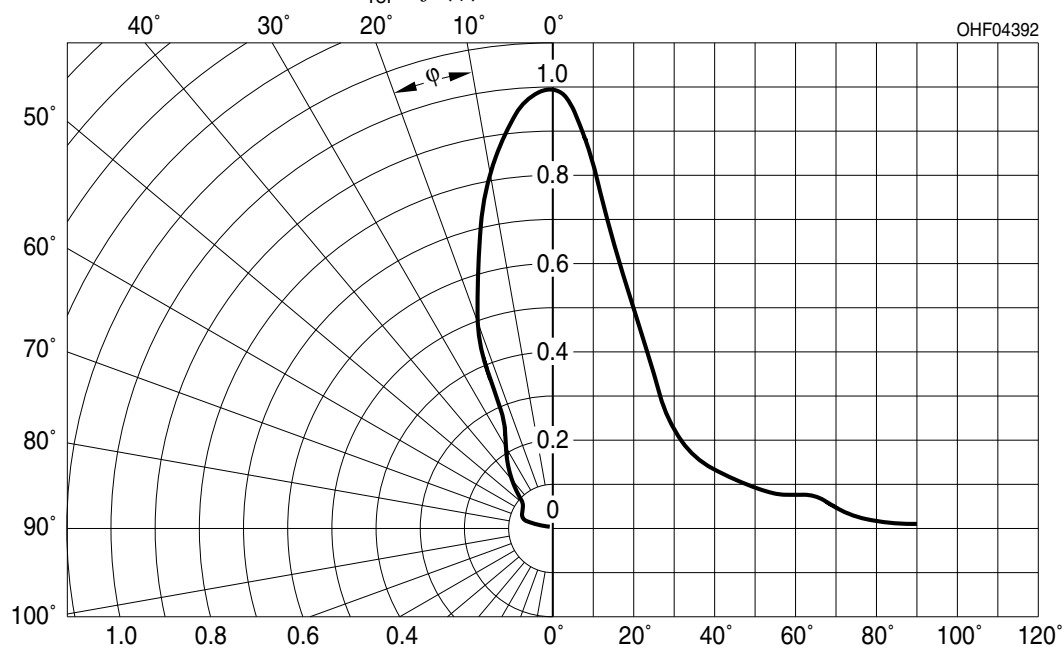
Abstrahlcharakteristik**Radiation Characteristics $I_{\text{rel}} = f(\varphi)$** 

**Relative spektrale Emission
Relative Spectral Emission**

$I_{rel} = f(\lambda)$

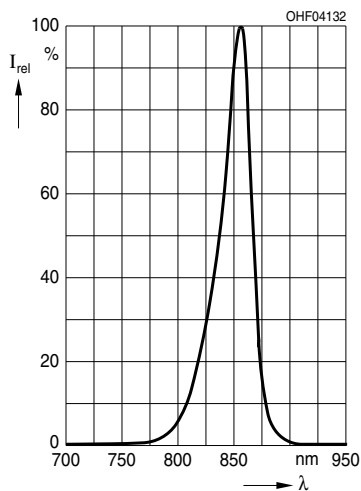

**Durchlassstrom
Forward Current**

$I_F = f(V_F)$

Single pulse, $t_p = 100 \mu s$

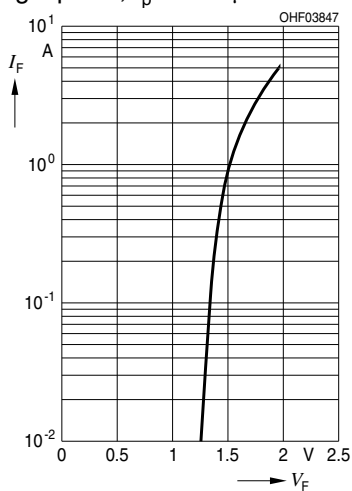

**Relativer Gesamtstrahlungsfluss
Relative Total Radiant Flux**

$\Phi_e / \Phi_e(1000mA) = f(I_F)$

Single pulse, $t_p = 100 \mu s$

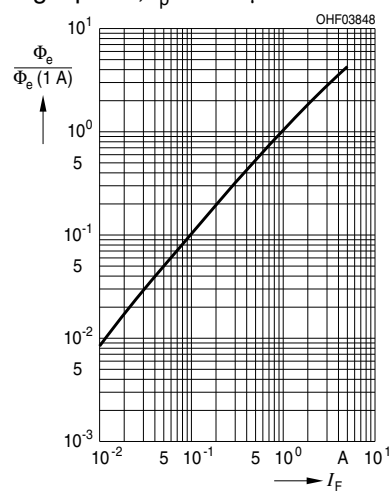

**Max. zulässiger Durchlassstrom
Max. Permissible Forward Current**

$I_F = f(T_A), R_{thJS} = 9 \text{ K/W}$

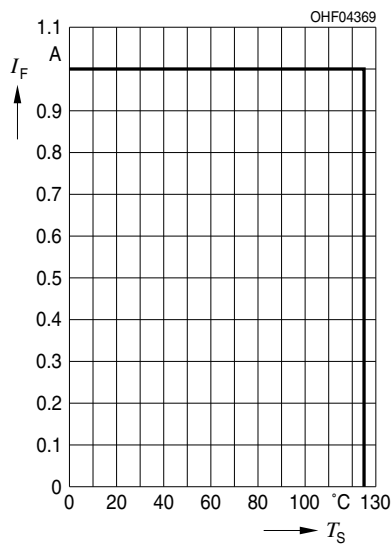

**Zulässige Impulsbelastbarkeit
Permissible Pulse Handling**

Capability $I_F = f(t_p), T_S = 85 \text{ °C}$,
Duty cycle $D = \text{parameter}$

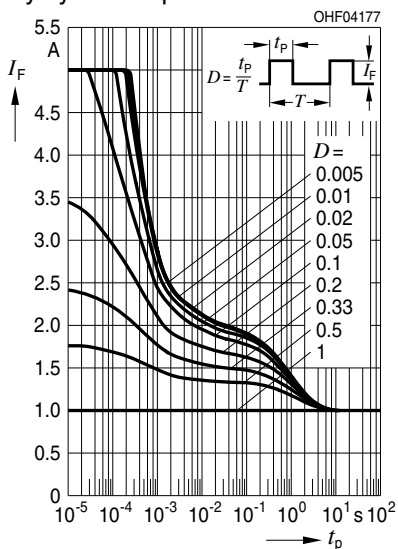

Maßzeichnung Package Outlines

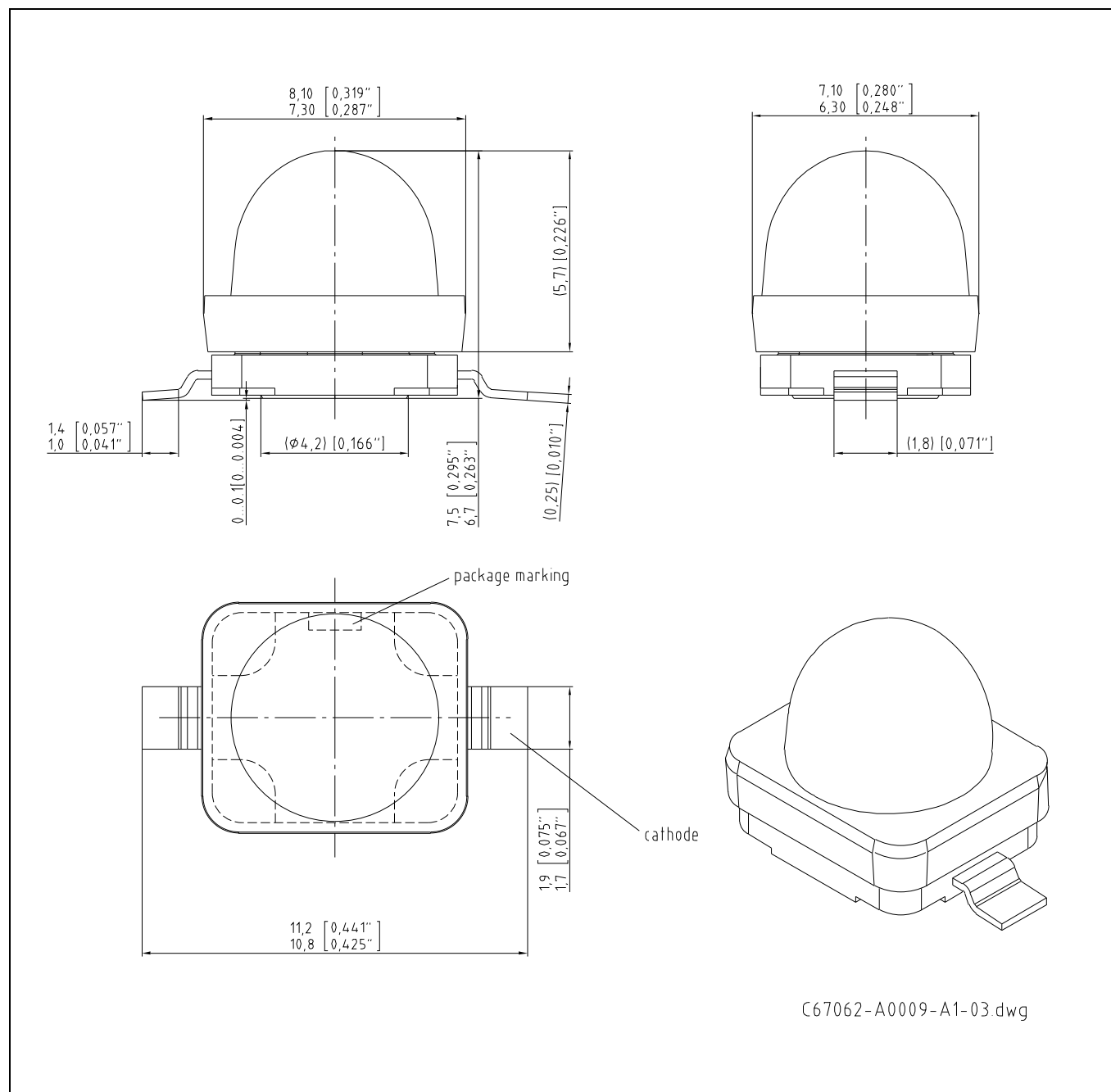

Maße in mm (inch) / Dimensions in mm (inch).

Korrosionsfestigkeit besser als EN 60068-2-60 (method 4):
mit erweitertem Korrosionstest: 40°C / 90%rh / 15ppm H₂S / 336h

Corrosion robustness better than EN 60068-2-60 (method 4):
with enhanced corrosion test: 40°C / 90%rh / 15ppm H₂S / 336h

Empfohlenes Lötpaddesign
Recommended Solder Pad Design

Achtung:

Anode und Heatsink sind elektrisch verbunden

Attention:

Anode and Heatsink are electrically connected

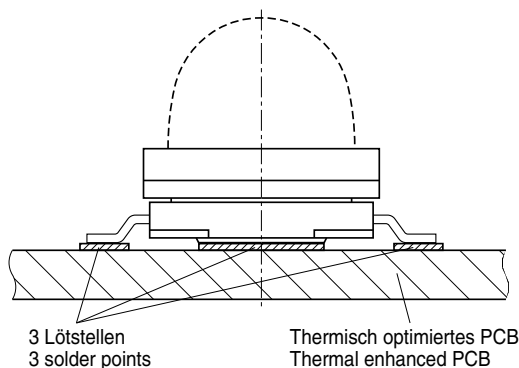



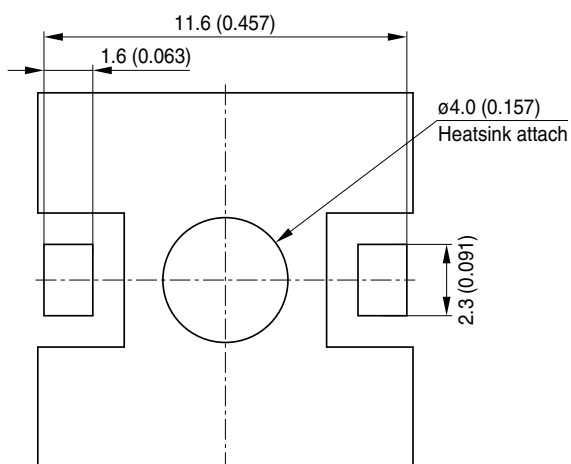

Footprint

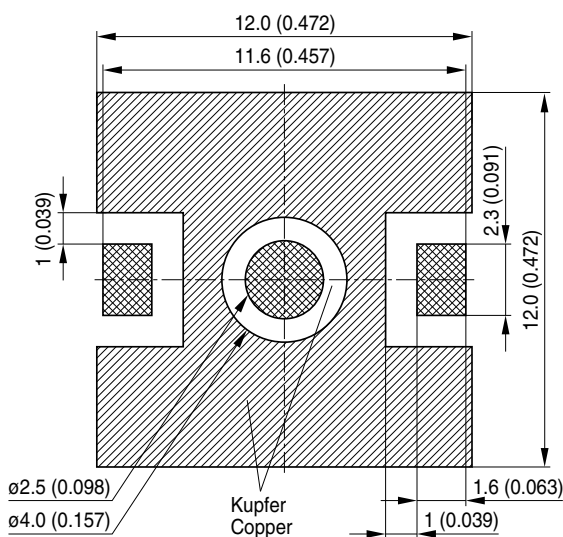

Empfohlene Padgeometrie

Recommended Solder Pad Design



-  Lötstopplack
Solder resist
-  Lötpasten Schablone
Solder paste stencil
-  Freies Kupfer
Bare Copper

OHPY3638

Maße in mm (inch) / Dimensions in mm (inch).

Lötbedingungen Soldering Conditions

Reflow Lötprofil für bleifreies Löten
Reflow Soldering Profile for lead free soldering

Vorbehandlung nach JEDEC Level 2
Preconditioning acc. to JEDEC Level 2
(nach J-STD-020C)
(acc. to J-STD-020C)

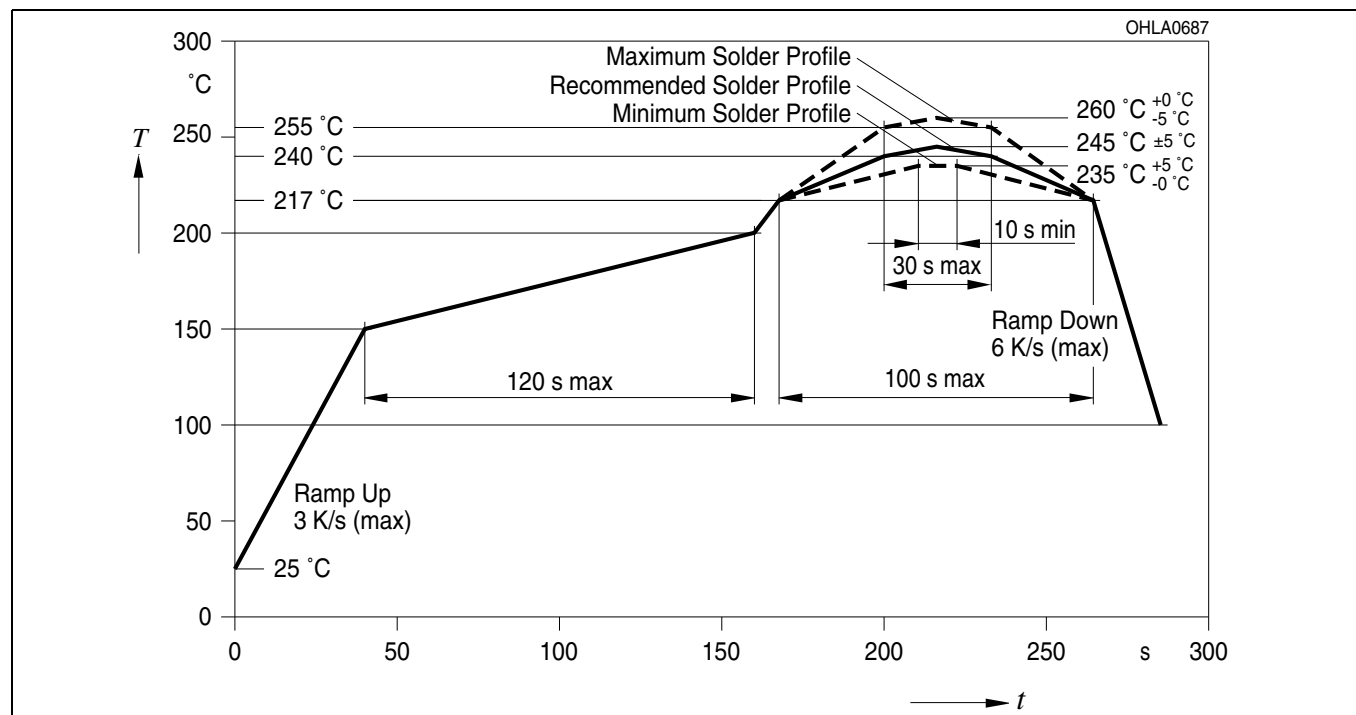

Anm.: Das Gehäuse ist für Ultraschallreinigung nicht geeignet

Note: Package not suitable for ultra sonic cleaning

Published by
OSRAM Opto Semiconductors GmbH
Leibnizstraße 4, D-93055 Regensburg
www.osram-os.com

© All Rights Reserved.

The information describes the type of component and shall not be considered as assured characteristics. Terms of delivery and rights to change design reserved. Due to technical requirements components may contain dangerous substances. For information on the types in question please contact our Sales Organization.

Packing

Please use the recycling operators known to you. We can also help you – get in touch with your nearest sales office. By agreement we will take packing material back, if it is sorted. You must bear the costs of transport. For packing material that is returned to us unsorted or which we are not obliged to accept, we shall have to invoice you for any costs incurred.

Components used in life-support devices or systems must be expressly authorized for such purpose! Critical components¹, may only be used in life-support devices or systems² with the express written approval of OSRAM OS.

¹ A critical component is a component used in a life-support device or system whose failure can reasonably be expected to cause the failure of that life-support device or system, or to affect its safety or effectiveness of that device or system.

² Life support devices or systems are intended (a) to be implanted in the human body, or (b) to support and/or maintain and sustain human life. If they fail, it is reasonable to assume that the health of the user may be endangered.

EU RoHS and China RoHS compliant product



此产品符合欧盟 RoHS 指令的要求；

按照中国的相关法规和标准，不含有毒有害物质或元素。

Mouser Electronics

Related Product Links

[720-SFH4236 - Osram Opto Semiconductor SFH 4236](#)