

# Optocoupler, Phototransistor Output, With Base Connection

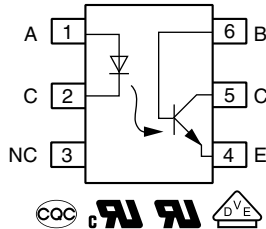

23030



## FEATURES

- Isolation test voltage, 5000 V<sub>RMS</sub>
- Low coupling capacitance
- High common mode transient immunity
- Storage temperature, -55 ° to +150 °C
- Material categorization:  
for definitions of compliance please see [www.vishay.com/doc?99912](http://www.vishay.com/doc?99912)



**RoHS**  
COMPLIANT  
HALOGEN  
**FREE**  
**GREEN**  
(5-2008)

## APPLICATIONS

- Telecom
- Industrial controls
- Battery powered equipment
- Office machines
- Programmable controllers

## AGENCY APPROVALS

- [UL](#)
- [cUL](#)
- [DIN EN 60747-5-5 \(VDE 0884-5\) available with option 1](#)
- [CQC](#)

## DESIGN SUPPORT TOOLS AVAILABLE



## DESCRIPTION

The SFH601 has a GaAs infrared emitting diode emitter, which is optically coupled to a silicon planar phototransistor detector, and is incorporated in a plastic DIP-6 package.

It features a high current transfer ratio, low coupling capacitance, and high isolation voltage.

The coupling device is designed for signal transmission between two electrically separated circuits.

| ORDERING INFORMATION     |   |                 |                  |                   |                   |   |            |                |   |   |                  |   |
|--------------------------|---|-----------------|------------------|-------------------|-------------------|---|------------|----------------|---|---|------------------|---|
| S                        | F | H               | 6                | 0                 | 1                 | - | #          | X              | 0 | # | #                | # |
| PART NUMBER              |   |                 |                  |                   |                   |   | CTR<br>BIN | PACKAGE OPTION |   |   | TAPE AND<br>REEL |   |
| AGENCY CERTIFIED/PACKAGE |   | CTR (%)         |                  |                   |                   |   |            |                |   |   |                  |   |
| <b>UL, cUL, CQC</b>      |   | <b>40 to 80</b> | <b>63 to 125</b> | <b>100 to 200</b> | <b>160 to 320</b> |   |            |                |   |   |                  |   |
| DIP-6                    |   | SFH601-1        | SFH601-2         | SFH601-3          | -                 |   |            |                |   |   |                  |   |
| SMD-6, option 7          |   |                 |                  | SFH601-3X007T     | SFH601-4X007T     |   |            |                |   |   |                  |   |
| SMD-6, option 9          |   | -               | -                | SFH601-3X009      | -                 |   |            |                |   |   |                  |   |
| <b>VDE, UL, cUL, CQC</b> |   | <b>40 to 80</b> | <b>63 to 125</b> | <b>100 to 200</b> | <b>160 to 320</b> |   |            |                |   |   |                  |   |
| DIP-6, 400 mil, option 6 |   | -               | SFH601-2X016     | SFH601-3X016      | -                 |   |            |                |   |   |                  |   |
| SMD-6, option 7          |   | -               | -                | SFH601-3X017T     | -                 |   |            |                |   |   |                  |   |

### Note

- Additional options may be possible, please contact sales office

| <b>ABSOLUTE MAXIMUM RATINGS</b> ( $T_{amb} = 25\text{ }^{\circ}\text{C}$ , unless otherwise specified) |                   |            |             |                    |
|--|-------------------|------------|-------------|--------------------|
| PARAMETER  | TEST CONDITION    | SYMBOL     | VALUE       | UNIT               |
| <b>INPUT</b>   |                   |            |             |                    |
| Reverse voltage  |                   | $V_R$      | 6           | V                  |
| Forward current  |                   | $I_F$      | 60          | mA                 |
| Total power dissipation  |                   | $P_{diss}$ | 100         | mW                 |
| <b>OUTPUT</b>  |                   |            |             |                    |
| Collector emitter voltage  |                   | $V_{CEO}$  | 100         | V                  |
| Emitter base voltage   |                   | $V_{EBO}$  | 7           | V                  |
| Collector current  |                   | $I_C$      | 50          | mA                 |
| Power dissipation  |                   | $P_{diss}$ | 150         | mW                 |
| <b>COUPLER</b>   |                   |            |             |                    |
| Storage temperature range  |                   | $T_{stg}$  | -55 to +150 | $^{\circ}\text{C}$ |
| Ambient temperature range  |                   | $T_{amb}$  | -55 to +100 | $^{\circ}\text{C}$ |
| Soldering temperature  | $t = 10\text{ s}$ | $T_{sld}$  | 260         | $^{\circ}\text{C}$ |

**Note**

- Stresses in excess of the absolute maximum ratings can cause permanent damage to the device. Functional operation of the device is not implied at these or any other conditions in excess of those given in the operational sections of this document. Exposure to absolute maximum ratings for extended periods of the time can adversely affect reliability

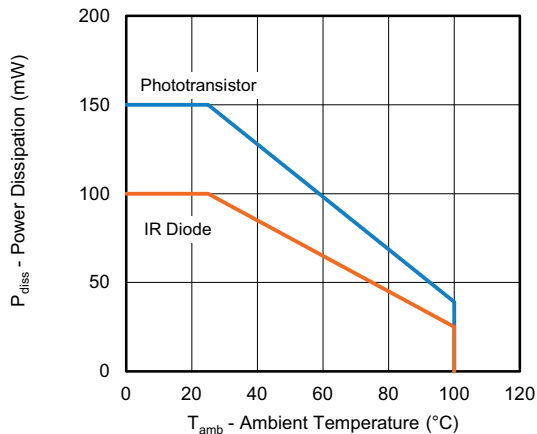

Fig. 1 - Power Dissipation vs. Ambient Temperature

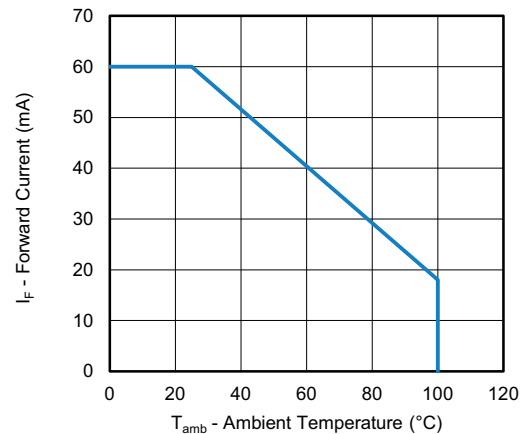

Fig. 2 - Maximum Forward Current vs. Ambient Temperature

| <b>ELECTRICAL CHARACTERISTICS</b> ( $T_{amb} = 25\text{ }^{\circ}\text{C}$ , unless otherwise specified) |  |             |      |       |      |               |
|--|--|-------------|------|-------|------|---------------|
| PARAMETER  | TEST CONDITION                               | SYMBOL      | MIN. | TYP.  | MAX. | UNIT          |
| <b>INPUT</b>   |  |             |      |       |      |               |
| Forward voltage  | $I_F = 60\text{ mA}$                         | $V_F$       | -    | 1.45  | 1.65 | V             |
| Breakdown voltage  | $I_R = 10\text{ }\mu\text{A}$                | $V_{BR}$    | 6    | -     | -    | V             |
| Reverse current  | $V_R = 6\text{ V}$                           | $I_R$       | -    | 0.01  | 10   | $\mu\text{A}$ |
| Capacitance  | $V_F = 0\text{ V}$ , $f = 1\text{ kHz}$      | $C_I$       | -    | -     | 100  | pF            |
| <b>OUTPUT</b>  |  |             |      |       |      |               |
| Collector emitter leakage current  | $V_{CE} = 10\text{ V}$                       | $I_{CEO}$   | -    | 2     | 50   | nA            |
| <b>COUPLER</b>   |  |             |      |       |      |               |
| Collector emitter saturation voltage   | $I_F = 10\text{ mA}$ , $I_C = 2.5\text{ mA}$ | $V_{CEsat}$ | -    | 0.125 | 0.4  | V             |
| Coupling capacitance   | $V_{I-O} = 0$ , $f = 1\text{ MHz}$           | $C_{IO}$    | -    | 0.6   | -    | pF            |

**Note**

- Minimum and maximum values are testing requirements. Typical values are characteristics of the device and are the result of engineering evaluation. Typical values are for information only and are not part of the testing requirements

| CURRENT TRANSFER RATIO |   |          |        |      |      |      |      |
|------------------------|---|----------|--------|------|------|------|------|
| PARAMETER              | TEST CONDITION                              | PART     | SYMBOL | MIN. | TYP. | MAX. | UNIT |
| $I_C/I_F$              | $I_F = 10 \text{ mA}, V_{CE} = 5 \text{ V}$ | SFH601-1 | CTR    | 40   | -    | 80   | %    |
|                        |   | SFH601-2 | CTR    | 63   | -    | 125  | %    |
|                        |   | SFH601-3 | CTR    | 100  | -    | 200  | %    |
|                        |   | SFH601-4 | CTR    | 160  | -    | 320  | %    |

| SWITCHING CHARACTERISTICS |  |           |      |      |      |               |  |
|---------------------------|--|-----------|------|------|------|---------------|--|
| PARAMETER                 | TEST CONDITION   | SYMBOL    | MIN. | TYP. | MAX. | UNIT          |  |
| Turn-on time              | $V_{CC} = 5 \text{ V}, I_C = 2 \text{ mA}, R_L = 100 \Omega$ | $t_{on}$  | -    | 3    | -    | $\mu\text{s}$ |  |
| Turn-off time             | $V_{CC} = 5 \text{ V}, I_C = 2 \text{ mA}, R_L = 100 \Omega$ | $t_{off}$ | -    | 3    | -    | $\mu\text{s}$ |  |

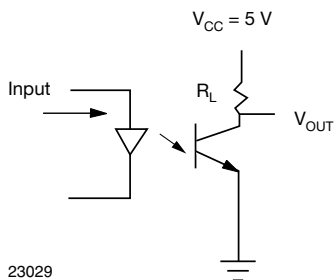

Fig. 3 - Test Circuit for Switching Characteristics

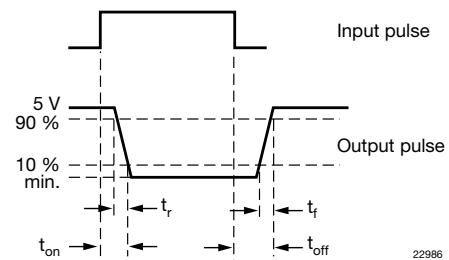

Fig. 4 - Parameter and Limit Definition

| SAFETY AND INSULATION RATINGS                |  |            |                |                  |
|--|--|------------|----------------|------------------|
| PARAMETER                                    | TEST CONDITION   | SYMBOL     | VALUE          | UNIT             |
| Climatic classification                      | According to IEC 68 part 1                                     |            | 55 / 115 / 21  |                  |
| Pollution degree                             | According to DIN VDE 0109                                      |            | 2              |                  |
| Comparative tracking index                   | Insulation group IIIa  | CTI        | 175            |                  |
| Maximum rated withstanding isolation voltage | According to UL1577, $t = 1 \text{ min}$                       | $V_{ISO}$  | 5000           | $V_{RMS}$        |
| Maximum transient isolation voltage          | According to DIN EN 60747-5-5                                  | $V_{IOTM}$ | 8000           | $V_{peak}$       |
| Maximum repetitive peak isolation voltage    | According to DIN EN 60747-5-5                                  | $V_{IORM}$ | 890            | $V_{peak}$       |
| Isolation resistance                         | $T_{amb} = 25 \text{ }^\circ\text{C}, V_{IO} = 500 \text{ V}$  | $R_{IO}$   | $\geq 10^{12}$ | $\Omega$         |
|  | $T_{amb} = 100 \text{ }^\circ\text{C}, V_{IO} = 500 \text{ V}$ | $R_{IO}$   | $\geq 10^{11}$ | $\Omega$         |
| Output safety power                          |  | $P_{SO}$   | 700            | mW               |
| Input safety current                         |  | $I_{SI}$   | 400            | mA               |
| Input safety temperature                     |  | $T_{SI}$   | 175            | $^\circ\text{C}$ |
| Creepage distance                            | DIP-6, SMD-6   |            | $\geq 7$       | mm               |
| Clearance distance                           |  |            | $\geq 7$       | mm               |
| Creepage distance                            | DIP-6, 400 mil   |            | $\geq 8$       | mm               |
| Clearance distance                           |  |            | $\geq 8$       | mm               |
| Insulation thickness                         |  | DTI        | $\geq 0.4$     | mm               |

**Note**

- As per IEC 60747-5-5, § 7.4.3.8.2, this optocoupler is suitable for “safe electrical insulation” only within the safety ratings. Compliance with the safety ratings shall be ensured by means of protective circuits

**TYPICAL CHARACTERISTICS** ( $T_{amb} = 25\text{ }^{\circ}\text{C}$ , unless otherwise specified)

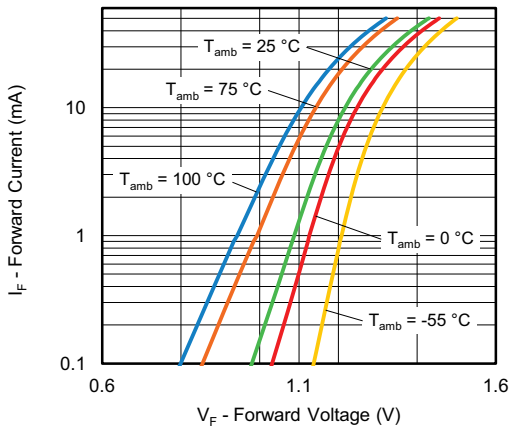

Fig. 5 - Forward Current vs. Forward Voltage

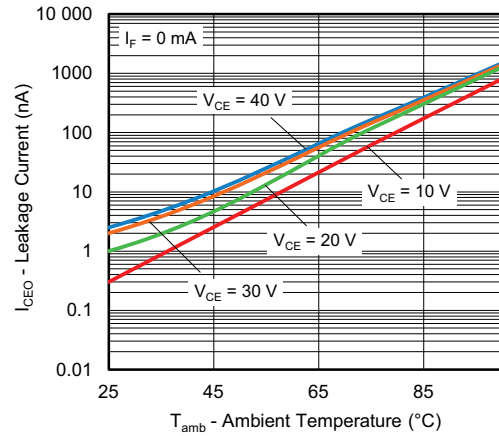

Fig. 8 - Leakage Current vs. Ambient Temperature

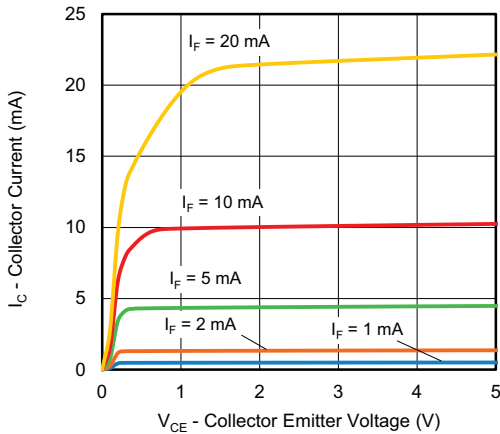

Fig. 6 - Collector Current vs. Collector Emitter Voltage (non-saturated)

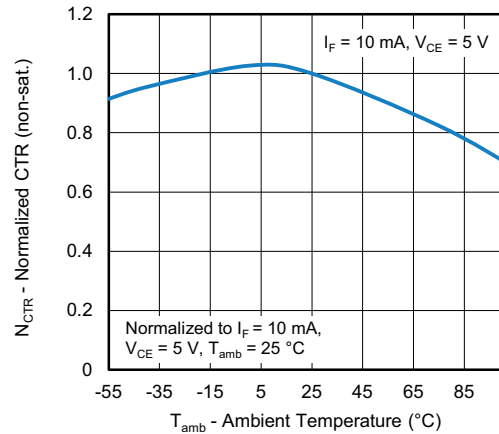

Fig. 9 - Normalized CTR vs. Ambient Temperature (non-saturated)

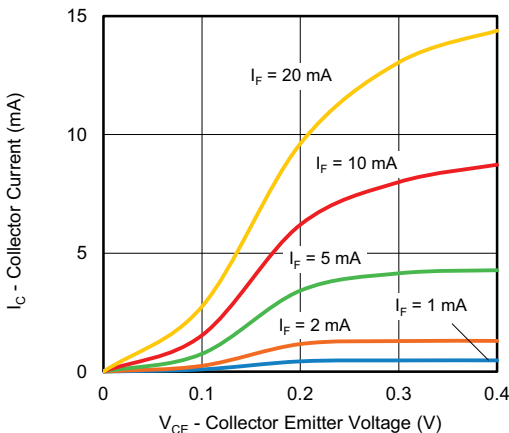

Fig. 7 - Collector Current vs. Collector Emitter Voltage (saturated)

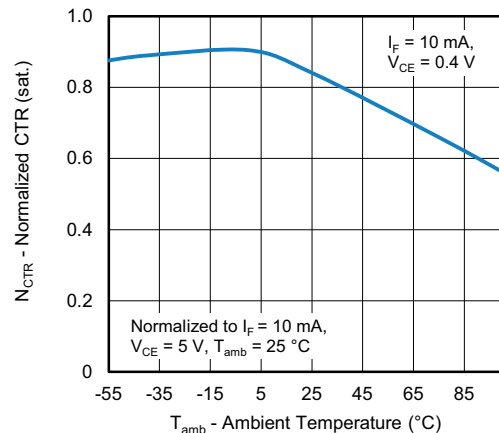

Fig. 10 - Normalized CTR vs. Ambient Temperature (saturated)

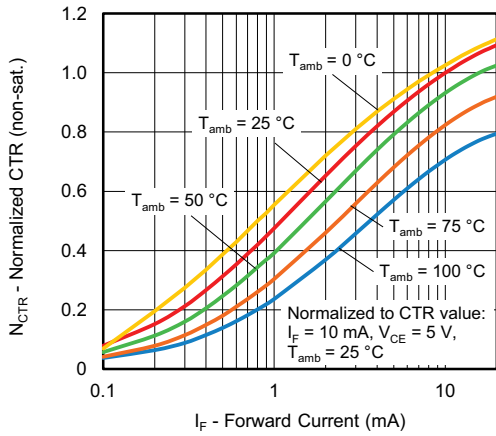

Fig. 11 - Normalized CTR vs. Forward Current (non-saturated)

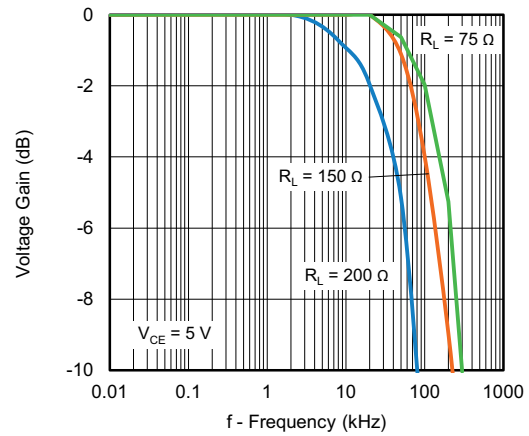

Fig. 13 - Voltage Gain vs. Frequency

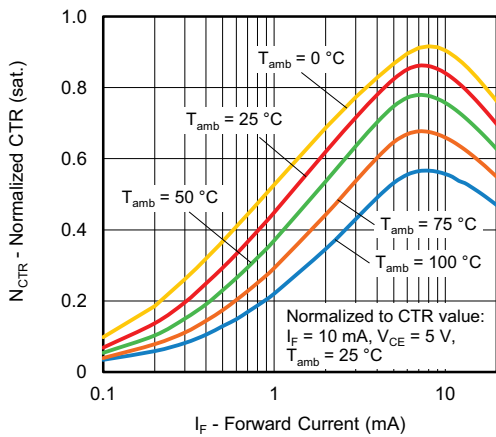

Fig. 12 - Normalized CTR vs. Forward Current (saturated)

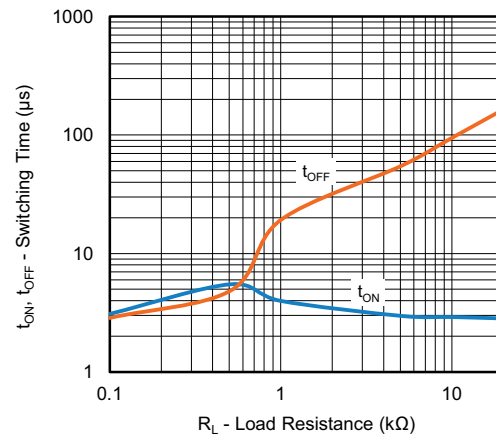
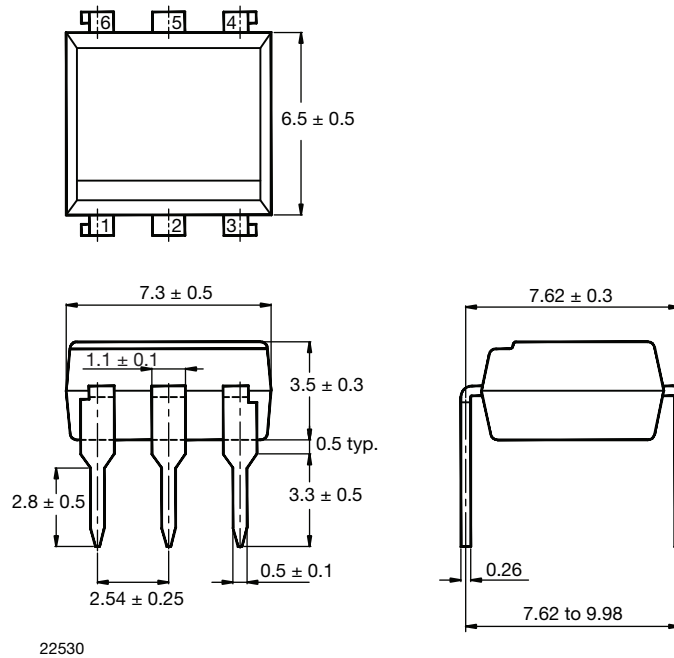

Fig. 14 - Switching Time vs. Load Resistance

**PACKAGE DIMENSIONS** in millimeters

**6 Pin Package**



22530

**Option 6**

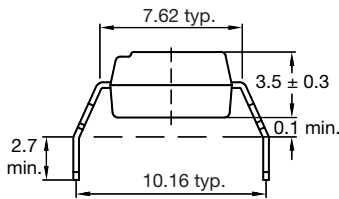

20802-52

**Option 7**

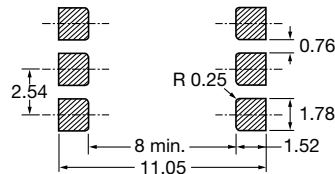
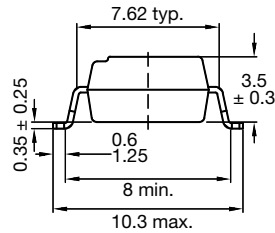

**Option 9**

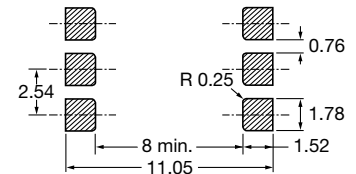
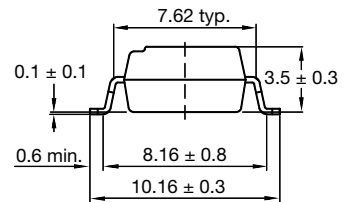

**PACKAGE MARKING**

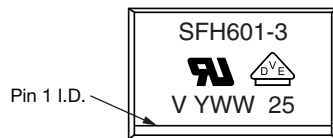

Fig. 15 - Example of SFH601

**Notes**

- “YWW” is the date code marking (Y = year code, WW = week code)
- VDE logo is only marked on VDE option parts
- Tape and reel suffix (T) is not part of the package marking

**PACKAGING INFORMATION** (in millimeters)

| DEVICES PER TUBE |            |           |           |
|------------------|------------|-----------|-----------|
| TYPE             | UNITS/TUBE | TUBES/BOX | UNITS/BOX |
| DIP-6            | 50         | 40        | 2000      |
| DIP-6, option 6  | 50         | 40        | 2000      |
| SMD-6, option 9  | 50         | 40        | 2000      |

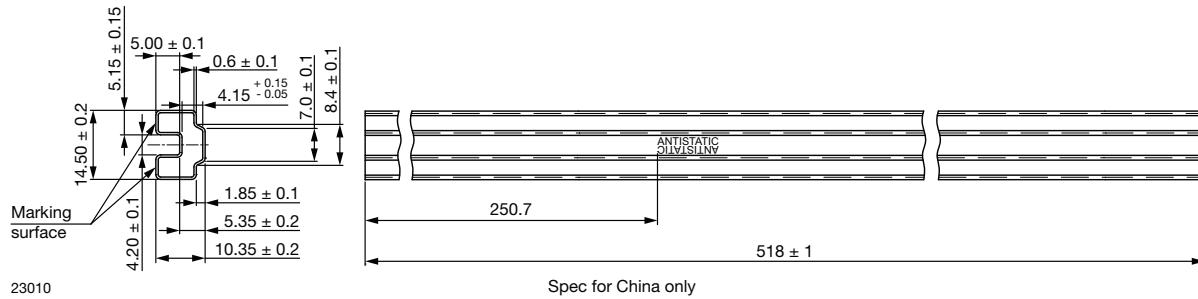
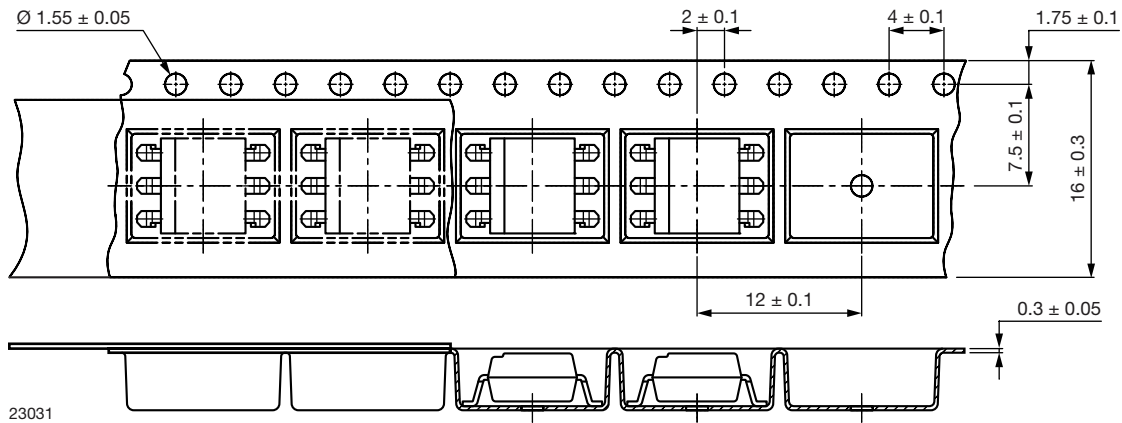
**DIP-6**

**SMD-6**

Reel

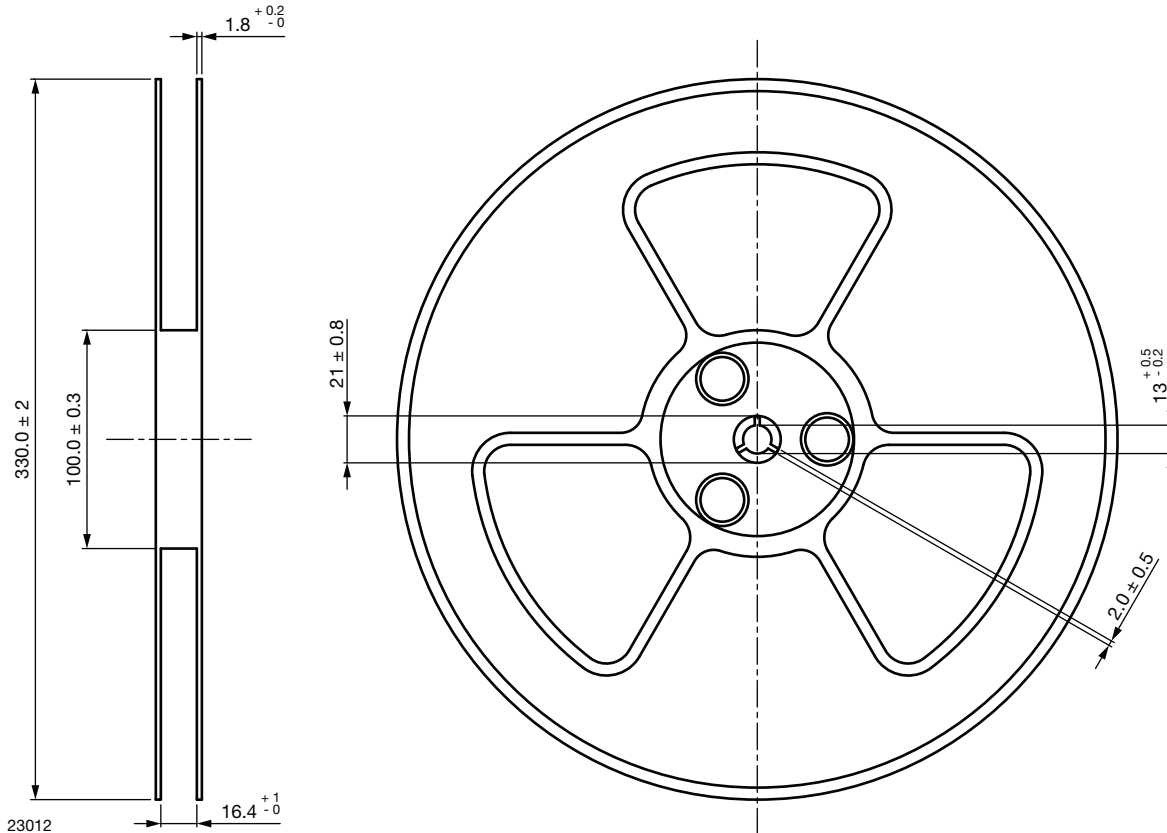

Fig. 18 - Tape and Reel Shipping Medium

**SOLDER PROFILES**

**IR Reflow Soldering (JEDEC® J-STD-020C compliant)**

One time soldering reflow is recommended within the condition of temperature and time profile shown below. Do not solder more than three times.

| PROFILE ITEM                                   | CONDITIONS       |
|--|------------------|
| Preheat  |                  |
| - Temperature minimum ( $T_{S \text{ min.}}$ ) | 150 °C           |
| - Temperature maximum ( $T_{S \text{ max.}}$ ) | 200 °C           |
| - Time (min. to max.) ( $t_s$ )                | 90 s ± 30 s      |
| Soldering zone                                 |                  |
| - Temperature ( $T_L$ )                        | 217 °C           |
| - Time ( $t_L$ )                               | 60 s             |
| Peak temperature ( $T_p$ )                     | 260 °C           |
| Ramp-up rate                                   | 3 °C/s max.      |
| Ramp-down rate                                 | 3 °C/s to 6 °C/s |

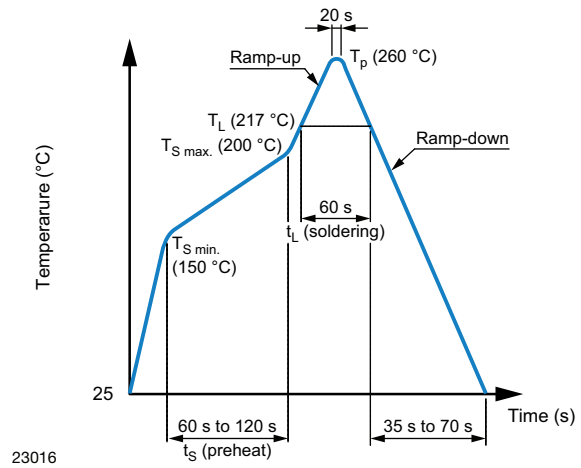

Fig. 19





**Wave Soldering (JEDEC JESD22-A111 compliant)**

One time soldering is recommended within the condition of temperature.

Temperature: 260 °C + 0 °C / - 5 °C

Time: 10 s

Preheat temperature: 25 °C to 140 °C

Preheat time: 30 s to 80 s

**Hand Soldering by Soldering Iron**

Allow single lead soldering in every single process. One time soldering is recommended.

Temperature: 380 °C + 0 °C / - 5 °C

Time: 3 s max.



Fig. 20

23017



# DIP-6A

## PACKAGE DIMENSIONS in inches (millimeters)

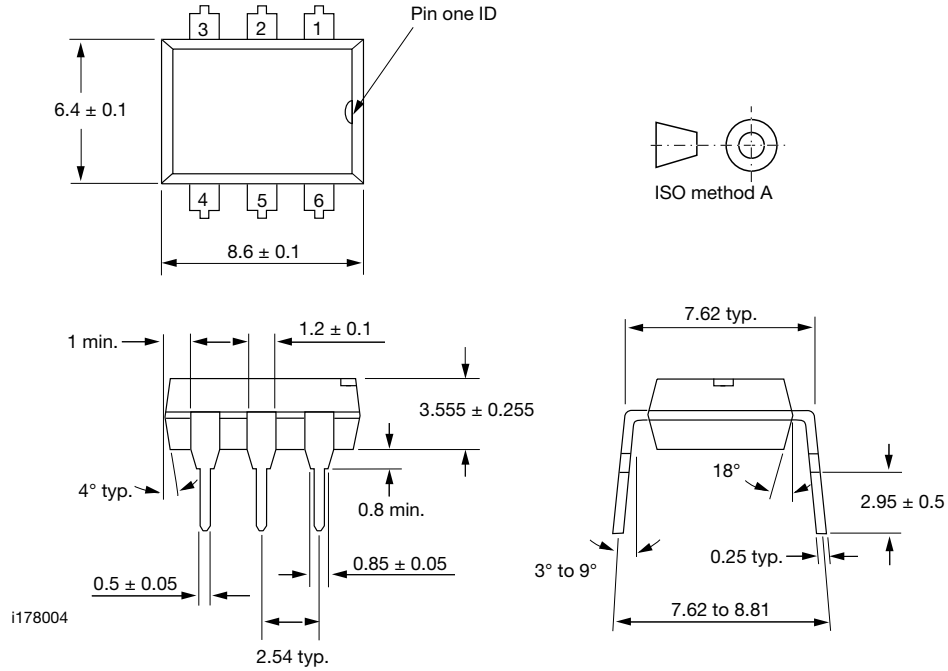

### Note

The information in this document provides generic information but for specific information on a product the appropriate product datasheet should be used.



## **Disclaimer**

ALL PRODUCT, PRODUCT SPECIFICATIONS AND DATA ARE SUBJECT TO CHANGE WITHOUT NOTICE TO IMPROVE RELIABILITY, FUNCTION OR DESIGN OR OTHERWISE.

Vishay Intertechnology, Inc., its affiliates, agents, and employees, and all persons acting on its or their behalf (collectively, "Vishay"), disclaim any and all liability for any errors, inaccuracies or incompleteness contained in any datasheet or in any other disclosure relating to any product.

Vishay makes no warranty, representation or guarantee regarding the suitability of the products for any particular purpose or the continuing production of any product. To the maximum extent permitted by applicable law, Vishay disclaims (i) any and all liability arising out of the application or use of any product, (ii) any and all liability, including without limitation special, consequential or incidental damages, and (iii) any and all implied warranties, including warranties of fitness for particular purpose, non-infringement and merchantability.

Statements regarding the suitability of products for certain types of applications are based on Vishay's knowledge of typical requirements that are often placed on Vishay products in generic applications. Such statements are not binding statements about the suitability of products for a particular application. It is the customer's responsibility to validate that a particular product with the properties described in the product specification is suitable for use in a particular application. Parameters provided in datasheets and / or specifications may vary in different applications and performance may vary over time. All operating parameters, including typical parameters, must be validated for each customer application by the customer's technical experts. Product specifications do not expand or otherwise modify Vishay's terms and conditions of purchase, including but not limited to the warranty expressed therein.

Except as expressly indicated in writing, Vishay products are not designed for use in medical, life-saving, or life-sustaining applications or for any other application in which the failure of the Vishay product could result in personal injury or death. Customers using or selling Vishay products not expressly indicated for use in such applications do so at their own risk. Please contact authorized Vishay personnel to obtain written terms and conditions regarding products designed for such applications.

No license, express or implied, by estoppel or otherwise, to any intellectual property rights is granted by this document or by any conduct of Vishay. Product names and markings noted herein may be trademarks of their respective owners.