



Frontier Electronics Corp.

667 E. COCHRAN STREET, SIMI VALLEY, CA 93065

TEL: (805) 522-9998 FAX: (805) 522-9989

E-mail: frontiersales@frontierusa.com

Web: <http://www.frontierusa.com>

1A SURFACE MOUNT SUPER FAST RECOVERY RECTIFIERS SFM11M THRU SFM19M

FEATURES

- FOR SURFACE MOUNTED APPLICATIONS
- LOW PROFILE PACKAGE
- BUILT-IN STRAIN RELIEF
- EASY PICK AND PLACE
- PLASTIC MATERIAL USED CARRIES UNDERWRITERS LABORATORY CLASSIFICATION 94 V-0
- SUPER FAST SWITCHING
- GLASS PASSIVATED CHIP JUNCTION
- HIGH TEMPERATURE SOLDERING: 250°C/10 SECONDS AT TERMINALS

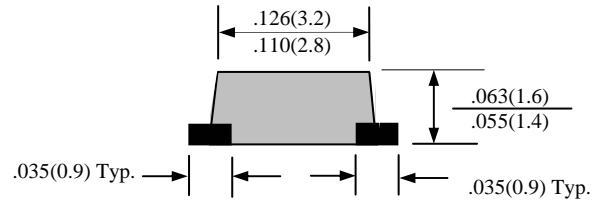
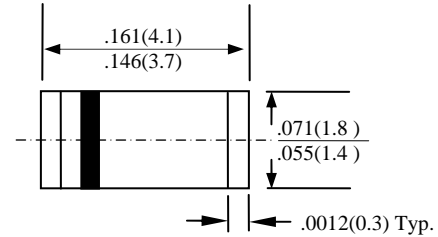

MECHANICAL DATA

- CASE: MOLDED PLASTIC, SOD-123, DIMENSIONS IN INCHES AND (MILLIMETERS)
- TERMINALS: SOLDER PLATED
- POLARITY: INDICATED BY CATHODE BAND
- WEIGHT: 0.04 GRAMS

MAXIMUM RATINGS AND ELECTRICAL CHARACTERISTICS RATINGS AT 25°C AMBIENT TEMPERATURE UNLESS OTHERWISE SPECIFIED SINGLE PHASE, HALF WAVE, 60 HZ, RESISTIVE OR INDUCTIVE LOAD. FOR CAPACITIVE LOAD, DERATE CURRENT BY 20%

RATINGS	SYMBOL	SFM11M	SFM12M	SFM13M	SFM14M	SFM15M	SFM16M	SFM18M	SFM19M	UNITS
MAXIMUM RECURRENT PEAK REVERSE VOLTAGE	V_{RRM}	50	100	150	200	300	400	600	800	V
MAXIMUM RMS VOLTAGE	V_{RMS}	35	70	105	140	210	280	420	560	V
MAXIMUM DC BLOCKING VOLTAGE	V_{DC}	50	100	150	200	300	400	600	800	V
MAXIMUM AVERAGE FORWARD RECTIFIED CURRENT AT $T_L=90^\circ\text{C}$	I_O	1.0								A
MAXIMUM OVERLOAD SURGE 8.3ms SINGLE HALF SINE-WAVE	I_{FSM}	30								A
TYPICAL JUNCTION CAPACITANCE (NOTE 1)	C_J	15				10				PF
TYPICAL THERMAL RESISTANCE (NOTE 2)	θ_{JL}	30								°C/W
STORAGE TEMPERATURE RANGE	T_{STG}	-55 TO + 150								°C
OPERATING TEMPERATURE RANGE	T_{OP}	-55 TO + 125								°C

ELECTRICAL CHARACTERISTICS ($A_T T_A = 25^\circ\text{C}$ UNLESS OTHERWISE NOTED)

CHARACTERISTICS	SYMBOL	SFM11M	SFM12M	SFM13M	SFM14M	SFM15M	SFM16M	SFM18M	SFM19M	UNITS
MAXIMUM FORWARD VOLTAGE AT 1.0A AND 25 °C	V_F	0.95			1.25		1.85			V
MAXIMUM REVERSE CURRENT AT 25 °C	I_R	5								μA
MAXIMUM REVERSE RECOVERY TIME (NOTE 3)	T_{RR}	35								nS
MARKING		S1	S2	S3	S4	S5	S6	S8	S9	

- NOTE: 1. MEASURED AT 1.0 MHZ AND APPLIED REVERSE VOLTAGE OF 4.0 V
 2. THERMAL RESISTANCE FROM JUNCTION TO TERMINAL 5.0mm² (.013 mm THICK) LAND AREAS
 3. REVERSE RECOVERY TEST CONDITIONS: $I_F=0.5\text{A}$, $I_R=1.0\text{A}$, $I_{RR}=0.25\text{A}$

RATINGS AND CHARACTERISTIC CURVE SFM11M THRU SFM19M

FIG. 1-TEST CIRCUIT DIAGRAM AND REVERSE RECOVERY TIME CHARACTERISTIC

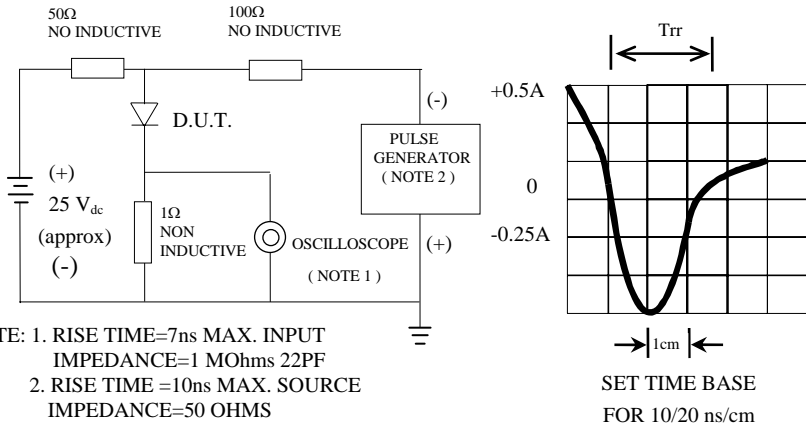

FIG. 2-TYPICAL FORWARD CURRENT DERATING CURVE

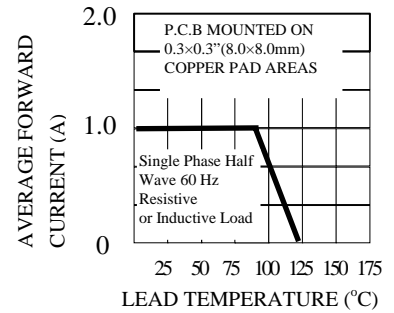

FIG. 3-TYPICAL REVERSE CHARACTERISTICS

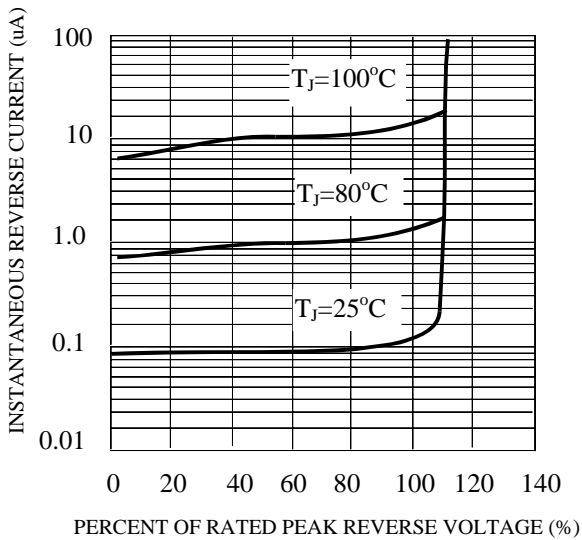

FIG. 4-TYPICAL INSTANTANEOUS FORWARD CHARACTERISTICS

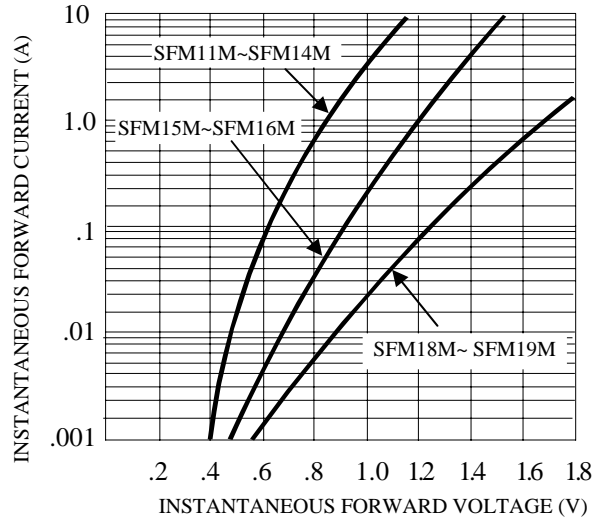

FIG. 5-MAXIMUM NON-REPETITIVE FORWARD SURGE CURRENT

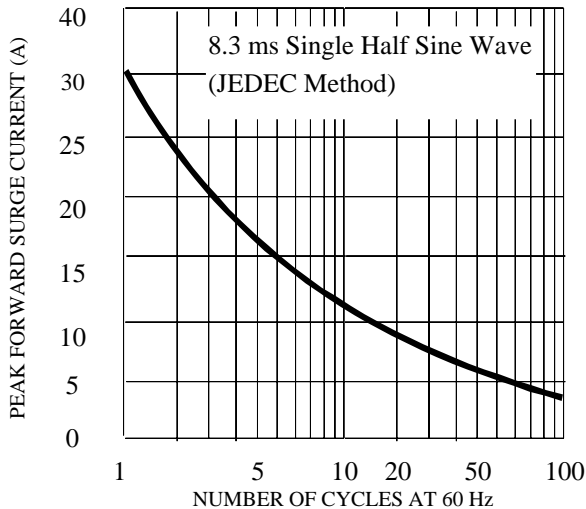

FIG. 6-TYPICAL JUNCTION CAPACITANCE

