

POSITIVE FIXED VOLTAGE REGULATOR

DESCRIPTION

The SG140A/140 series of positive regulators offer self contained, fixed-voltage capability with up to 1.5A of load current and input voltage up to 50V (SG140A series only).

These units feature a unique on-chip trimming system to set the output voltages to within $\pm 1.5\%$ of nominal on the SG140A series and $\pm 2.0\%$ on the SG140 series. The SG140A versions also offer much improved line and load regulation characteristics. Utilizing an improved Bandgap reference design, problems have been eliminated that are normally associated with the Zener Diode references, such as drift in output voltage and large changes in the line and load regulation.

All protective features of thermal shutdown, current limiting, and safe-area control have been designed into these units and since these regulators require only a small output capacitor for satisfactory performance, ease of application is assured.

Although designed as fixed-voltage regulators, the output voltage can be increased through the use of a simple voltage divider. The low quiescent drain current of the device insures good regulation when this method is used.

Product is available in hermetically sealed TO-257 (isolated), TO-3, TO-66, and TO-39 power packages.

FEATURES

- Output voltage set internally to $\pm 1.5\%$ on SG140A
- Input voltage range to 50V max. on SG140A
- Two volt input-output differential
- Bandgap reference voltage
- Excellent line and load regulation
- Foldback current limiting
- Thermal overload protection
- Voltages available - 5V, 12V, 15V
- Voltages Not Recommended For New Designs - 6V, 8V, 18V, 24V

HIGH RELIABILITY FEATURES - SG140A/140

- ◆ Available to MIL-STD - 883
- ◆ Radiation data available
- ◆ LMI level "S" processing available

SCHEMATIC DIAGRAM

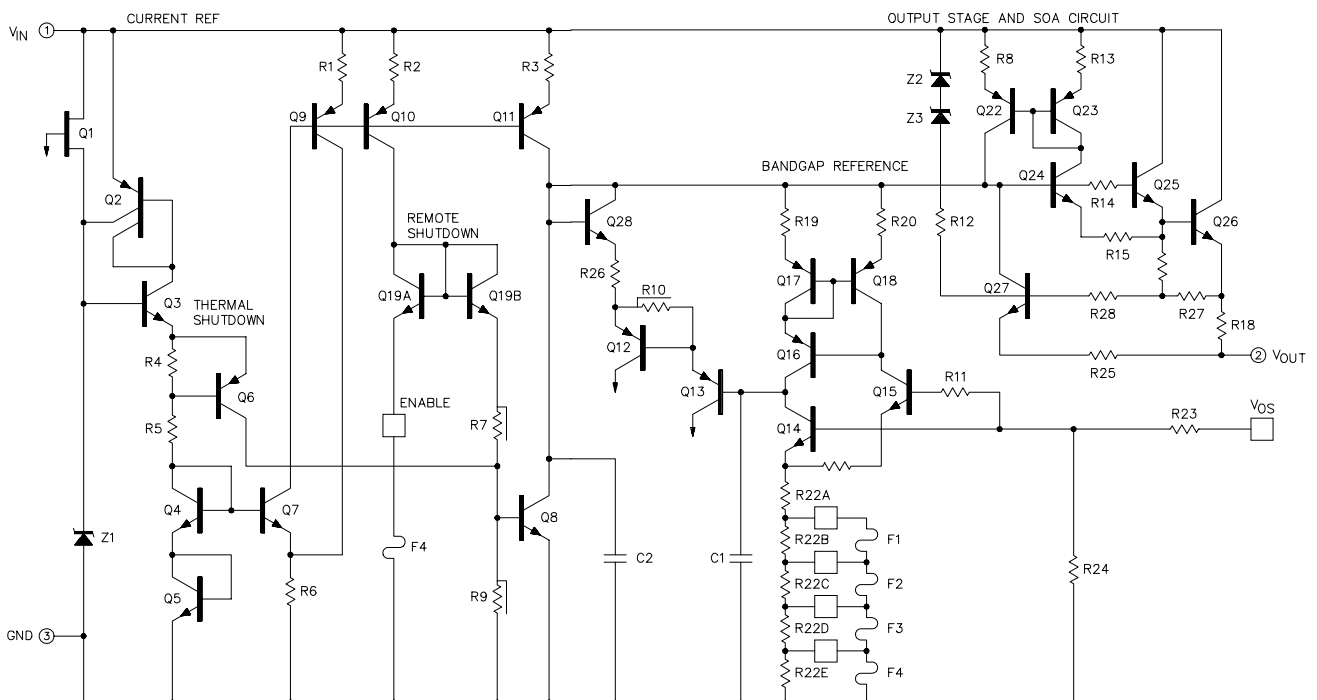

ABSOLUTE MAXIMUM RATINGS (Note 1)

Device Output Voltage	Input Voltage	Input Voltage (transient) (Note 3)	Input Voltage Differential (Output shorted to ground)
5V	35V	50V	35V
6V	35V	50V	35V
8V	35V	50V	35V
12V	35V	50V	35V
15V	35V	50V	35V
18V	35V	50V	35V
24V	40V	50V	35V

Operating Junction Temperature
 Hermetic (K, R, IG - Packages) 150°C

Storage Temperature Range -65°C to 150°C
 Lead Temperature (Soldering, 10 Seconds) 300°C

Note 1. Values beyond which damage may occur.

THERMAL DATA

- K Package:
 - Thermal Resistance-Junction to Case, θ_{JC} 3.0°C/W
 - Thermal Resistance-Junction to Ambient, θ_{JA} 35°C/W
- R Package:
 - Thermal Resistance-Junction to Case, θ_{JC} 5.0°C/W
 - Thermal Resistance-Junction to Ambient, θ_{JA} 40°C/W
- T Package:
 - Thermal Resistance-Junction to Case, θ_{JC} 15°C/W
 - Thermal Resistance-Junction to Ambient, θ_{JA} 120°C/W
- IG Package:
 - Thermal Resistance-Junction to Case, θ_{JC} 3.5°C/W
 - Thermal Resistance-Junction to Ambient, θ_{JA} 42°C/W
- L Package:
 - Thermal Resistance-Junction to Case, θ_{JC} 35°C/W
 - Thermal Resistance-Junction to Ambient, θ_{JA} 120°C/W

Note A. Junction Temperature Calculation: $T_J = T_A + (P_D \times \theta_{JA})$.
 Note B. The above numbers for θ_{JC} are maximums for the limiting thermal resistance of the package in a standard mounting configuration. The θ_{JA} numbers are meant to be guidelines for the thermal performance of the device/pc-board system. All of the above assume no ambient airflow.

RECOMMENDED OPERATING CONDITIONS (Note 2)

Operating Junction Temperature Range:
 SG140A/140 -55°C to 150°C

Note 2. Range over which the device is functional.

CHARACTERISTIC CURVES

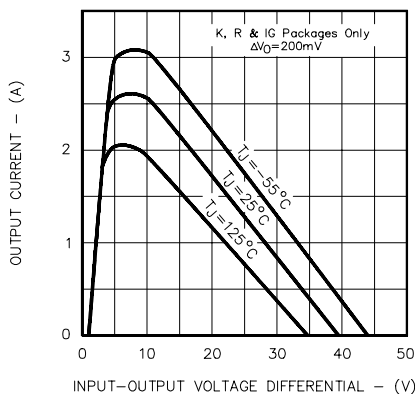

FIGURE 1.
 PEAK OUTPUT CURRENT
 VS. INPUT - OUTPUT DIFFERENTIAL

Note 3. Operation at high input voltages is dependent upon load current. When load current is less than 5mA, output will rise out of regulation as input-output differential increases beyond 30V. Note also from Figure 1, that maximum load current is reduced at high voltages. The 50V input rating of the SG140A series refers to ability to withstand high line or transient conditions without damage. Since the regulator's maximum current capability is reduced, the output may fall out of regulation at high input voltages under nominal loading.

CHARACTERISTIC CURVES (continued)

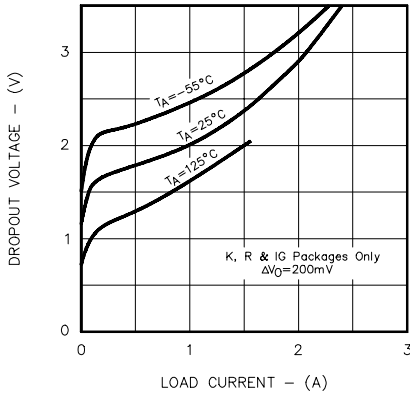

FIGURE 2. MINIMUM INPUT - OUTPUT VOLTAGE VS. LOAD CURRENT

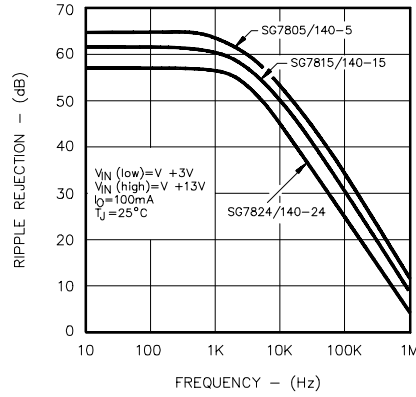

FIGURE 3. RIPPLE REJECTION VS. FREQUENCY

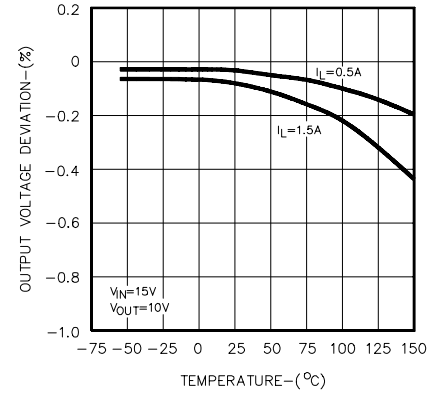
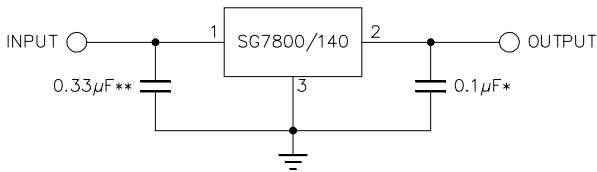

FIGURE 4. TEMPERATURE COEFFICIENT OF OUTPUT VOLTAGE

APPLICATIONS



- * INCREASING VALUE OF OUTPUT CAPACITOR IMPROVES SYSTEM TRANSIENT RESPONSE
- ** REQUIRED ONLY IF REGULATOR IS LOCATED AN APPRECIABLE DISTANCE FROM POWER SUPPLY FILTER

FIGURE 5 - FIXED OUTPUT REGULATOR

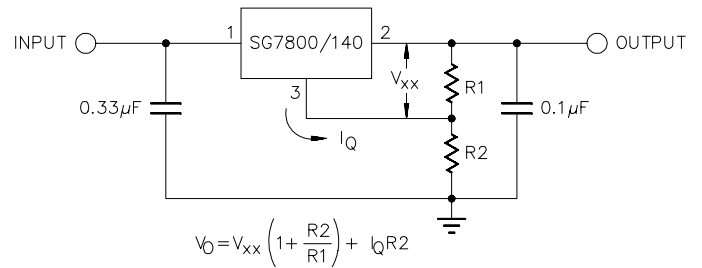

$$V_0 = V_{xx} \left(1 + \frac{R_2}{R_1} \right) + I_Q R_2$$

FIGURE 6 - CIRCUIT FOR INCREASING OUTPUT VOLTAGE

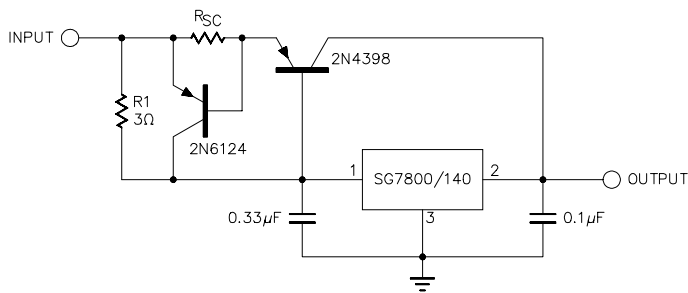

FIGURE 7 - HIGH OUTPUT CURRENT, SHORT CIRCUIT PROTECTED

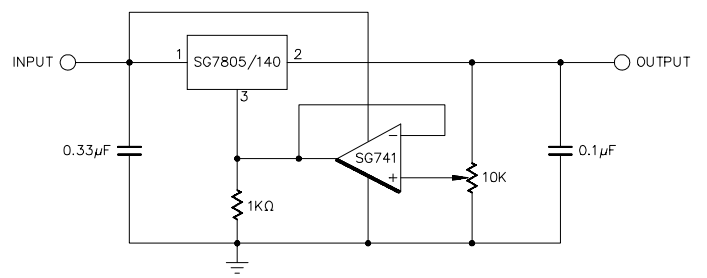

FIGURE 8 - ADJUSTABLE OUTPUT REGULATOR, 7V to 30V

ELECTRICAL CHARACTERISTICS (Note 1)

SG140A - 5

(Unless otherwise specified, these specifications apply over full operating ambient temperatures for SG140A-05 with $-55^{\circ}\text{C} \leq T_A \leq 150^{\circ}\text{C}$, $V_{IN} = 10\text{V}$, $I_O = 1.0\text{A}$, $C_{IN} = 0.33\mu\text{F}$, $C_{OUT} = 0.1\mu\text{F}$ and are applicable for the K, R, and IG - Power package - only. Low duty cycle pulse testing techniques are used which maintains junction and case temperature equal to the ambient temperature.)

Parameter	Test Conditions	SG140A-5			Units
		Min.	Typ.	Max.	
Output Voltage	$I_O = 5\text{mA to } 1.0\text{A}$, $T_J = 25^{\circ}\text{C}$	4.9	5.0	5.1	V
Line Regulation (Note 1)	$V_{IN} = 7.5\text{V to } 20\text{V}$, $I_O = 500\text{mA}$			10	mV
	$V_{IN} = 7.5\text{V to } 20\text{V}$, $T_J = 25^{\circ}\text{C}$		3	10	mV
	$V_{IN} = 7.5\text{V to } 20\text{V}$			12	mV
	$V_{IN} = 8\text{V to } 12\text{V}$, $T_J = 25^{\circ}\text{C}$			4	mV
Load Regulation (Note 1)	$I_O = 5\text{mA to } 1.0\text{A}$			25	mV
	$I_O = 5\text{mA to } 1.5\text{A}$, $T_J = 25^{\circ}\text{C}$		10	25	mV
	$I_O = 250\text{mA to } 750\text{mA}$, $T_J = 25^{\circ}\text{C}$			15	mV
Total Output Voltage Tolerance	$V_{IN} = 7.5\text{V to } 20\text{V}$, $I_O = 5\text{mA to } 1.0\text{A}$, $P \leq 15\text{W}$	4.8	5.0	5.2	V
Quiescent Current	Over Temperature Range $T_J = 25^{\circ}\text{C}$			6.5	mA
				6	mA
Quiescent Current Change	With Line: $V_{IN} = 7.5\text{V to } 25\text{V}$, $I_O = 500\text{mA}$			0.8	mA
	$V_{IN} = 7.5\text{V to } 20\text{V}$, $I_O = 1\text{A}$, $T_J = 25^{\circ}\text{C}$			0.8	mA
	With Load: $I_O = 5\text{mA to } 1.0\text{A}$			0.5	mA
Dropout Voltage	$\Delta V_O = 100\text{mV}$, $I_O = 1\text{A}$, $T_J = 25^{\circ}\text{C}$		2	2.5	V
Peak Output Current	$T_J = 25^{\circ}\text{C}$		2.4		A
Short Circuit Current	$T_J = 25^{\circ}\text{C}$		2.1		A
Ripple Rejection	$\Delta V_{IN} = 10\text{V}$, $f = 120\text{Hz}$, $T_J = 25^{\circ}\text{C}$	68			dB
Output Noise Voltage (rms)	$f = 10\text{Hz to } 100\text{KHz}$ (Note 2)			40	$\mu\text{V/V}$
Long Term Stability	1000hrs. at $T_J = 125^{\circ}\text{C}$		20		mV
Thermal Shutdown	$I_O = 5\text{mA}$		175		$^{\circ}\text{C}$

SG140 - 5

(Unless otherwise specified, these specifications apply over full operating ambient temperatures for SG140-05 with $-55^{\circ}\text{C} \leq T_A \leq 150^{\circ}\text{C}$, and $V_{IN} = 10\text{V}$, $I_O = 500\text{mA}$, $C_{IN} = 0.33\mu\text{F}$, $C_{OUT} = 0.1\mu\text{F}$ and are applicable for the K, R, and IG - Power package - only. Low duty cycle pulse testing techniques are used which maintains junction and case temperature equal to the ambient temperature.)

Parameter	Test Conditions	SG140-5			Units
		Min.	Typ.	Max.	
Output Voltage	$I_O = 5\text{mA to } 1.0\text{A}$, $T_J = 25^{\circ}\text{C}$	4.8	5.0	5.2	V
Line Regulation (Note 1)	$V_{IN} = 8\text{V to } 20\text{V}$			50	mV
	$V_{IN} = 7\text{V to } 25\text{V}$, $T_J = 25^{\circ}\text{C}$			50	mV
	$V_{IN} = 8\text{V to } 12\text{V}$, $I_O = 1.0\text{A}$			25	mV
	$V_{IN} = 7.3\text{V to } 20\text{V}$, $I_O = 1.0\text{A}$, $T_J = 25^{\circ}\text{C}$			50	mV
Load Regulation (Note 1)	$I_O = 5\text{mA to } 1.0\text{A}$			50	mV
	$I_O = 5\text{mA to } 1.5\text{A}$, $T_J = 25^{\circ}\text{C}$			50	mV
	$I_O = 250\text{mA to } 750\text{mA}$, $T_J = 25^{\circ}\text{C}$			25	mV
Total Output Voltage Tolerance	$V_{IN} = 8\text{V to } 20\text{V}$, $I_O = 5\text{mA to } 1.0\text{A}$, $P \leq 15\text{W}$	4.75	5.00	5.25	V
Quiescent Current	$I_O = 1.0\text{A}$ $T_J = 25^{\circ}\text{C}$			7	mA
				6	mA
Quiescent Current Change	With Line: $V_{IN} = 8\text{V to } 25\text{V}$			0.8	mA
	$V_{IN} = 8\text{V to } 20\text{V}$, $I_O = 1\text{A}$, $T_J = 25^{\circ}\text{C}$			0.8	mA
	With Load: $I_O = 5\text{mA to } 1.0\text{A}$			0.5	mA
Dropout Voltage	$\Delta V_O = 100\text{mV}$, $I_O = 1\text{A}$, $T_J = 25^{\circ}\text{C}$		2	2.5	V
Peak Output Current	$T_J = 25^{\circ}\text{C}$		2.4		A
Short Circuit Current	$T_J = 25^{\circ}\text{C}$		2.1		A
Ripple Rejection	$\Delta V_{IN} = 10\text{V}$, $f = 120\text{Hz}$, $T_J = 25^{\circ}\text{C}$	68			dB
Output Noise Voltage (rms)	$f = 10\text{Hz to } 100\text{KHz}$ (Note 2)			40	$\mu\text{V/V}$
Long Term Stability	1000hrs. at $T_J = 125^{\circ}\text{C}$		20		mV
Thermal Shutdown	$I_O = 5\text{mA}$		175		$^{\circ}\text{C}$

Note 1. All regulation tests are made at constant junction temperature with low duty cycle testing.

2. This test is guaranteed but is not tested in production.

ELECTRICAL CHARACTERISTICS (Note 1)

SG140 - 6

(Unless otherwise specified, these specifications apply over full operating ambient temperatures for SG140-06 with $-55^{\circ}\text{C} \leq T_A \leq 150^{\circ}\text{C}$, and $V_{IN} = 11\text{V}$, $I_O = 500\text{mA}$, $C_{IN} = 0.33\mu\text{F}$, $C_{OUT} = 0.1\mu\text{F}$ and are applicable for the K, R, and IG - Power package - only. Low duty cycle pulse testing techniques are used which maintains junction and case temperature equal to the ambient temperature.)

Parameter	Test Conditions	SG140 - 6			Units
		Min.	Typ.	Max.	
Output Voltage	$I_O = 5\text{mA to } 1.0\text{A}$, $T_J = 25^{\circ}\text{C}$	5.75	6.00	6.25	V
Line Regulation (Note 1)	$V_{IN} = 9\text{V to } 21\text{V}$			60	mV
	$V_{IN} = 8\text{V to } 25\text{V}$, $T_J = 25^{\circ}\text{C}$			60	mV
	$V_{IN} = 9\text{V to } 13\text{V}$, $I_O = 1.0\text{A}$			30	mV
Load Regulation (Note 1)	$V_{IN} = 8.3\text{V to } 21\text{V}$, $I_O = 1.0\text{A}$, $T_J = 25^{\circ}\text{C}$			60	mV
	$I_O = 5\text{mA to } 1.0\text{A}$			60	mV
	$I_O = 5\text{mA to } 1.5\text{A}$, $T_J = 25^{\circ}\text{C}$			60	mV
Total Output Voltage				30	mV
Tolerance	$V_{IN} = 9\text{V to } 21\text{V}$, $I_O = 5\text{mA to } 1.0\text{A}$, $P \leq 15\text{W}$	5.7	6.0	6.3	V
Quiescent Current	$I_O = 1.0\text{A}$			7	mA
	$T_J = 25^{\circ}\text{C}$			6	mA
Quiescent Current Change	With Line: $V_{IN} = 9\text{V to } 25\text{V}$			0.8	mA
	$V_{IN} = 9\text{V to } 21\text{V}$, $I_O = 1\text{A}$, $T_J = 25^{\circ}\text{C}$			0.8	mA
	With Load: $I_O = 5\text{mA to } 1.0\text{A}$			0.5	mA
Dropout Voltage	$\Delta V_O = 100\text{mV}$, $I_O = 1\text{A}$, $T_J = 25^{\circ}\text{C}$		2	2.5	V
Peak Output Current	$T_J = 25^{\circ}\text{C}$		2.4		A
Short Circuit Current	$T_J = 25^{\circ}\text{C}$		2.1		A
Ripple Rejection	$\Delta V_{IN} = 10\text{V}$, $f = 120\text{Hz}$, $T_J = 25^{\circ}\text{C}$	65			dB
Output Noise Voltage (rms)	$f = 10\text{Hz to } 100\text{KHz}$ (Note 2)			40	$\mu\text{V/V}$
Long Term Stability	1000hrs. at $T_J = 125^{\circ}\text{C}$		24		mV
Thermal Shutdown	$I_O = 5\text{mA}$		175		$^{\circ}\text{C}$

SG140 - 8

(Unless otherwise specified, these specifications apply over full operating ambient temperatures for SG140-08 with $-55^{\circ}\text{C} \leq T_A \leq 150^{\circ}\text{C}$, and $V_{IN} = 14\text{V}$, $I_O = 500\text{mA}$, $C_{IN} = 0.33\mu\text{F}$, $C_{OUT} = 0.1\mu\text{F}$ and are applicable for the K, R, and IG - Power package - only. Low duty cycle pulse testing techniques are used which maintains junction and case temperature equal to the ambient temperature.)

Parameter	Test Conditions	SG140 - 8			Units
		Min.	Typ.	Max.	
Output Voltage	$I_O = 5\text{mA to } 1.0\text{A}$, $T_J = 25^{\circ}\text{C}$	7.7	8.0	8.3	V
Line Regulation (Note 1)	$V_{IN} = 11\text{V to } 23\text{V}$			80	mV
	$V_{IN} = 10.5\text{V to } 25\text{V}$, $T_J = 25^{\circ}\text{C}$			80	mV
	$V_{IN} = 11\text{V to } 17\text{V}$, $I_O = 1.0\text{A}$			40	mV
Load Regulation (Note 1)	$V_{IN} = 10.5\text{V to } 23\text{V}$, $I_O = 1.0\text{A}$, $T_J = 25^{\circ}\text{C}$			80	mV
	$I_O = 5\text{mA to } 1.0\text{A}$			80	mV
	$I_O = 5\text{mA to } 1.5\text{A}$, $T_J = 25^{\circ}\text{C}$			80	mV
Total Output Voltage	$I_O = 250\text{mA to } 750\text{mA}$, $T_J = 25^{\circ}\text{C}$			40	mV
Tolerance	$V_{IN} = 11.5\text{V to } 23\text{V}$, $I_O = 5\text{mA to } 1.0\text{A}$, $P \leq 15\text{W}$	7.6	8.0	8.4	V
Quiescent Current	$I_O = 1.0\text{A}$			7	mA
	$T_J = 25^{\circ}\text{C}$			6	mA
Quiescent Current Change	With Line: $V_{IN} = 11.5\text{V to } 25\text{V}$			0.8	mA
	$V_{IN} = 11.5\text{V to } 23\text{V}$, $I_O = 1\text{A}$, $T_J = 25^{\circ}\text{C}$			0.8	mA
	With Load: $I_O = 5\text{mA to } 1.0\text{A}$			0.5	mA
Dropout Voltage	$\Delta V_O = 100\text{mV}$, $I_O = 1\text{A}$, $T_J = 25^{\circ}\text{C}$		2	2.5	V
Peak Output Current	$T_J = 25^{\circ}\text{C}$		2.4		A
Short Circuit Current	$T_J = 25^{\circ}\text{C}$		2.1		A
Ripple Rejection	$\Delta V_{IN} = 10\text{V}$, $f = 120\text{Hz}$, $T_J = 25^{\circ}\text{C}$	62			dB
Output Noise Voltage (rms)	$f = 10\text{Hz to } 100\text{KHz}$ (Note 2)			40	$\mu\text{V/V}$
Long Term Stability	1000hrs. at $T_J = 125^{\circ}\text{C}$		32		mV
Thermal Shutdown	$I_O = 5\text{mA}$		175		$^{\circ}\text{C}$

Note 1. All regulation tests are made at constant junction temperature with low duty cycle testing.
 2. This test is guaranteed but is not tested in production.

ELECTRICAL CHARACTERISTICS (Note 1)

SG140 A - 12

(Unless otherwise specified, these specifications apply over full operating ambient temperatures for SG140A -12 with $-55^{\circ}\text{C} \leq T_A \leq 150^{\circ}\text{C}$, and $V_{IN} = 19\text{V}$, $I_O = 1.0\text{A}$, $C_{IN} = 0.33\mu\text{F}$, $C_{OUT} = 0.1\mu\text{F}$ and are applicable for the K, R, and IG - Power package - only. Low duty cycle pulse testing techniques are used which maintains junction and case temperature equal to the ambient temperature.)

Parameter	Test Conditions	SG140A - 12			Units
		Min.	Typ.	Max.	
Output Voltage	$I_O = 5\text{mA to } 1.0\text{A}$, $T_J = 25^{\circ}\text{C}$	11.75	12.00	12.25	V
Line Regulation (Note 1)	$V_{IN} = 14.8\text{V to } 27\text{V}$, $I_O = 500\text{mA}$			18	mV
	$V_{IN} = 14.5\text{V to } 27\text{V}$, $T_J = 25^{\circ}\text{C}$		4	18	mV
	$V_{IN} = 16\text{V to } 22\text{V}$			30	mV
	$V_{IN} = 16\text{V to } 22\text{V}$, $T_J = 25^{\circ}\text{C}$			9	mV
Load Regulation (Note 1)	$I_O = 5\text{mA to } 1.0\text{A}$			60	mV
	$I_O = 5\text{mA to } 1.5\text{A}$, $T_J = 25^{\circ}\text{C}$			32	mV
	$I_O = 250\text{mA to } 750\text{mA}$, $T_J = 25^{\circ}\text{C}$			19	mV
Total Output Voltage Tolerance	$V_{IN} = 14.8\text{V to } 27\text{V}$, $I_O = 5\text{mA to } 1.0\text{A}$, $P \leq 15\text{W}$	11.5	12.0	12.5	V
Quiescent Current	Over Temperature Range $T_J = 25^{\circ}\text{C}$			6.5	mA
				6	mA
Quiescent Current Change	With Line: $V_{IN} = 15\text{V to } 30\text{V}$, $I_O = 500\text{mA}$			0.8	mA
	$V_{IN} = 14.8\text{V to } 27\text{V}$, $I_O = 1\text{A}$, $T_J = 25^{\circ}\text{C}$			0.8	mA
	With Load: $I_O = 5\text{mA to } 1.0\text{A}$			0.5	mA
Dropout Voltage	$\Delta V_O = 100\text{mV}$, $I_O = 1\text{A}$, $T_J = 25^{\circ}\text{C}$		2	2.5	V
Peak Output Current	$T_J = 25^{\circ}\text{C}$		2.4		A
Short Circuit Current	$T_J = 25^{\circ}\text{C}$		2.1		A
Ripple Rejection	$\Delta V_{IN} = 10\text{V}$, $f = 120\text{Hz}$, $T_J = 25^{\circ}\text{C}$	61			dB
Output Noise Voltage (rms)	$f = 10\text{Hz to } 100\text{KHz}$ (Note 2)			40	$\mu\text{V/V}$
Long Term Stability	1000hrs. at $T_J = 125^{\circ}\text{C}$		48		mV
Thermal Shutdown	$I_O = 5\text{mA}$		175		$^{\circ}\text{C}$

SG140 - 12

(Unless otherwise specified, these specifications apply over full operating ambient temperatures for SG140-12 with $-55^{\circ}\text{C} \leq T_A \leq 150^{\circ}\text{C}$, and $V_{IN} = 19\text{V}$, $I_O = 500\text{mA}$, $C_{IN} = 0.33\mu\text{F}$, $C_{OUT} = 0.1\mu\text{F}$ and are applicable for the K, R, and IG - Power package - only. Low duty cycle pulse testing techniques are used which maintains junction and case temperature equal to the ambient temperature.)

Parameter	Test Conditions	SG140 - 12			Units
		Min.	Typ.	Max.	
Output Voltage	$I_O = 5\text{mA to } 1.0\text{A}$, $T_J = 25^{\circ}\text{C}$	11.5	12.0	12.5	V
Line Regulation (Note 1)	$V_{IN} = 15\text{V to } 27\text{V}$			120	mV
	$V_{IN} = 14.5\text{V to } 30\text{V}$, $T_J = 25^{\circ}\text{C}$			120	mV
	$V_{IN} = 16\text{V to } 22\text{V}$, $I_O = 1.0\text{A}$			60	mV
	$V_{IN} = 14.6\text{V to } 27\text{V}$, $I_O = 1.0\text{A}$, $T_J = 25^{\circ}\text{C}$			120	mV
Load Regulation (Note 1)	$I_O = 5\text{mA to } 1.0\text{A}$			120	mV
	$I_O = 5\text{mA to } 1.5\text{A}$, $T_J = 25^{\circ}\text{C}$			120	mV
	$I_O = 250\text{mA to } 750\text{mA}$, $T_J = 25^{\circ}\text{C}$			60	mV
Total Output Voltage Tolerance	$V_{IN} = 14.5\text{V to } 27\text{V}$, $I_O = 5\text{mA to } 1.0\text{A}$, $P \leq 15\text{W}$	11.4	12.0	12.6	V
Quiescent Current	$I_O = 1.0\text{A}$ $T_J = 25^{\circ}\text{C}$			7	mA
				6	mA
Quiescent Current Change	With Line: $V_{IN} = 15\text{V to } 30\text{V}$			0.8	mA
	$V_{IN} = 14.5\text{V to } 27\text{V}$, $I_O = 1\text{A}$, $T_J = 25^{\circ}\text{C}$			0.8	mA
	With Load: $I_O = 5\text{mA to } 1.0\text{A}$			0.5	mA
Dropout Voltage	$\Delta V_O = 100\text{mV}$, $I_O = 1\text{A}$, $T_J = 25^{\circ}\text{C}$		2	2.5	V
Peak Output Current	$T_J = 25^{\circ}\text{C}$		2.4		A
Short Circuit Current	$T_J = 25^{\circ}\text{C}$		2.1		A
Ripple Rejection	$\Delta V_{IN} = 10\text{V}$, $f = 120\text{Hz}$, $T_J = 25^{\circ}\text{C}$	61			dB
Output Noise Voltage (rms)	$f = 10\text{Hz to } 100\text{KHz}$ (Note 2)			40	$\mu\text{V/V}$
Long Term Stability	1000hrs. at $T_J = 125^{\circ}\text{C}$		48		mV
Thermal Shutdown	$I_O = 5\text{mA}$		175		$^{\circ}\text{C}$

Note 1. All regulation tests are made at constant junction temperature with low duty cycle testing.
2. This test is guaranteed but is not tested in production.

SG140A/SG140 SERIES

15V POSITIVE REGULATOR

ELECTRICAL CHARACTERISTICS (Note 1)

SG140 A - 15

(Unless otherwise specified, these specifications apply over full operating ambient temperatures for SG140A -15 with $-55^{\circ}\text{C} \leq T_A \leq 150^{\circ}\text{C}$, and $V_{IN} = 23\text{V}$, $I_O = 1.0\text{A}$, $C_{IN} = 0.33\mu\text{F}$, $C_{OUT} = 0.1\mu\text{F}$ and are applicable for the K, R, and IG - Power package - only. Low duty cycle pulse testing techniques are used which maintains junction and case temperature equal to the ambient temperature.)

Parameter	Test Conditions	SG140A - 15			Units
		Min.	Typ.	Max.	
Output Voltage	$I_O = 5\text{mA to } 1.0\text{A}$, $T_J = 25^{\circ}\text{C}$	14.7	15.0	15.3	V
Line Regulation (Note 1)	$V_{IN} = 17.9\text{V to } 30\text{V}$, $I_O = 500\text{mA}$			22	mV
	$V_{IN} = 7.5\text{V to } 30\text{V}$, $T_J = 25^{\circ}\text{C}$			22	mV
	$V_{IN} = 20\text{V to } 26\text{V}$			30	mV
	$V_{IN} = 20\text{V to } 26\text{V}$, $T_J = 25^{\circ}\text{C}$			10	mV
Load Regulation (Note 1)	$I_O = 5\text{mA to } 1.0\text{A}$			75	mV
	$I_O = 5\text{mA to } 1.5\text{A}$, $T_J = 25^{\circ}\text{C}$			35	mV
	$I_O = 250\text{mA to } 750\text{mA}$, $T_J = 25^{\circ}\text{C}$			21	mV
Total Output Voltage Tolerance	$V_{IN} = 17.9\text{V to } 30\text{V}$, $I_O = 5\text{mA to } 1.0\text{A}$, $P \leq 15\text{W}$	14.4	15.0	15.6	V
Quiescent Current	Over Temperature Range			6.5	mA
	$T_J = 25^{\circ}\text{C}$			6	mA
Quiescent Current Change	With Line: $V_{IN} = 17.9\text{V to } 30\text{V}$, $I_O = 500\text{mA}$			0.8	mA
	$V_{IN} = 17.9\text{V to } 30\text{V}$, $I_O = 1\text{A}$, $T_J = 25^{\circ}\text{C}$			0.8	mA
	With Load: $I_O = 5\text{mA to } 1.0\text{A}$			0.5	mA
Dropout Voltage	$\Delta V_O = 100\text{mV}$, $I_O = 1\text{A}$, $T_J = 25^{\circ}\text{C}$		2	2.5	V
Peak Output Current	$T_J = 25^{\circ}\text{C}$		2.4		A
Short Circuit Current	$T_J = 25^{\circ}\text{C}$		2.1		A
Ripple Rejection	$\Delta V_{IN} = 10\text{V}$, $f = 120\text{Hz}$, $T_J = 25^{\circ}\text{C}$	60			dB
Output Noise Voltage (rms)	$f = 10\text{Hz to } 100\text{KHz}$ (Note 2)			40	$\mu\text{V/V}$
Long Term Stability	1000hrs. at $T_J = 125^{\circ}\text{C}$		60		mV
Thermal Shutdown	$I_O = 5\text{mA}$		175		$^{\circ}\text{C}$

SG140 - 15

(Unless otherwise specified, these specifications apply over full operating ambient temperatures for SG140-15 with $-55^{\circ}\text{C} \leq T_A \leq 150^{\circ}\text{C}$, and $V_{IN} = 23\text{V}$, $I_O = 500\text{mA}$, $C_{IN} = 0.33\mu\text{F}$, $C_{OUT} = 0.1\mu\text{F}$ and are applicable for the K, R, and IG - Power package - only. Low duty cycle pulse testing techniques are used which maintains junction and case temperature equal to the ambient temperature.)

Parameter	Test Conditions	SG140 - 15			Units
		Min.	Typ.	Max.	
Output Voltage	$I_O = 5\text{mA to } 1.0\text{A}$, $T_J = 25^{\circ}\text{C}$	14.4	15.0	15.6	V
Line Regulation (Note 1)	$V_{IN} = 18.5\text{V to } 30\text{V}$			150	mV
	$V_{IN} = 17.5\text{V to } 30\text{V}$, $T_J = 25^{\circ}\text{C}$			150	mV
	$V_{IN} = 20\text{V to } 26\text{V}$, $I_O = 1.0\text{A}$			75	mV
	$V_{IN} = 17.7\text{V to } 30\text{V}$, $I_O = 1.0\text{A}$, $T_J = 25^{\circ}\text{C}$			150	mV
Load Regulation (Note 1)	$I_O = 5\text{mA to } 1.0\text{A}$			150	mV
	$I_O = 5\text{mA to } 1.5\text{A}$, $T_J = 25^{\circ}\text{C}$			150	mV
	$I_O = 250\text{mA to } 750\text{mA}$, $T_J = 25^{\circ}\text{C}$			75	mV
Total Output Voltage Tolerance	$V_{IN} = 17.5\text{V to } 30\text{V}$, $I_O = 5\text{mA to } 1.0\text{A}$, $P \leq 15\text{W}$	14.25	15.00	15.75	V
Quiescent Current	$I_O = 1.0\text{A}$			8.5	mA
	$T_J = 25^{\circ}\text{C}$			8	mA
Quiescent Current Change	With Line: $V_{IN} = 18.5\text{V to } 30\text{V}$			1.0	mA
	$V_{IN} = 18.5\text{V to } 30\text{V}$, $I_O = 1\text{A}$, $T_J = 25^{\circ}\text{C}$			1.0	mA
	With Load: $I_O = 5\text{mA to } 1.0\text{A}$			0.5	mA
Dropout Voltage	$\Delta V_O = 100\text{mV}$, $I_O = 1\text{A}$, $T_J = 25^{\circ}\text{C}$		2	2.5	V
Peak Output Current	$T_J = 25^{\circ}\text{C}$		2.4		A
Short Circuit Current	$T_J = 25^{\circ}\text{C}$		2.1		A
Ripple Rejection	$\Delta V_{IN} = 10\text{V}$, $f = 120\text{Hz}$, $T_J = 25^{\circ}\text{C}$	54			dB
Output Noise Voltage (rms)	$f = 10\text{Hz to } 100\text{KHz}$ (Note 2)			40	$\mu\text{V/V}$
Long Term Stability	1000hrs. at $T_J = 125^{\circ}\text{C}$		60		mV
Thermal Shutdown	$I_O = 5\text{mA}$		175		$^{\circ}\text{C}$

Note 1. All regulation tests are made at constant junction temperature with low duty cycle testing.
2. This test is guaranteed but is not tested in production.

ELECTRICAL CHARACTERISTICS (Note 1)

SG140 - 18

(Unless otherwise specified, these specifications apply over full operating ambient temperatures for SG140-18 with $-55^{\circ}\text{C} \leq T_A \leq 150^{\circ}\text{C}$, and $V_{IN} = 27\text{V}$, $I_O = 500\text{mA}$, $C_{IN} = 0.33\mu\text{F}$, $C_{OUT} = 0.1\mu\text{F}$ and are applicable for the K, R, and IG - Power package - only. Low duty cycle pulse testing techniques are used which maintains junction and case temperature equal to the ambient temperature.)

Parameter	Test Conditions	SG140 - 18			Units
		Min.	Typ.	Max.	
Output Voltage	$I_O = 5\text{mA to } 1.0\text{A}, T_J = 25^{\circ}\text{C}$	17.3	18.0	18.7	V
Line Regulation (Note 1)	$V_{IN} = 21.5\text{V to } 33\text{V}$			180	mV
	$V_{IN} = 21\text{V to } 33\text{V}, T_J = 25^{\circ}\text{C}$			180	mV
	$V_{IN} = 24\text{V to } 30\text{V}, I_O = 1.0\text{A}$			90	mV
Load Regulation (Note 1)	$V_{IN} = 21\text{V to } 30\text{V}, I_O = 1.0\text{A}, T_J = 25^{\circ}\text{C}$			180	mV
	$I_O = 5\text{mA to } 1.0\text{A}$			180	mV
	$I_O = 5\text{mA to } 1.5\text{A}, T_J = 25^{\circ}\text{C}$			180	mV
	$I_O = 250\text{mA to } 750\text{mA}, T_J = 25^{\circ}\text{C}$			90	mV
Total Output Voltage Tolerance	$V_{IN} = 21\text{V to } 33\text{V}, I_O = 5\text{mA to } 1.0\text{A}, P \leq 15\text{W}$	17.1	18.0	18.9	V
Quiescent Current	$I_O = 1\text{A}$			7	mA
	$T_J = 25^{\circ}\text{C}$			6	mA
Quiescent Current Change	With Line: $V_{IN} = 21\text{V to } 33\text{V}$			0.8	mA
	$V_{IN} = 21\text{V to } 33\text{V}, I_O = 1\text{A}, T_J = 25^{\circ}\text{C}$			0.8	mA
	With Load: $I_O = 5\text{mA to } 1.0\text{A}$			0.5	mA
Dropout Voltage	$\Delta V_O = 100\text{mV}, I_O = 1\text{A}, T_J = 25^{\circ}\text{C}$		2	2.5	V
Peak Output Current	$T_J = 25^{\circ}\text{C}$		2.4		A
Short Circuit Current	$T_J = 25^{\circ}\text{C}$		2.1		A
Ripple Rejection	$\Delta V_{IN} = 10\text{V}, f = 120\text{Hz}, T_J = 25^{\circ}\text{C}$	59			dB
Output Noise Voltage (rms)	$f = 10\text{Hz to } 100\text{KHz}$ (Note 2)			40	$\mu\text{V/V}$
Long Term Stability	1000hrs. at $T_J = 125^{\circ}\text{C}$		72		mV
Thermal Shutdown	$I_O = 5\text{mA}$		175		$^{\circ}\text{C}$

SG140 - 24

(Unless otherwise specified, these specifications apply over full operating ambient temperatures for SG140-24 with $-55^{\circ}\text{C} \leq T_A \leq 150^{\circ}\text{C}$, and $V_{IN} = 33\text{V}$, $I_O = 500\text{mA}$, $C_{IN} = 0.33\mu\text{F}$, $C_{OUT} = 0.1\mu\text{F}$ and are applicable for the K, R, and IG - Power package - only. Low duty cycle pulse testing techniques are used which maintains junction and case temperature equal to the ambient temperature.)

Parameter	Test Conditions	SG140 - 24			Units
		Min.	Typ.	Max.	
Output Voltage	$I_O = 5\text{mA to } 1.0\text{A}, T_J = 25^{\circ}\text{C}$	23	24	25	V
Line Regulation (Note 1)	$V_{IN} = 28\text{V to } 38\text{V}$			240	mV
	$V_{IN} = 27\text{V to } 38\text{V}, T_J = 25^{\circ}\text{C}$			240	mV
	$V_{IN} = 30\text{V to } 36\text{V}, I_O = 1.0\text{A}$			120	mV
	$V_{IN} = 27.1\text{V to } 35\text{V}, I_O = 1.0\text{A}, T_J = 25^{\circ}\text{C}$			240	mV
Load Regulation (Note 1)	$I_O = 5\text{mA to } 1.0\text{A}$			240	mV
	$I_O = 5\text{mA to } 1.5\text{A}, T_J = 25^{\circ}\text{C}$			240	mV
	$I_O = 250\text{mA to } 750\text{mA}, T_J = 25^{\circ}\text{C}$			120	mV
Total Output Voltage Tolerance	$V_{IN} = 27\text{V to } 38\text{V}, I_O = 5\text{mA to } 1.0\text{A}, P \leq 15\text{W}$	22.8	24.0	25.2	V
Quiescent Current	$I_O = 1.0\text{A}$			7	mA
	$T_J = 25^{\circ}\text{C}$			6	mA
Quiescent Current Change	With Line: $V_{IN} = 27\text{V to } 38\text{V}$			0.8	mA
	$V_{IN} = 28\text{V to } 38\text{V}, I_O = 1\text{A}, T_J = 25^{\circ}\text{C}$			0.8	mA
	With Load: $I_O = 5\text{mA to } 1.0\text{A}$			0.5	mA
Dropout Voltage	$\Delta V_O = 100\text{mV}, I_O = 1\text{A}, T_J = 25^{\circ}\text{C}$		2	2.5	V
Peak Output Current	$T_J = 25^{\circ}\text{C}$		2.4		A
Short Circuit Current	$T_J = 25^{\circ}\text{C}$		2.1		A
Ripple Rejection	$\Delta V_{IN} = 10\text{V}, f = 120\text{Hz}, T_J = 25^{\circ}\text{C}$	56			dB
Output Noise Voltage (rms)	$f = 10\text{Hz to } 100\text{KHz}$ (Note 2)			40	$\mu\text{V/V}$
Long Term Stability	1000hrs. at $T_J = 125^{\circ}\text{C}$		96		mV
Thermal Shutdown	$I_O = 5\text{mA}$		175		$^{\circ}\text{C}$

Note 1. All regulation tests are made at constant junction temperature with low duty cycle testing.
2. This test is guaranteed but is not tested in production.

SG140A/SG140 SERIES

POSITIVE REGULATOR

CONNECTION DIAGRAMS & ORDERING INFORMATION (See Notes Below)

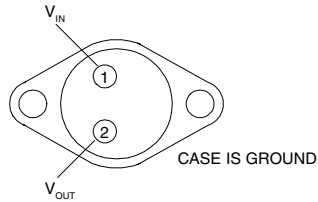
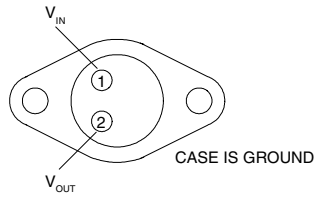
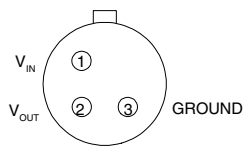
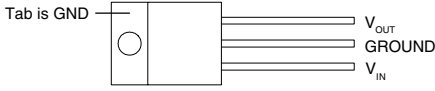
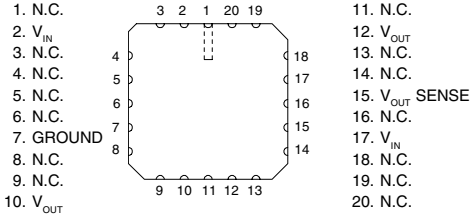
Package	Part No.	Ambient Temperature Range	Connection Diagram
3-TERMINAL TO-3 METAL CAN K-PACKAGE	SG140-XXK/883B SG140-XXK	-55°C to 125°C -55°C to 125°C	
3-TERMINAL TO-66 METAL CAN R-PACKAGE	SG140-XXR/883B SG140-XXR	-55°C to 125°C -55°C to 125°C	
3-PIN TO-39 METAL CAN T-PACKAGE	SG140-XXT/883B SG140-XXT	-55°C to 125°C -55°C to 125°C	
3-PIN HERMETIC TO-257 IG-PACKAGE (Isolated)	SG140A-XXIG/883B SG140A-XXIG SG140-XXIG/883B SG140-XXIG	-55°C to 125°C -55°C to 125°C -55°C to 125°C -55°C to 125°C	
20-PIN CERAMIC (LCC) LEADLESS CHIP CARRIER L- PACKAGE	SG140-XXL/883B SG140-XXL	-55°C to 125°C -55°C to 125°C	(Note 4) 

- Note 1. Contact factory for JAN and DESC product availability.
 2. All parts are viewed from the top.
 3. "XX" to be replaced by output voltage of specific fixed regulator.
 4. Some products will be available in leadless chip carrier (LCC). Consult factory for price and availability.