

SGM2005

Low Power, Low Dropout, 150mA, RF - Linear Regulators

GENERAL DESCRIPTION

The SGM2005 series low-power, low-noise, low-dropout, CMOS linear voltage regulators operate from a 2.5V to 5.5V input and deliver up to 150mA. They are the perfect choice for low voltage, low power applications. An ultra low ground current (150 μ A at 150mA output) makes these parts attractive for battery operated power systems. The SGM2005 series also offer ultra low dropout voltage (150mV at 150mA output) to prolong battery life in portable electronics. Systems requiring a quiet voltage source, such as RF applications, will benefit from the SGM2005 series' ultra low output noise (30 μ VRMS) and high PSRR. An external noise bypass capacitor connected to the device's BP pin can further reduce the noise level.

The output voltage is preset to voltages in the range of 1.5V to 5.0V. Other features include a 10nA logic-controlled shutdown mode, foldback current limit and thermal shut-down protection.

Devices come in 6-pin DFN-6 package.

APPLICATIONS

Cellular Telephones
Cordless Telephones
PCS Telephones
PCMCIA Cards
Modems
MP3 Player
Hand-Held Instruments
Palmtop Computers
Electronic Planners
Portable/Battery-Powered Equipment

FEATURES

- Low Output Noise: 30 μ VRMS typ(10Hz to 100KHz)
- Ultra-Low Dropout Voltage:
150mV at 150mA output
- Low 77 μ A No-Load Supply Current
- Low 150 μ A Operating Supply Current
at 150mA Output
- High PSRR: 73dB at 1KHz
- Thermal-Overload Protection
- Output Current Limit
- Preset Output Voltages (\pm 2.7% Accuracy)
- 10nA Logic-Controlled Shutdown
- Available in Multiple Output Voltage Versions
Fixed Outputs of 1.8V, 2.5V, 2.8V, 3.0V and 3.3V

PIN CONFIGURATIONS (TOP VIEW)

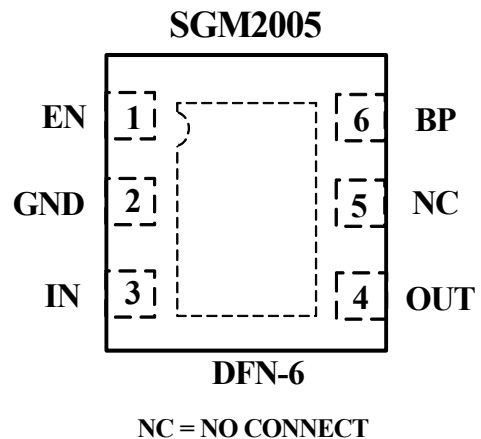

ORDERING INFORMATION

MODEL	V _{OUT} (V)	PIN-PACKAGE	SPECIFIED TEMPERATURE RANGE	ORDERING NUMBER	PACKAGE MARKING	PACKAGE OPTION
SGM2005-1.8	1.8V	DFN-6	- 40°C to +85°C	SGM2005-1.8YD6/TR	Y518	Tape and Reel, 3000
SGM2005-2.5	2.5V	DFN-6	- 40°C to +85°C	SGM2005-2.5YD6/TR	Y525	Tape and Reel, 3000
SGM2005-2.8	2.8V	DFN-6	- 40°C to +85°C	SGM2005-2.8YD6/TR	Y528	Tape and Reel, 3000
SGM2005-3.0	3.0V	DFN-6	- 40°C to +85°C	SGM2005-3.0YD6/TR	Y530	Tape and Reel, 3000
SGM2005-3.3	3.3V	DFN-6	- 40°C to +85°C	SGM2005-3.3YD6/TR	Y533	Tape and Reel, 3000

ABSOLUTE MAXIMUM RATINGS

IN to GND.....- 0.3V to +6V
 Output Short-Circuit DurationInfinite
 EN to GND.....- 0.3V to +6V
 OUT, BP to GND.....- 0.3V to (V_{IN} + 0.3V)
 Power Dissipation, PD @ T_A = 25° C
 DFN-6 300mW
 Package Thermal Resistance

DFN-6, θ_{JA}200°C/W
 Operating Temperature Range.....- 40°C to +85°C
 Junction Temperature.....+150°C
 Storage Temperature.....- 65°C to +150°C
 Lead Temperature (soldering, 10s).....+260°C
 ESD Rating.....4 kV

Stresses beyond those listed under “Absolute Maximum Ratings” may cause permanent damage to the device. These are stress ratings only, and functional operation of the device at these or any other conditions beyond those indicated in the operational sections of the specifications is not implied. Exposure to absolute maximum rating conditions for extended periods may affect device reliability.

TYPICAL OPERATION CIRCUIT

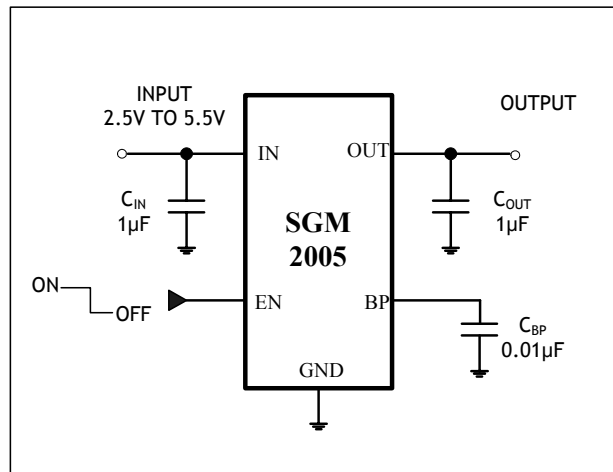

ELECTRICAL CHARACTERISTICS

($V_{IN} = V_{OUT(NOMINAL)} + 0.5V^{(1)}$, $T_A = -40^{\circ}C$ to $+85^{\circ}C$, unless otherwise noted. Typical values are at $T_A = +25^{\circ}C$.)

PARAMETER	SYMBOL	CONDITIONS	MIN	TYP	MAX	UNITS	
Input Voltage	V_{IN}		2.5		5.5	V	
Output Voltage Accuracy ⁽¹⁾		$I_{OUT} = 1mA$ to $150mA$, $T_A = +25^{\circ}C$ $V_{OUT} + 0.5V \leq V_{IN} \leq 5.5V$	-2.7		+2.7	%	
Maximum Output Current			150			mA	
Current Limit	I_{LIM}		160	600		mA	
Ground Pin Current	I_Q	No load, $EN = 2V$		77	145	μA	
		$I_{OUT} = 150mA$, $EN = 2V$		150			
Dropout Voltage ⁽²⁾		$I_{OUT} = 1mA$		1		mV	
		$I_{OUT} = 150mA$		150	190		
Line Regulation ⁽¹⁾	ΔV_{LNR}	$V_{IN} = 2.5V$ or ($V_{OUT} + 0.5V$) to $5.5V$, $I_{OUT} = 1mA$		0.03	0.15	%/V	
Load Regulation	ΔV_{LDR}	$I_{OUT} = 0.1mA$ to $150mA$, $C_{OUT} = 1\mu F$		0.0008	0.002	%/mA	
Output Voltage Noise	e_n	$f = 10Hz$ to $100KHz$, $C_{BP} = 0.01\mu F$, $C_{OUT} = 10\mu F$		30		$\mu VRMS$	
Power Supply Rejection Rate	PSRR	$C_{BP} = 0.1\mu F$, $I_{LOAD} = 50mA$, $C_{OUT} = 1\mu F$	$f = 100Hz$,		78		dB
			$f = 1KHz$,		73		dB
SHUTDOWN							
EN Input Threshold	V_{IH}	$V_{IN} = 2.5V$ to $5.5V$	2.0		0.4	V	
	V_{IL}						
EN Input Bias Current	$I_{B(SHDN)}$	$EN = 0V$ and $EN = 5.5V$	$T_A = +25^{\circ}C$		0.01	1	μA
			$T_A = +85^{\circ}C$		0.01		
Shutdown Supply Current	$I_{Q(SHDN)}$	$EN = 0.4V$	$T_A = +25^{\circ}C$		0.01	1	μA
			$T_A = +85^{\circ}C$		0.01		
Shutdown Exit Delay ⁽³⁾		$C_{BP} = 0.01\mu F$ $C_{OUT} = 1\mu F$, No load	$T_A = +25^{\circ}C$		30	μs	
THERMAL PROTECTION							
Thermal Shutdown Temperature	T_{SHDN}			160		$^{\circ}C$	
Thermal Shutdown Hysteresis	ΔT_{SHDN}			15		$^{\circ}C$	

Specifications subject to change without notice.

Note 1: $V_{IN} = V_{OUT(NOMINAL)} + 0.5V$ or $2.5V$, whichever is greater.

Note 2: The dropout voltage is defined as $V_{IN} - V_{OUT}$, when V_{OUT} is $100mV$ below the value of V_{OUT} for $V_{IN} = V_{OUT} + 0.5V$. (Only applicable for $V_{OUT} = +2.5V$ to $+3.3V$.)

Note 3: Time needed for V_{OUT} to reach 95% of final value.

TYPICAL OPERATING CHARACTERISTICS

$V_{IN} = V_{OUT(NOMINAL)} + 0.5V$ or $2.5V$ (whichever is greater), $C_{IN} = 1\mu F$, $C_{OUT} = 1\mu F$, $C_{BP} = 0.01\mu F$, $T_A = +25^\circ C$, unless otherwise noted.

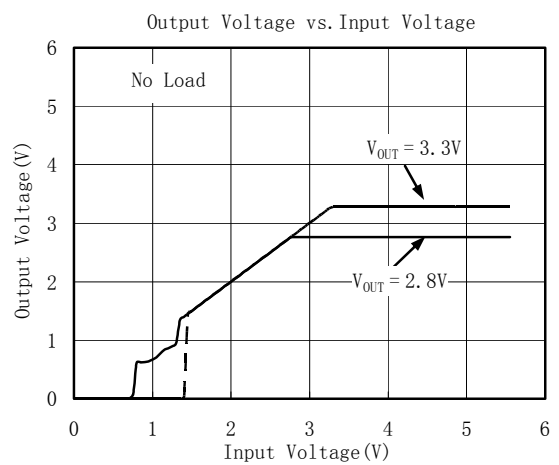
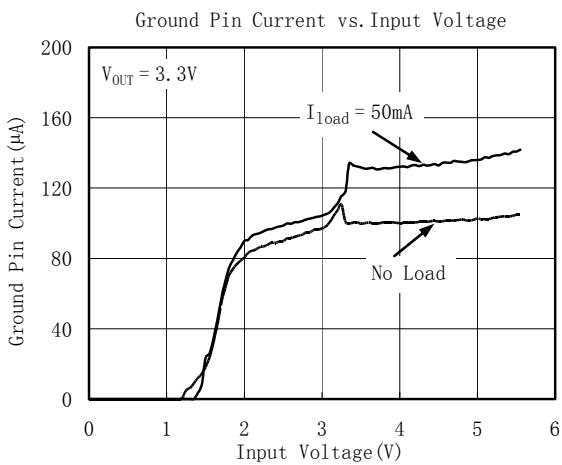
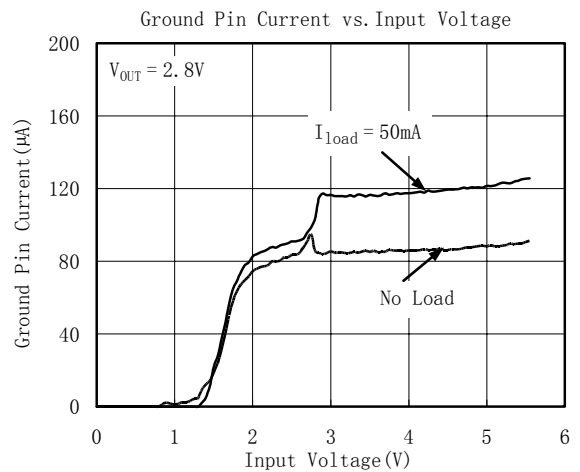
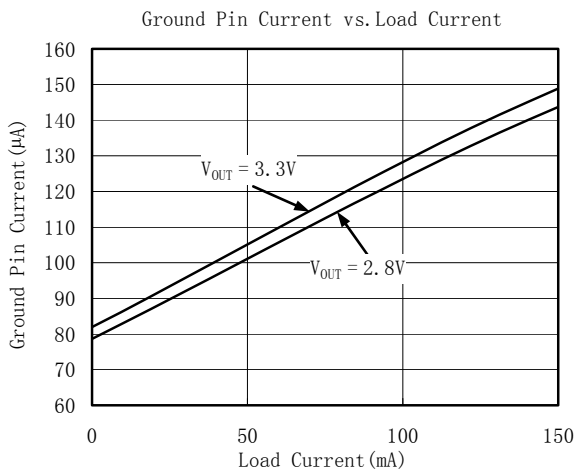
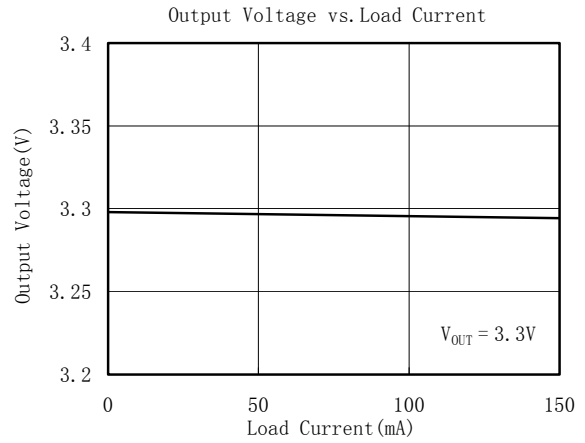
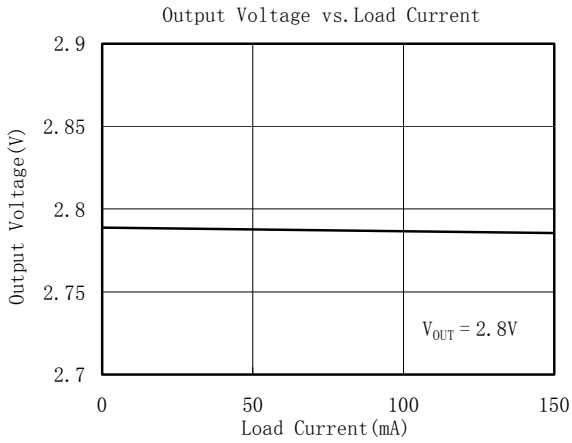

TYPICAL OPERATING CHARACTERISTICS

$V_{IN} = V_{OUT(NOMINAL)} + 0.5V$ or $2.5V$ (whichever is greater), $C_{IN} = 1\mu F$, $C_{OUT} = 1\mu F$, $C_{BP} = 0.01\mu F$, $T_A = +25^\circ C$, unless otherwise noted.

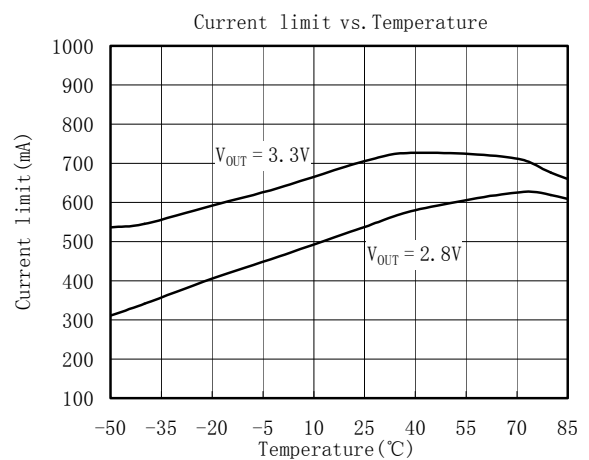
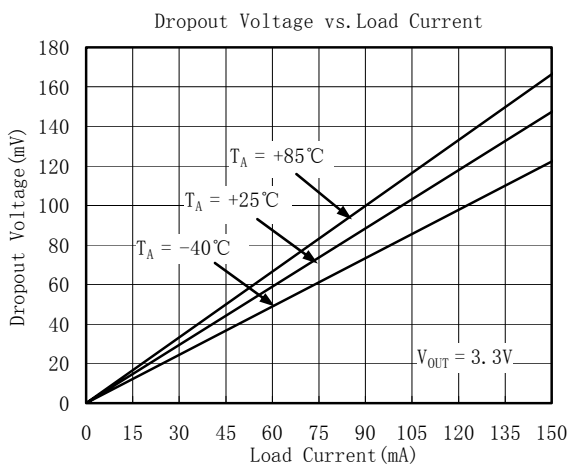
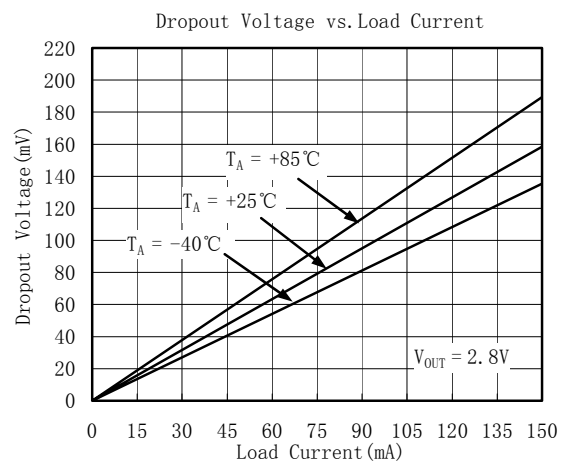
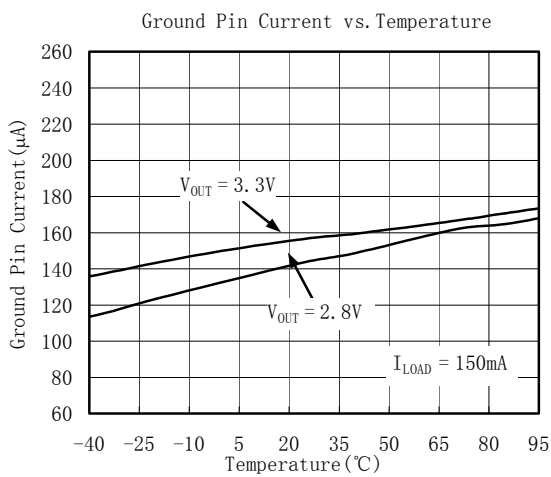
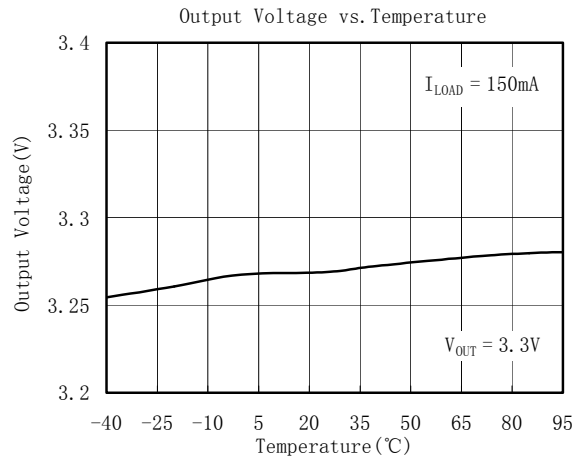
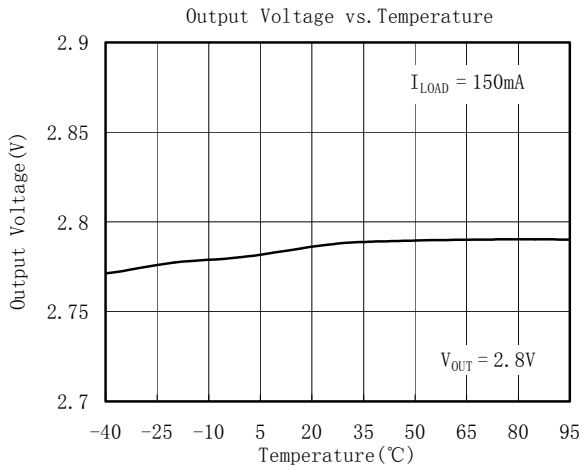

TYPICAL OPERATING CHARACTERISTICS

$V_{IN} = V_{OUT(NOMINAL)} + 0.5V$ or $2.5V$ (whichever is greater), $C_{IN} = 1\mu F$, $C_{OUT} = 1\mu F$, $C_{BP} = 0.01\mu F$, $T_A = +25^\circ C$, unless otherwise noted.

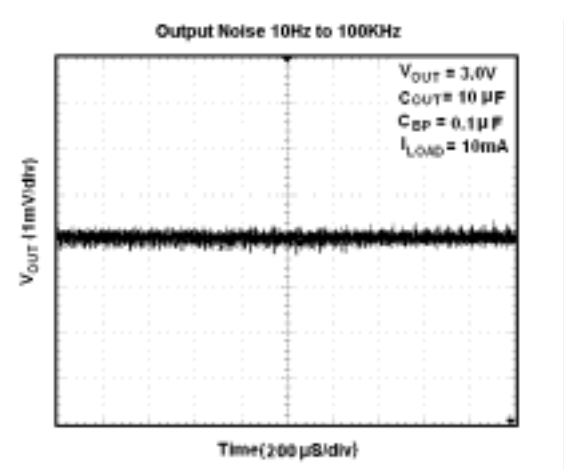
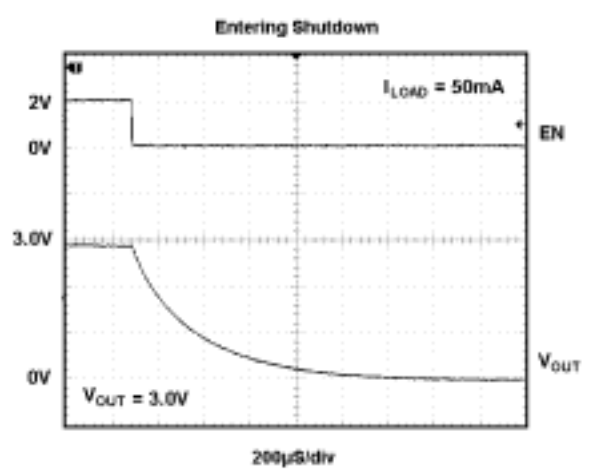
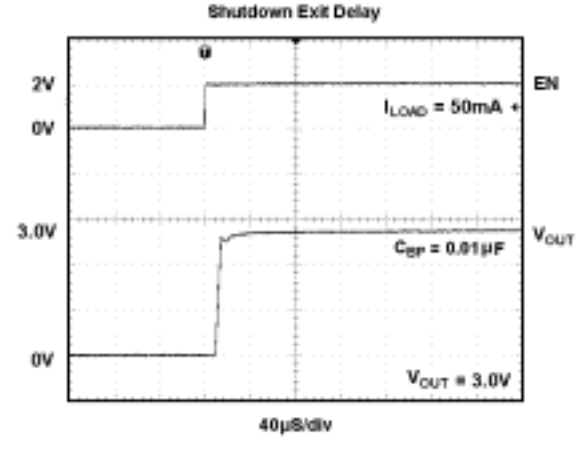
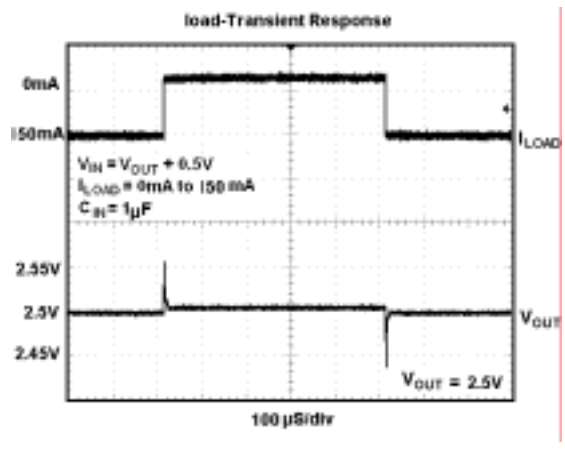
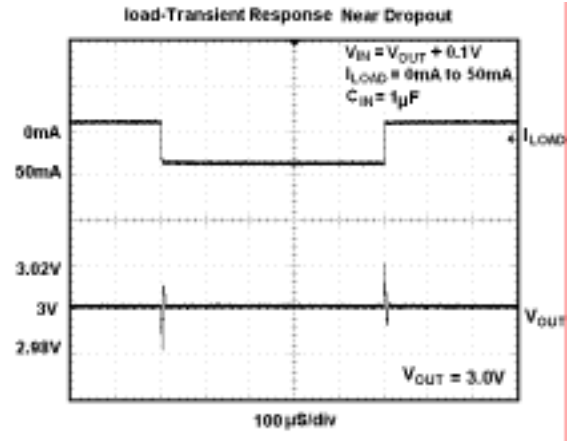
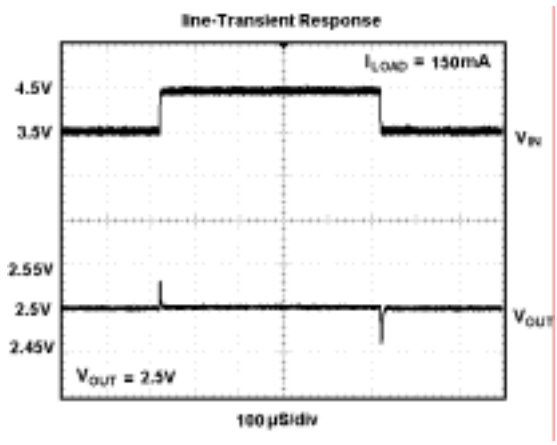

TYPICAL OPERATING CHARACTERISTICS

$V_{IN} = V_{OUT(NOMINAL)} + 0.5V$ or $2.5V$ (whichever is greater), $C_{IN} = 1\mu F$, $C_{OUT} = 1\mu F$, $C_{BP} = 0.01\mu F$, $T_A = +25^\circ C$, unless otherwise noted.

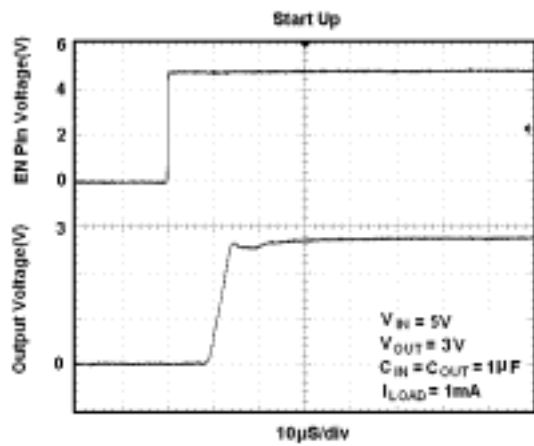
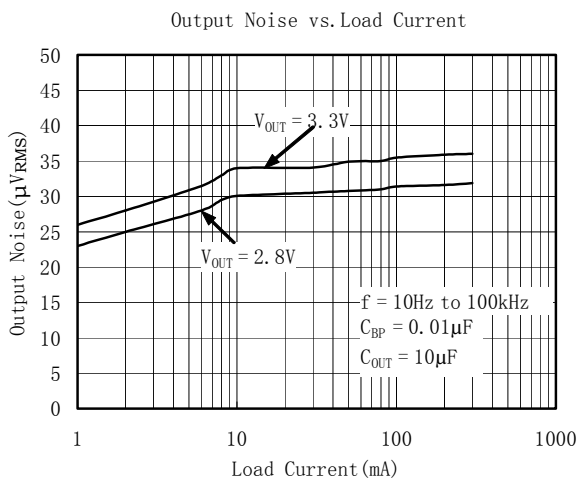
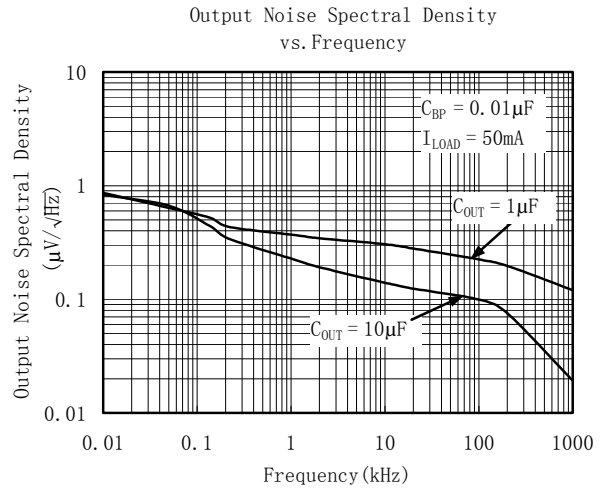
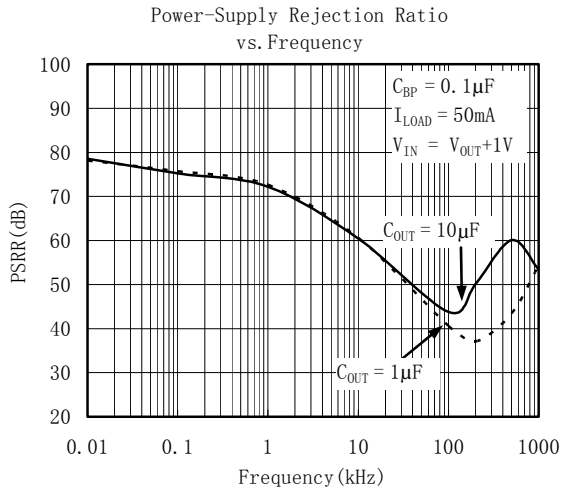

Application Notes

When LDO is used in handheld products, Attention must be paid to voltage spike which would damage SGM2005. In such applications, voltage spike will be generated at charger interface and V_{BUS} pin of USB interface when charger adapters and USB equipments are hot-inserted. Besides this, handheld products will be tested on the production line on the condition of no battery. Test Engineer will apply power from the connector pin which connects with positive pole of the battery. When external power supply is turned on suddenly, the voltage spike will be generated at the battery connector. The voltage spike will be very high, it always exceeds the absolute maximum input voltage (6.0V) of LDO. In order to get robust design. Design Engineer needs to clear up this voltage spike. Zener diode is a cheap and effective solution to eliminate such voltage spike. For example, BZM55B5V6 is a 5.6V small package Zener diode which can be used to remove voltage spike in cell phone design. The schematic is shown in below:

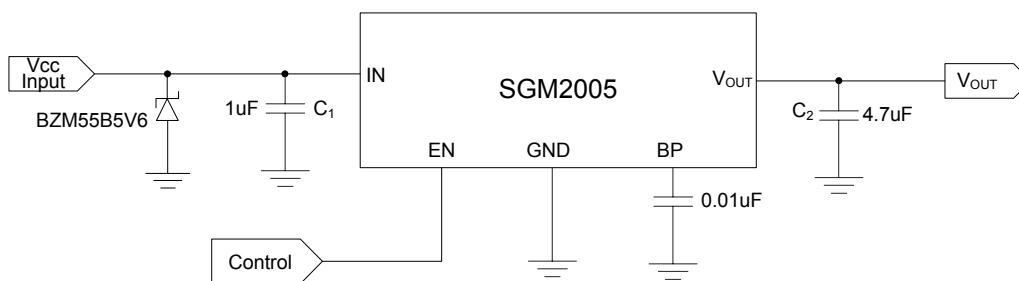

PACKAGE OUTLINE DIMENSIONS

DFN-6

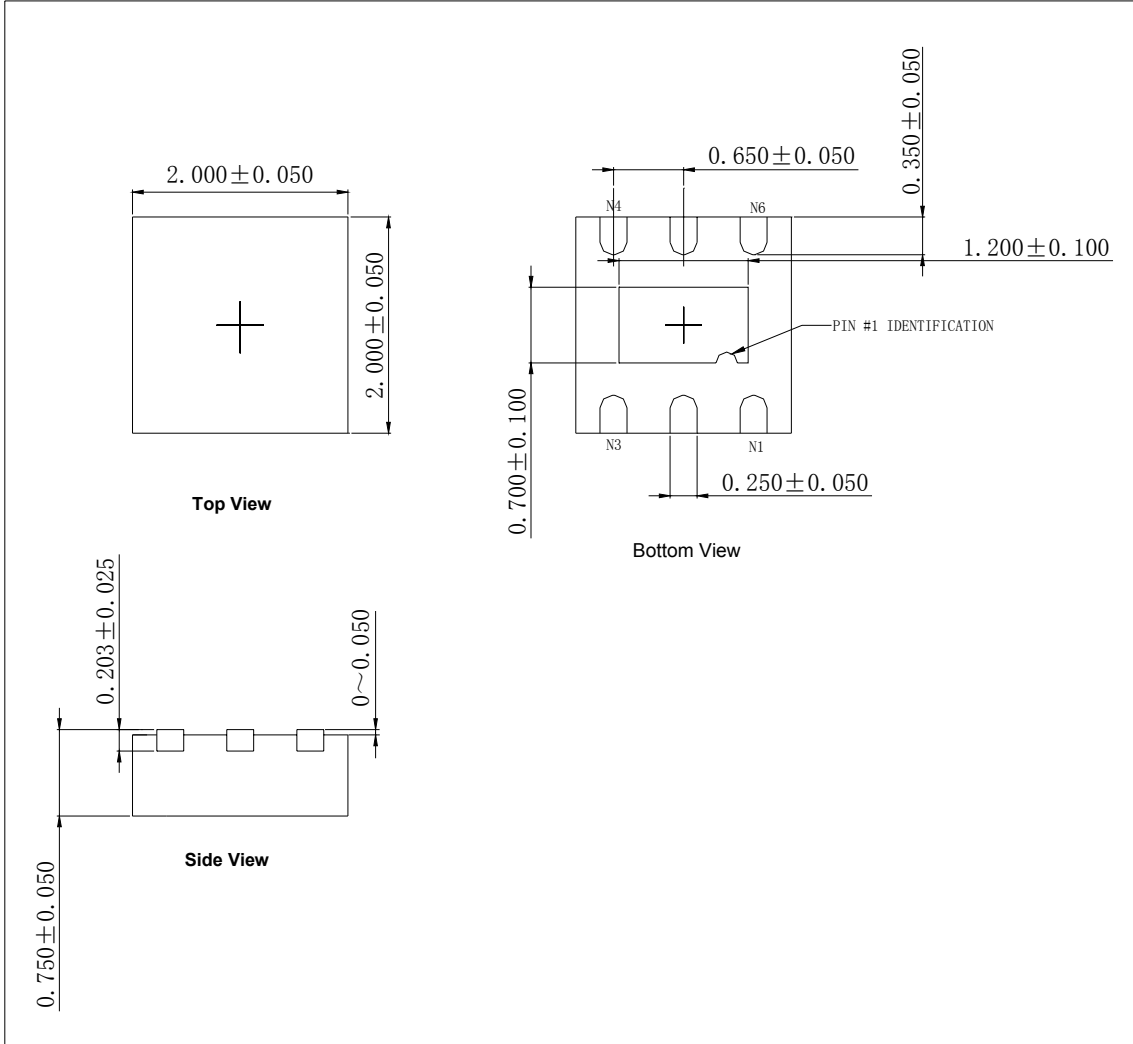

NOTES:

1. All dimensions are in millimeters.

REVISION HISTORY

Location	Page
03/07— Data Sheet changed from REV. A to REV. B	
Changed to TYPICAL OPERATING CHARACTERISTICS	6

Shengbang Microelectronics Co, Ltd

Unit 3, ChuangYe Plaza
No.5, TaiHu Northern Street, YingBin Road Centralized Industrial Park
Harbin Development Zone
Harbin, HeiLongJiang 150078
P.R. China
Tel.: 86-451-84348461
Fax: 86-451-84308461
www.sg-micro.com