



P-Channel 30-V (D-S) MOSFET

PRODUCT SUMMARY		
V_{DS} (V)	$r_{DS(on)}$ (Ω)	I_D (A)
-30	0.0085 @ $V_{GS} = -10$ V	-14
	0.014 @ $V_{GS} = -4.5$ V	-11

FEATURES

- TrenchFET® Power MOSFET
- ESD Protection: 3000 V

APPLICATIONS

- Notebook PC
 - Load Switch
 - Adapter Switch

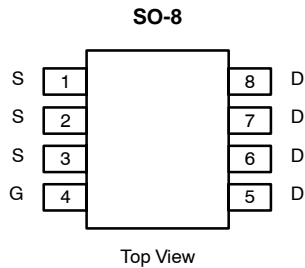

Ordering Information: Si4483EDY-T1—E3

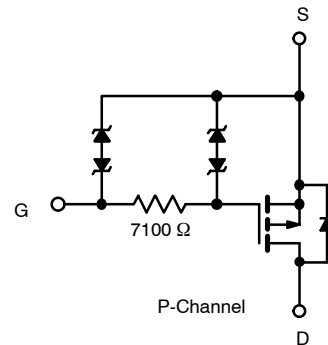

ABSOLUTE MAXIMUM RATINGS ($T_A = 25^\circ\text{C}$ UNLESS OTHERWISE NOTED)					
Parameter	Symbol	10 secs	Steady State	Unit	
Drain-Source Voltage	V_{DS}	-30		V	
Gate-Source Voltage	V_{GS}	± 25			
Continuous Drain Current ($T_J = 150^\circ\text{C}$) ^a	I_D	$T_A = 25^\circ\text{C}$	-14	-10	A
		$T_A = 70^\circ\text{C}$	-11	-8	
Pulsed Drain Current	I_{DM}	-50		W	
Continuous Source Current (Diode Conduction) ^a	I_S	-2.7	-1.36		
Maximum Power Dissipation ^a	P_D	$T_A = 25^\circ\text{C}$	3.0	1.5	W
		$T_A = 70^\circ\text{C}$	1.9	0.95	
Operating Junction and Storage Temperature Range	T_J, T_{stg}	-55 to 150		$^\circ\text{C}$	

THERMAL RESISTANCE RATINGS					
Parameter	Symbol	Typical	Maximum	Unit	
Maximum Junction-to-Ambient ^a	R_{thJA}	$t \leq 10$ sec	33	42	$^\circ\text{C/W}$
		Steady State	70	85	
Maximum Junction-to-Foot (Drain)	R_{thJF}	16	21		

Notes

a. Surface Mounted on 1" x 1" FR4 Board.

SPECIFICATIONS (T_J = 25 °C UNLESS OTHERWISE NOTED)

Parameter	Symbol	Test Condition	Min	Typ	Max	Unit
Static						
Gate Threshold Voltage	V _{GS(th)}	V _{DS} = V _{GS} , I _D = -250 μA	-1.0		3.0	V
Gate-Body Leakage	I _{GSS}	V _{DS} = 0 V, V _{GS} = ±4.5 V			±1	μA
		V _{DS} = 0 V, V _{GS} = ±25 V			±10	mA
Zero Gate Voltage Drain Current	I _{DSS}	V _{DS} = -30 V, V _{GS} = 0 V			-1	μA
		V _{DS} = -30 V, V _{GS} = 0 V, T _J = 70 °C			-10	μA
On-State Drain Current ^a	I _{D(on)}	V _{DS} = -5 V, V _{GS} = -10 V	-30			A
Drain-Source On-State Resistance ^a	r _{DS(on)}	V _{GS} = -10 V, I _D = -14 A		0.007	0.0085	Ω
		V _{GS} = -4.5 V, I _D = -11 A		0.0115	0.014	Ω
Forward Transconductance ^a	g _{fs}	V _{DS} = -15 V, I _D = -14 A		60		S
Diode Forward Voltage ^a	V _{SD}	I _S = -2.7 A, V _{GS} = 0 V		-0.74	-1.1	V
Dynamic^b						
Turn-On Delay Time	t _{d(on)}	V _{DD} = -15 V, R _L = 15 Ω I _D ≅ -1 A, V _{GEN} = -10 V, R _g = 6 Ω		10	15	μs
Rise Time	t _r			20	30	
Turn-Off Delay Time	t _{d(off)}			42	65	
Fall Time	t _f			50	80	

Notes

- a. Pulse test; pulse width ≤ 300 μs, duty cycle ≤ 2%.
b. Guaranteed by design, not subject to production testing.

Stresses beyond those listed under "Absolute Maximum Ratings" may cause permanent damage to the device. These are stress ratings only, and functional operation of the device at these or any other conditions beyond those indicated in the operational sections of the specifications is not implied. Exposure to absolute maximum rating conditions for extended periods may affect device reliability.

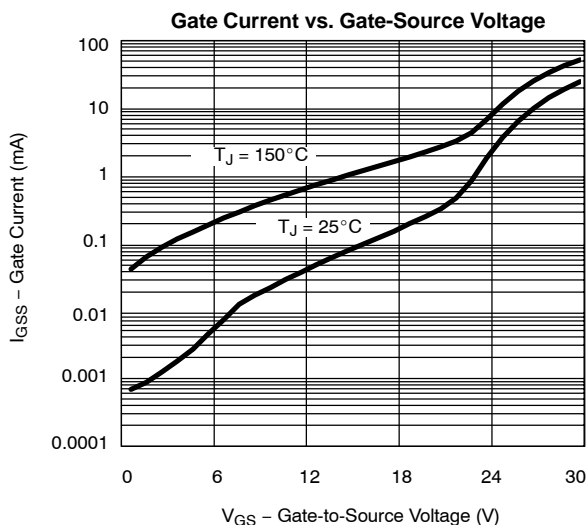
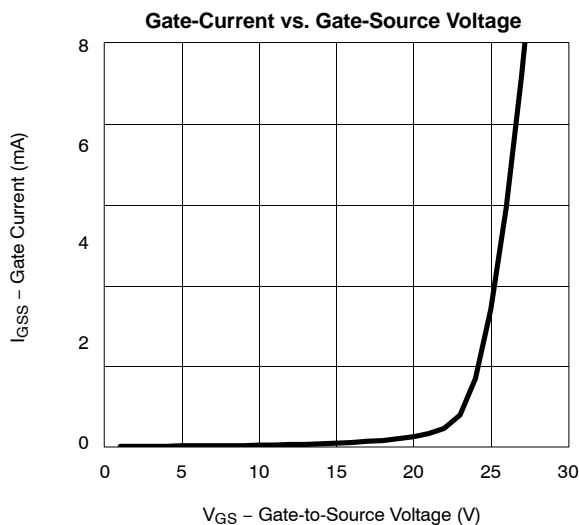
TYPICAL CHARACTERISTICS (25 °C UNLESS NOTED)



TYPICAL CHARACTERISTICS (25°C UNLESS NOTED)

Output Characteristics

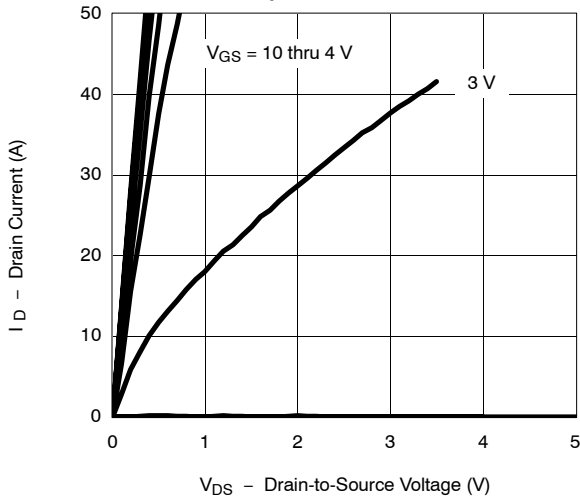

Transfer Characteristics

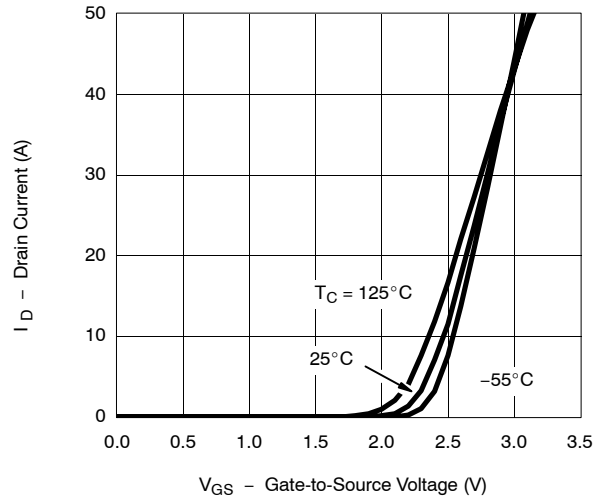

On-Resistance vs. Drain Current

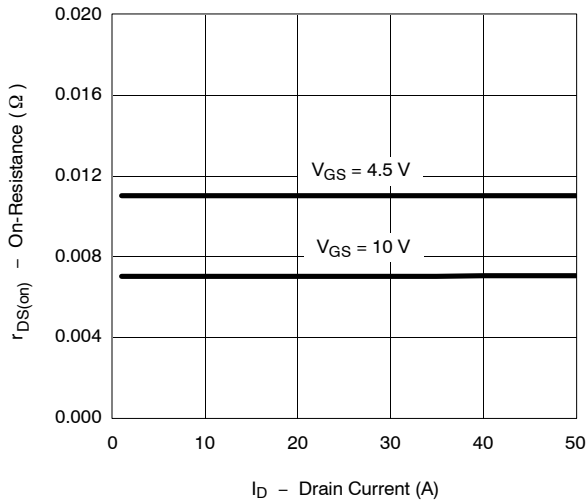

On-Resistance vs. Junction Temperature

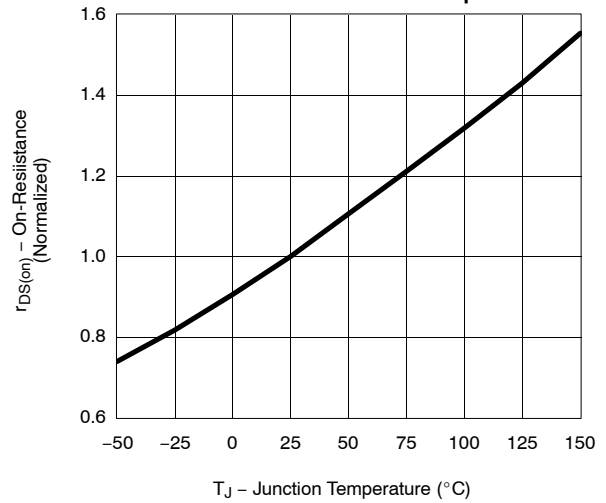

Source-Drain Diode Forward Voltage

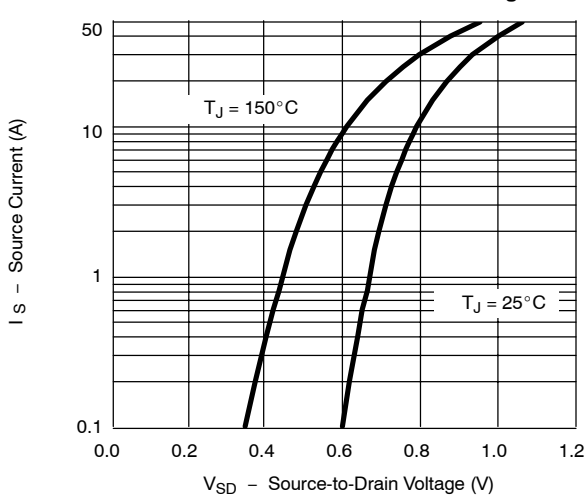

On-Resistance vs. Gate-to-Source Voltage

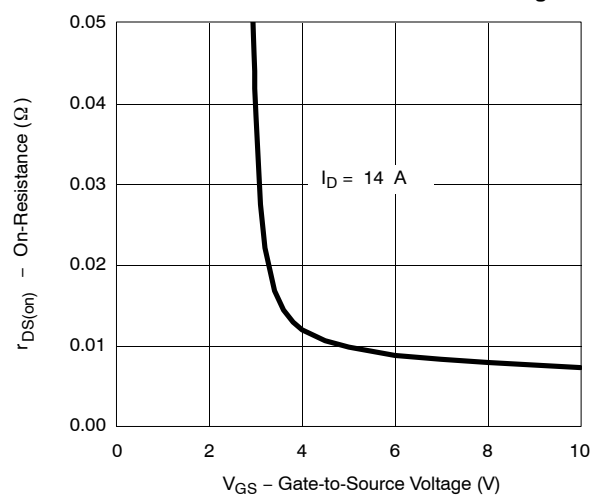

TYPICAL CHARACTERISTICS (25 °C UNLESS NOTED)

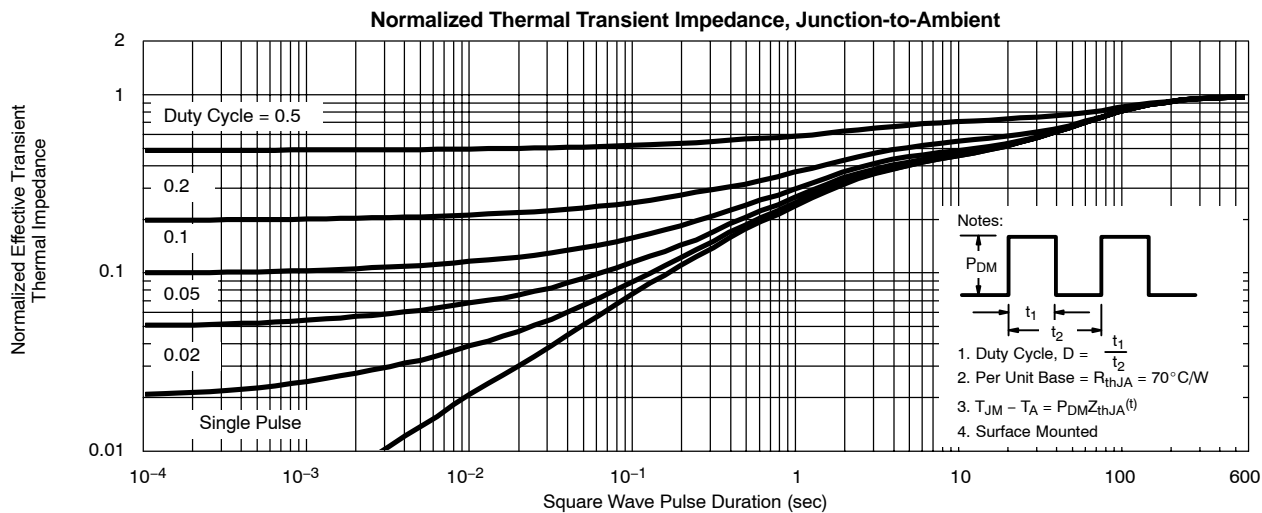
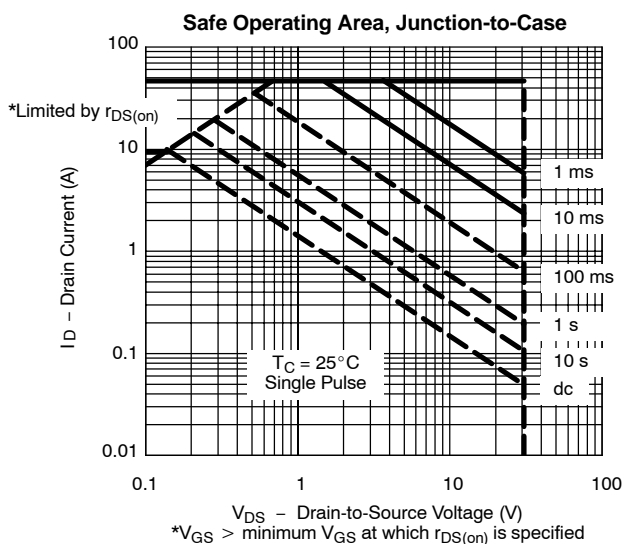
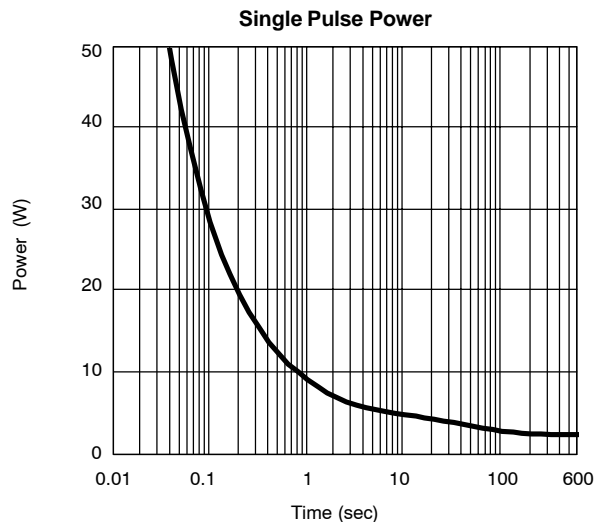
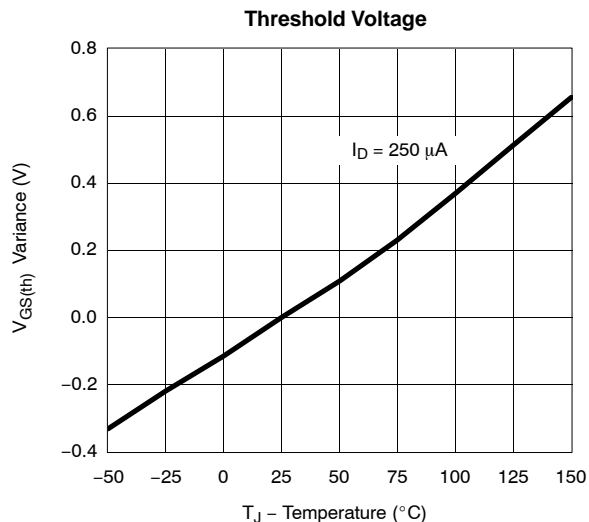



TYPICAL CHARACTERISTICS (25 °C UNLESS NOTED)

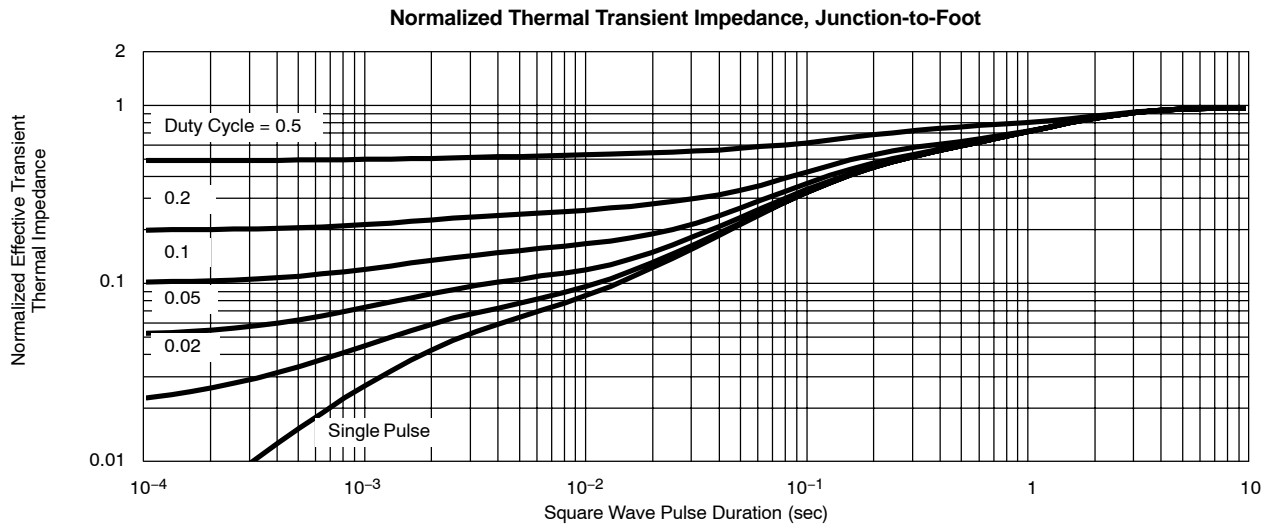

Vishay Siliconix maintains worldwide manufacturing capability. Products may be manufactured at one of several qualified locations. Reliability data for Silicon Technology and Package Reliability represent a composite of all qualified locations. For related documents such as package/tape drawings, part marking, and reliability data, see <http://www.vishay.com/ppg?72862>.