

SK32 THRU SK36

VOLTAGE 20V ~ 60V

3.0AMP Surface Mount Schottky Barrier Rectifiers

FEATURES

- * For surface mount applications
- * Epitaxial construction
- * Very low forward voltage drop
- * For use in low voltage, high frequency inverter, free wheeling

DO- 214AB

SMC



MECHANICAL DATA

- * Case: Molded plastic
- * Epoxy: UL 94V- 0 rate flame retardant
- * Polarity: Color band denotes cathode end
- * Weight: 0.25 grams

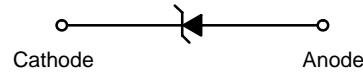

MAXIMUM RATINGS AND ELECTRICAL CHARACTERISTICS

Rating 25°C ambient temperature unless otherwise specified.
Single phase half wave, 60Hz, resistive or inductive load.
For capacitive load, derate current by 20%.

TYPE NUMBER	SK32	SK33	SK34	SK35	SK36	UNITS
Maximum Repetitive Peak Reverse Voltage	20	30	40	50	60	V
Maximum RMS Voltage	14	21	28	35	42	V
Maximum DC Blocking Voltage	20	30	40	50	60	V
Maximum Average Forward Rectified Current See Fig. 1	3.0					A
Peak Forward Surge Current, 8.3 ms single half sine- wave superimposed on rated load (JEDEC method)	100					A
Maximum Instantaneous Forward Voltage at 3.0A	0.50		0.70			V
Maximum DC Reverse Current Ta=25 C	0.5					mA
at Rated DC Blocking Voltage Ta=100 C	20					mA
Typical Junction Capacitance (Note1)	250					pF
Typical Thermal Resistance RJA (Note 2)	50					°C/W
Operating Temperature Range Tj	- 55 — +125					°C
Storage Temperature Range Tstg	- 55 — +150					°C

NOTES

1. Measured at 1MHz and applied reverse voltage of 4.0V D.C.
2. Thermal Resistance Junction to Ambient.

RATING AND CHARACTERISTIC CURVES (SK32 THRU SK36)

FIG.1-TYPICAL FORWARD CURRENT DERATING CURVE

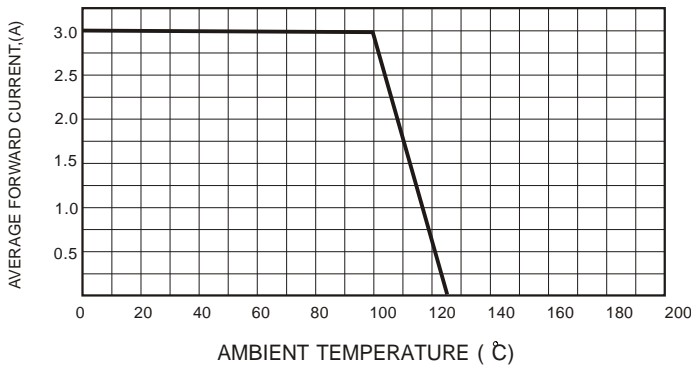

FIG.2-TYPICAL FORWARD CHARACTERISTICS

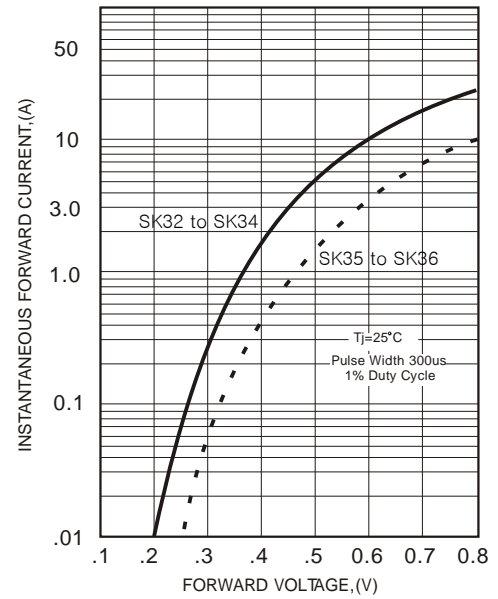

FIG.3-MAXIMUM NON-REPETITIVE FORWARD SURGE CURRENT

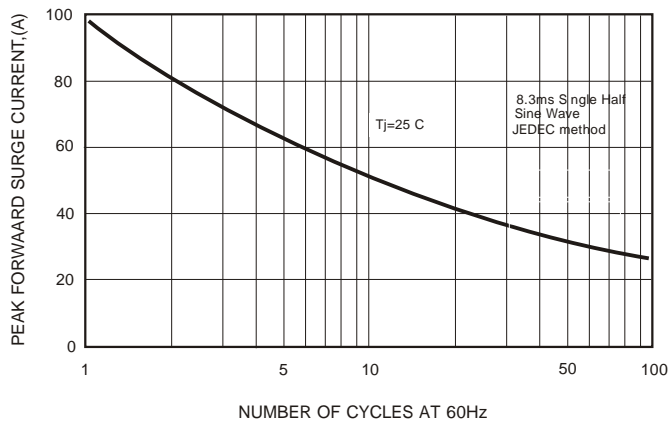

FIG.5 - TYPICAL REVERSE CHARACTERISTICS

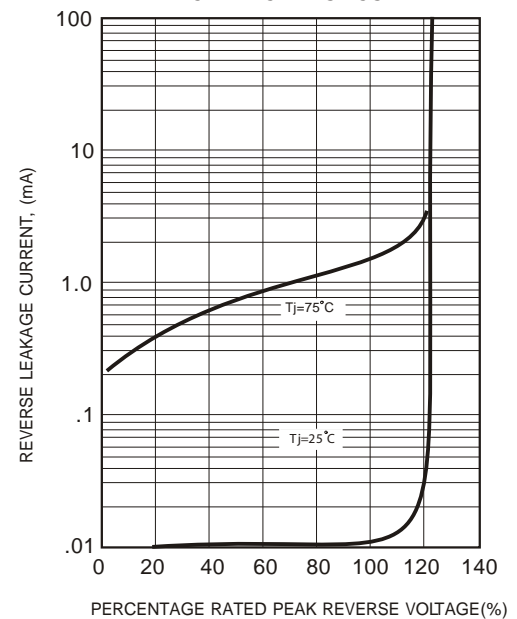
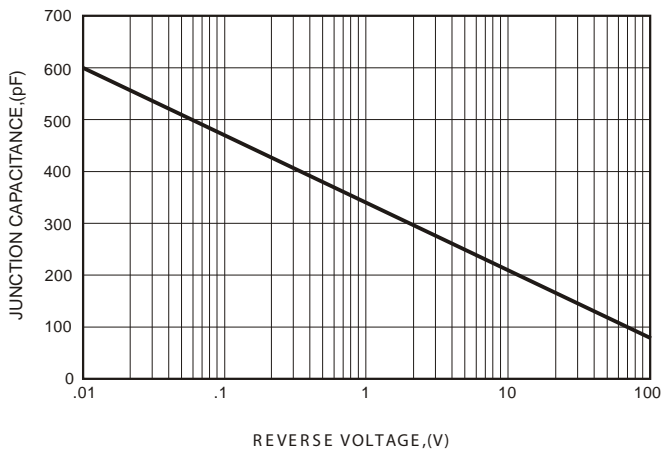
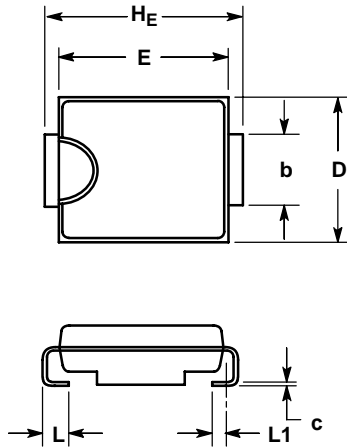

FIG.4-TYPICAL JUNCTION CAPACITANCE



PACKAGE DIMENSIONS

SMC



- NOTES:
1. DIMENSIONING AND TOLERANCING PER ANSI Y14.5M, 1982.
 2. CONTROLLING DIMENSION: INCH.
 3. D DIMENSION SHALL BE MEASURED WITHIN DIMENSION P.
 4. 403-01 THRU -02 OBSOLETE, NEW STANDARD 403-03.

DIM	MILLIMETERS			INCHES		
	MIN	NOM	MAX	MIN	NOM	MAX
A	2.00	2.31	2.62	0.079	0.086	0.103
A1	0.05	0.10	0.15	0.002	0.004	0.006
b	2.92	3.00	3.07	0.115	0.118	0.121
c	0.15	0.23	0.30	0.006	0.009	0.012
D	5.59	5.90	6.22	0.220	0.230	0.240
E	6.60	6.86	7.11	0.260	0.270	0.280
HE	7.75	7.94	8.13	0.305	0.313	0.320
L	0.76	1.14	1.52	0.030	0.040	0.050
L1	0.51 REF			0.020 REF		

SOLDERING FOOTPRINT*

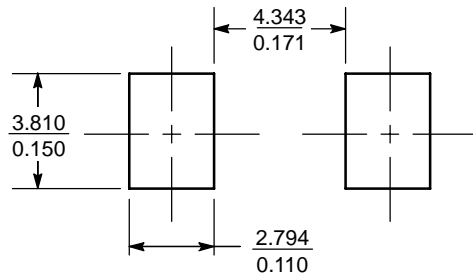

SCALE 4:1 $\left(\frac{\text{mm}}{\text{inches}} \right)$