



SL1045 THRU SL10200

Reverse Voltage - 45 to 200 Volts Forward Current -10.0 Ampere

SURFACE MOUNT SCHOTTKY BARRIER RECTIFIER

Features

- ◆ Schottky Barrier Chip
- ◆ High Thermal Reliability
- ◆ Patented Super Barrier Rectifier Technology
- ◆ High Forward Surge Capability
- ◆ Ultra Fow Power Loss,High Efficiency
- ◆ Excellent High temperature Stability
- ◆ Plastic material-UL flammability 94V-0

TO-277

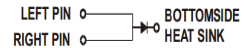
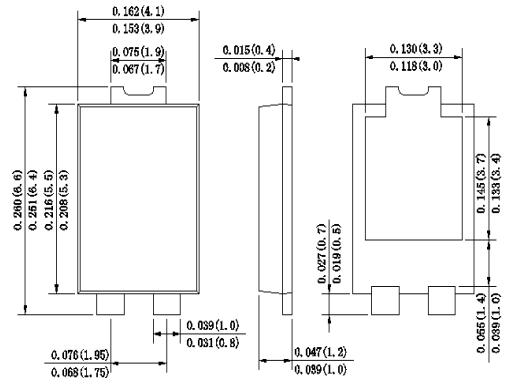

Dimensions in inches and (millimeters)

Mechanical Data

Case : JEDEC TO-277 Molded plastic body
Terminals :Plated Leads Solderable per MIL-STD-202,Method 208
Polarity : Polarity symbol marking on body
Mounting Position : Any
Weight : 0.003 ounce, 0.092 grams

Maximum Ratings And Electrical Characteristics

Ratings at 25°C ambient temperature unless otherwise specified.

Single phase half-wave 60Hz,resistive or inductive load,for capacitive load current derate by 20%.

Parameter	SYMBOLS	SL 1045	SL 1050	SL 1060	SL 1080	SL 10100	SL 10150	SL 10200	UNIT
		MDD SL 1045	MDD SL 1050	MDD SL 1060	MDD SL 1080	MDD SL 10100	MDD SL 10150	MDD SL 10200	
Maximum repetitive peak reverse voltage	V_{RRM}	45	50	60	80	100	150	200	V
Maximum working peak reverse voltage	V_{RWM}								
Maximum DC blocking voltage	V_{DC}								
RMS Reverse voltage	V_{RMS}	32	35	42	56	70	105	140	V
Average Rectified Output Current	$I_{(O)}$	10							A
Non-Repetitive Peak Forward Surge 8.3ms Single Half Sine-Wave Superimposed on rated load(JEDEC Method)	I_{FSM}	250							A
Forward Voltage Drop at 10.0A $T_A=25^\circ C$	V_F	0.45	0.50	0.75		0.78		V	
Peak reverse curent at rated DC blocking voltage $T_A=25^\circ C$ $T_A=125^\circ C$	I_R	0.3							mA
		15							
Typical thermal resistance Junctionto Ambient	$R_{\theta JA}$ $R_{\theta JL}$	80							°C/W
		15							
Operating junction and storage temperature range	T_J, T_{STG}	-55 to +150							°C

Note:1.The typical data above is for referenceonly.



SL1045 THRU SL10200

Reverse Voltage - 45 to 200 Volts Forward Current -10.0 Ampere

Ratings And Characteristic Curves

Fig.1 - Forward Current Derating Curve

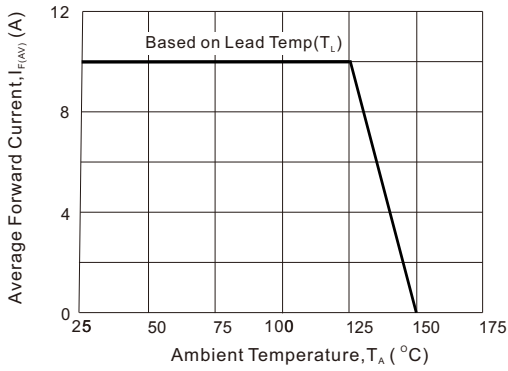

Fig2 : Instantaneous Forward Voltage

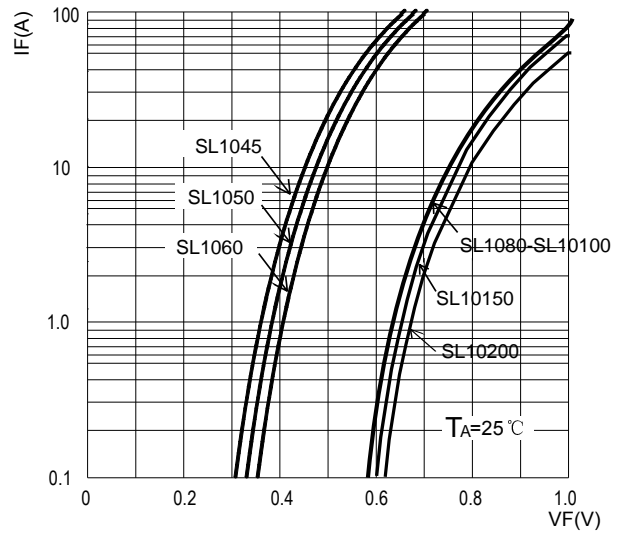

Fig3: Surge Forward Current Capadility

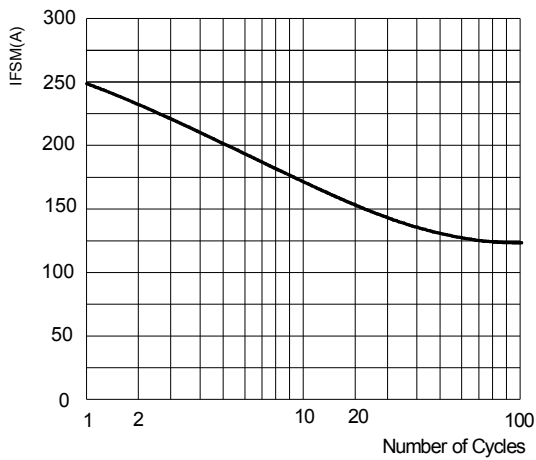
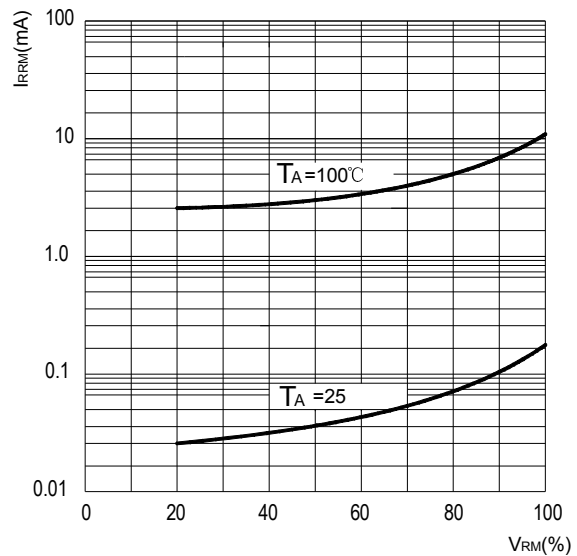

Fig4: Typical Reverse Characteristics



The curve above is for reference only.



SL1045 THRU SL10200

Reverse Voltage - 45 to 200 Volts Forward Current -10.0 Ampere

Packing information

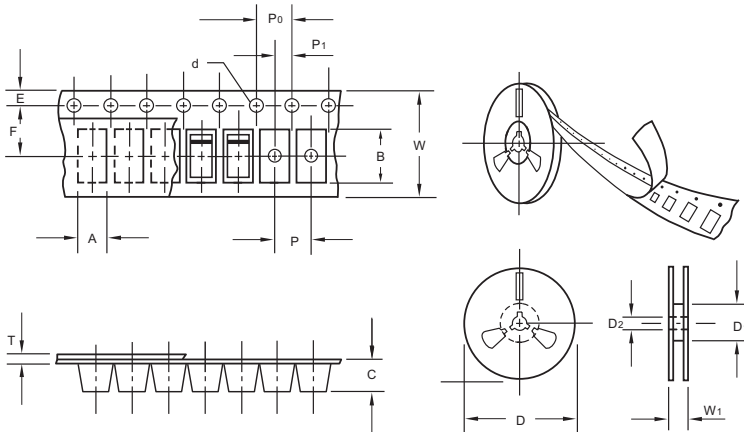

unit:mm

Item	Symbol	Tolerance	TO-277
Carrier width	A	0.1	4.45
Carrier length	B	0.1	7.0
Carrier depth	C	0.1	1.60
Sprocket hole	d	0.05	1.55
13" Reel outside diameter	D	2.0	330.00
13" Reel inner diameter	D1	min	50.0
Feed hole diameter	D2	0.5	13.00
Sprocket hole position	E	0.1	1.75
Punch hole position	F	0.1	7.50
Punch hole pitch	P	0.1	8.00
Sprocket hole pitch	P0	0.1	4.00
Embossment center	P1	0.1	2.00
Overall tape thickness	T	0.1	0.25
Tape width	W	0.3	12.00
Reel width	W1	1.0	12.30

Note: Devices are packed in accordance with EIA standard RS-481-A and specifications listed above.

Reel packing

PACKAGE	REEL SIZE	REEL (pcs)	COMPONENT SPACING (m/m)	BOX (pcs)	INNER BOX (m/m)	REEL DIA, (m/m)	CARTON SIZE (m/m)	CARTON (pcs)	APPROX. GROSS WEIGHT (kg)
TO-277	13"	5,000	4.0	10,000	210*208*203	330	430*430*235	80,000	13.0

Suggested Pad Layout

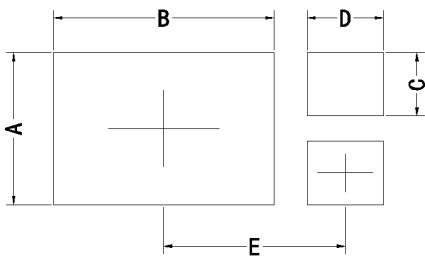

Symbol	Unit (mm)	Unit (inch)
A	3.60	0.142
B	5.35	0.211
C	1.50	0.059
D	1.85	0.073
E	4.30	0.169

Important Notice and Disclaimer

Microdiode Electronics (Jiangsu) reserves the right to make changes to this document and its products and specifications at any time without notice. Customers should obtain and confirm the latest product information and specifications before final design, purchase or use.

Microdiode Electronics (Jiangsu) makes no warranty, representation or guarantee regarding the suitability of its products for any particular purpose, nor does Microdiode Electronics (Jiangsu) assume any liability for application assistance or customer product design. Microdiode Electronics (Jiangsu) does not warrant or accept any liability with products which are purchased or used for any unintended or unauthorized application.

No license is granted by implication or otherwise under any intellectual property rights of Microdiode Electronics (Jiangsu).

Microdiode Electronics (Jiangsu) products are not authorized for use as critical components in life support devices or systems without express written approval of Microdiode Electronics (Jiangsu).