

500 WATT ULTRA LOW CAPACITANCE TVS ARRAY



DESCRIPTION

The SLVU2.8-8G is an ultra low capacitance TVS array, designed to protect four line pairs from the effects of Electrostatic Discharge (ESD), Electrical Fast Transients (EFT) and switching transients. The SLVU2.8-8G exceeds Level 4 IEC 61000-4-2, with a peak pulse power rating of 500 Watts for an 8/20 μ s waveshape.

The ultra low capacitance and low leakage current of the device allows the designer to protect high speed data applications. Packaged in a SO-8 configuration, the SLVU2.8-8G is both RoHS and REACH compliant.

FEATURES

- IEC Compatibility IEC 61000-4-2 (ESD): Air - 15kV, Contact - 8kV
- IEC Compatibility IEC 61000-4-4 (EFT): 40A - 5/50ns
- IEC Compatibility IEC 61000-4-5 (Surge): 24A, 8/20 μ s - Level 2 (Line-Gnd) & Level 3 (Line-Line)
- 500 Watts Peak Pulse Power per Line ($t_p = 8/20\mu$ s)
- Provides Protection for Four Line Pairs
- Low Leakage Current < 1.0 μ A
- Ultra Low Capacitance: 6.2pF Max
- RoHS Compliant
- REACH Compliant

APPLICATIONS

- Ethernet - 10/100/1000 Base T
- Cellular Phones
- Audio/Video Inputs
- Handheld Electronics
- SMART Phones

MECHANICAL CHARACTERISTICS

- Molded JEDEC SO-8 Package
- Approximate Weight: 70 milligrams
- Lead-Free Pure-Tin Plating (Annealed)
- Solder Reflow Temperature:
Pure-Tin - Sn, 100: 260-270°C
- 8mm Tape and Reel Per EIA Standard 481
- Flammability Rating UL 94V-0

PIN CONFIGURATION

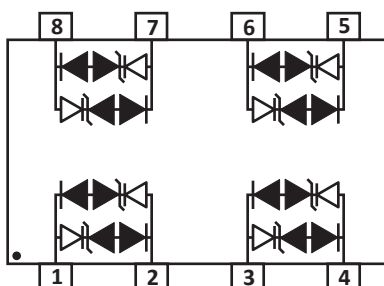

TYPICAL DEVICE CHARACTERISTICS
MAXIMUM RATINGS @ 25°C Unless Otherwise Specified

PARAMETER	SYMBOL	VALUE	UNITS
Peak Pulse Power (tp = 8/20μs) - See Figure 1	P_{PP}	500	Watts
Peak Pulse Current (tp = 8/20μs)	I_{PP}	30	Amps
Operating Temperature	T_L	-55 to 150	°C
Storage Temperature	T_{STG}	-55 to 150	°C

ELECTRICAL CHARACTERISTICS PER LINE @ 25°C Unless Otherwise Specified

PART NUMBER	DEVICE MARKING	RATED STAND-OFF VOLTAGE (Note 1)	MINIMUM BREAKDOWN VOLTAGE (Note 1)	MAXIMUM SNAPBACK VOLTAGE (Note 1)	MAXIMUM CLAMPING VOLTAGE (Note 1) (Fig. 2)				MAXIMUM LEAKAGE CURRENT (Note 1)	MAXIMUM CAPACITANCE (Note 1)
					@ $I_{PP} = 2A$	@ $I_{PP} = 5A$	@ $I_{PP} = 24A$	@ $I_{PP} = 30A$		
		V_{WM} VOLTS	@ 1mA $V_{(BR)}$ VOLTS	@ $I_{SB} = 50mA$ V_{SB} VOLTS	V_C VOLTS	V_C VOLTS	V_C VOLTS	V_C VOLTS	@ V_{WM} I_D μA	0V, 1MHz C pF
SLVU2.8-8G	288G	2.8	3.0	2.8	5.5	8.5	15	17	1.0	6.2

NOTES

1. Device is measured between pin 1 to 2, pin 3 to 4, pin 5 to 6 and pin 7 to 8.

TYPICAL DEVICE CHARACTERISTICS

FIGURE 1
PEAK PULSE POWER VS PULSE TIME

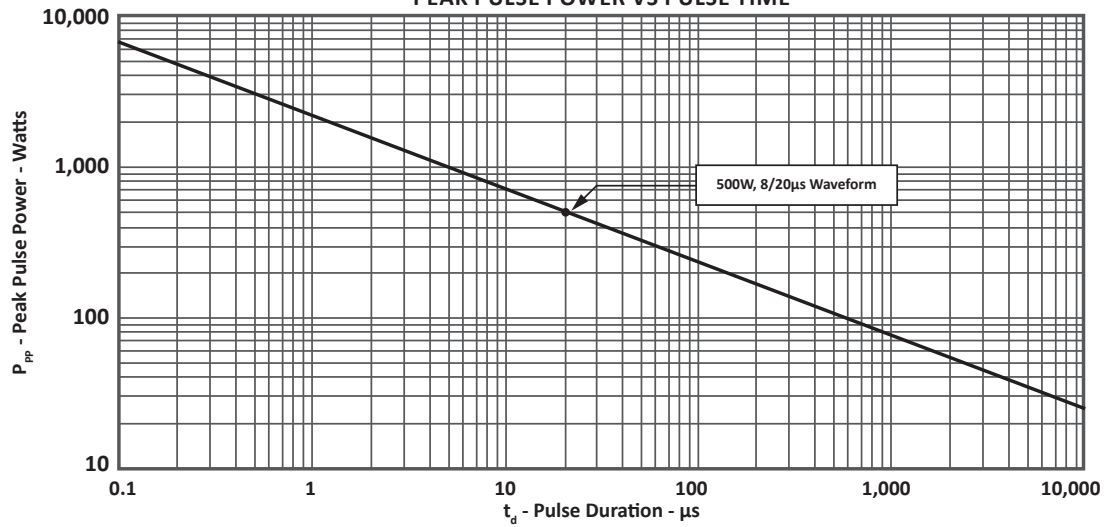
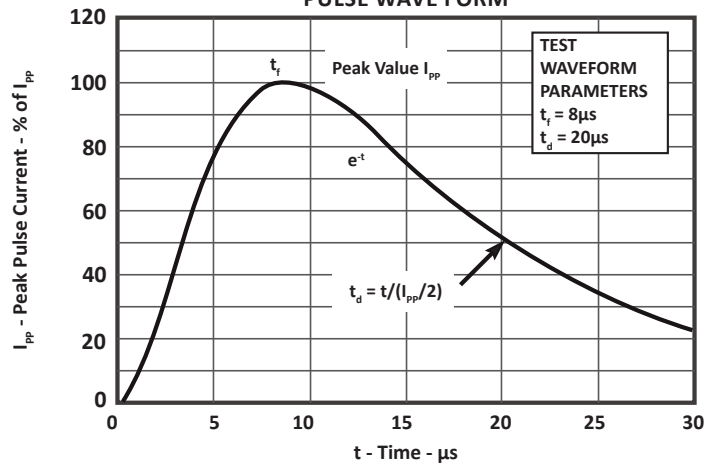
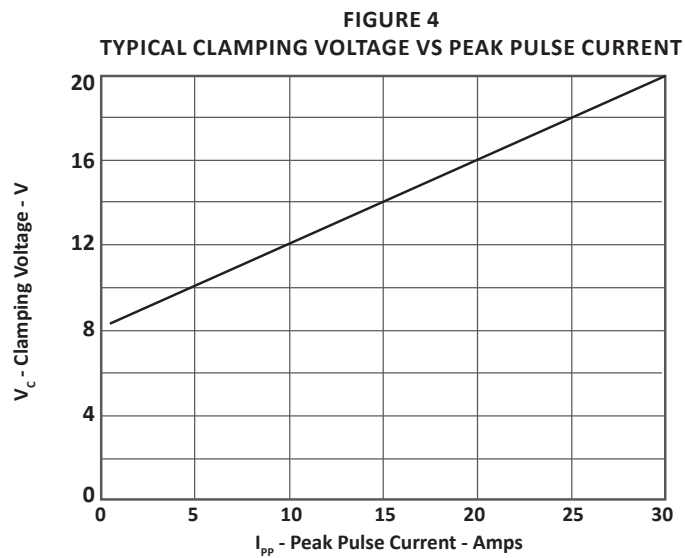
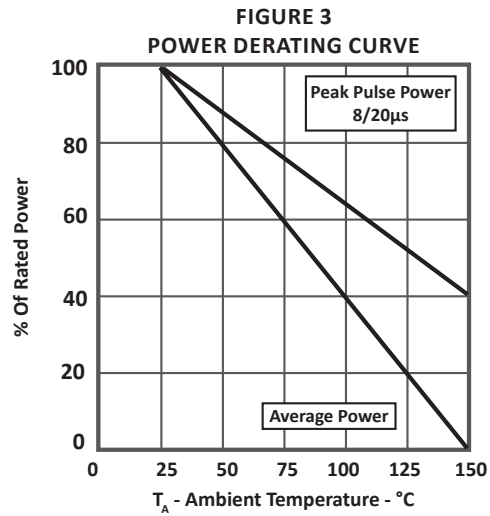

FIGURE 2
PULSE WAVE FORM



TYPICAL DEVICE CHARACTERISTICS



APPLICATION INFORMATION

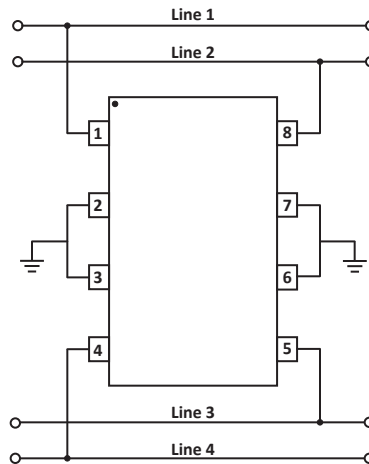

FIGURE 1 - BIDIRECTIONAL COMMON-MODE PROTECTION

The SLVU2.8-8G provides 4 lines of protection in a common mode configuration. Circuit connectivity is as follows:

- Line 1 connected to Pin 1
- Line 2 connected to Pin 8
- Line 3 connected to Pin 5
- Line 4 connected to Pin 4
- Pins 2, 3, 6, 7 are connected to ground

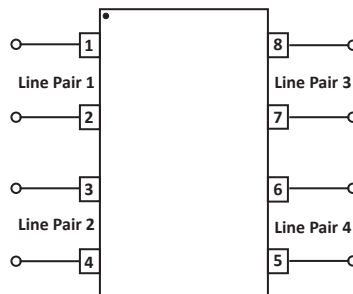

FIGURE 2 - BIDIRECTIONAL DIFFERENTIAL-MODE PROTECTION

The SLVU2.8-8G provides four line pairs in a differential mode configuration. Circuit connectivity is as follows:

- Line Pair 1 connected to Pins 1 & 2
- Line Pair 2 connected to Pins 3 & 4
- Line Pair 3 connected to Pins 5 & 6
- Line Pair 4 connected to Pins 7 & 8

CIRCUIT BOARD RECOMMENDATIONS

Circuit board layout is critical for electromagnetic compatibility protection. The following guidelines are recommended:

- The protection device should be placed near the input terminals or connectors, the device will divert the transient current immediately before it can be coupled into the nearby traces.
- The path length between the TVS device and the protected line should be minimized.
- All conductive loops including power and ground loops should be minimized.
- The transient current return path to ground should be kept as short as possible to reduce parasitic inductance.
- Ground planes should be used whenever possible. For multilayer PCBs, use ground vias.

SO-8 PACKAGE INFORMATION

OUTLINE DIMENSIONS

DIM	MILLIMETERS		INCHES	
	MIN	MAX	MIN	MAX
A	4.80	5.00	0.189	0.196
B	3.80	4.00	0.150	0.157
C	1.35	1.75	0.054	0.068
D	0.35	0.49	0.014	0.019
F	0.40	1.25	0.016	0.049
G	1.27 BSC		0.05 BSC	
J	0.18	0.25	0.007	0.009
K	0.10	0.25	0.004	0.008
P	5.80	6.20	0.229	0.244
R	0.25	0.50	0.010	0.019

NOTES

- T = Seating plane and datum surface.
- Dimensions "A" and "B" are datum.
- Dimensions "A" and "B" do not include mold protrusion.
- Maximum mold protrusion is 0.015" (0.380mm) per side.
- Dimensioning and tolerances per ANSI Y14.5M, 1982.
- Dimensions are exclusive of mold flash and metal burrs.

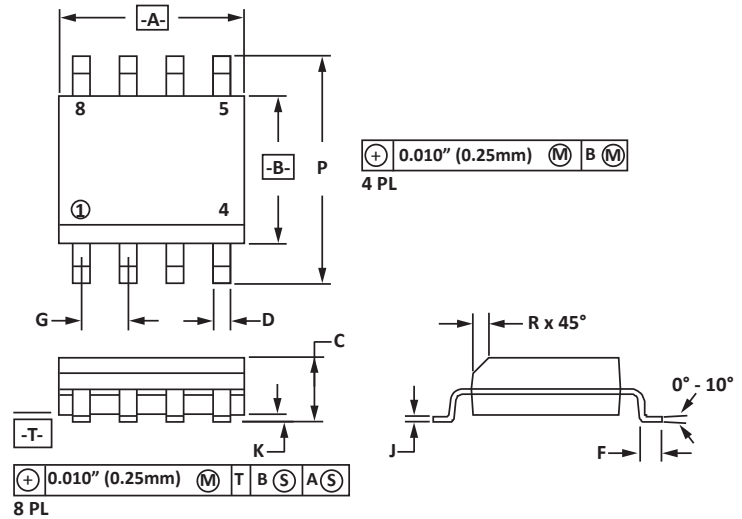

PAD LAYOUT DIMENSIONS

DIM	MILLIMETERS		INCHES	
	MIN	MAX	MIN	MAX
A	1.14	1.40	0.045	0.055
B	0.64	0.89	0.025	0.035
C	6.22	-	0.245	-
D	3.94	4.17	0.155	0.165
E	1.02	1.27	0.040	0.050

NOTES

- Controlling dimension: inches.

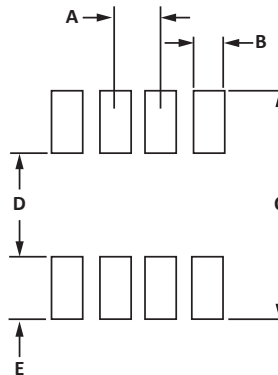

TAPE AND REEL

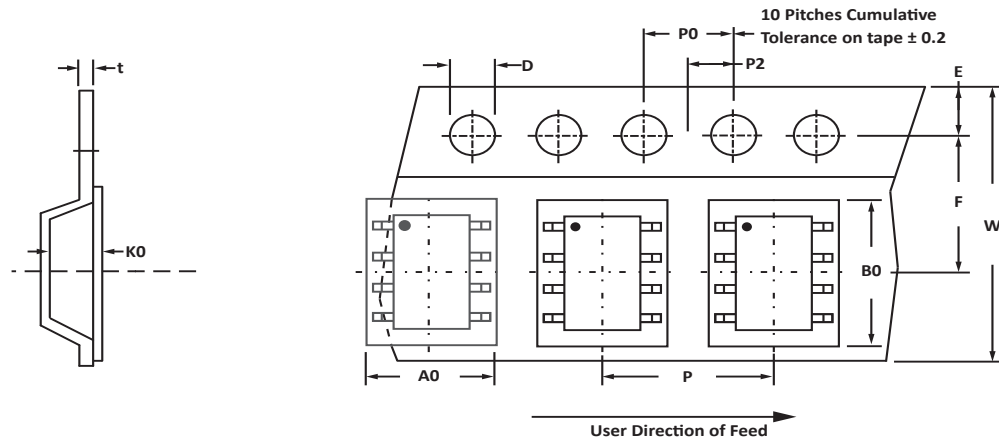

SPECIFICATIONS

REEL DIA.	TAPE WIDTH	A0	B0	K0	D	E	F	W	P0	P2	P	tmax
178mm (7")	12mm	6.50 ± 0.10	5.40 ± 0.10	2.00 ± 0.10	1.50 ± 0.10	1.75 ± 0.10	5.50 ± 0.05	12.00 ± 0.30	4.00 ± 0.12	2.00 ± 0.10	4.00 ± 0.10	0.25

NOTES

- Dimensions are in millimeters.
- Surface mount product is taped and reeled in accordance with EIA-481.
- Suffix - T7 = 7" Reel - 1,000 pieces per 12mm tape.
- Suffix - T13 = 13" Reel - 2,500 pieces per 12mm tape.
- Bulk product shipped in tubes of 98 pieces per tube.
- Marking on Part - marking code (see page 2), date code, logo and pin one defined by dot on top of package.

Package outline, pad layout and tape specifications per document number 06009.R3 9/10.

ORDERING INFORMATION

BASE PART NUMBER	LEADFREE SUFFIX	TAPE SUFFIX	QTY/REEL	REEL SIZE	TUBE QTY
SLVU2.8-8G	n/a	-T7	1,000	7"	98
SLVU2.8-8G	n/a	-T13	2,500	13"	98

This device is only available in a Lead-Free configuration.

COMPANY INFORMATION

COMPANY PROFILE

ProTek Devices, based in Tempe, Arizona USA, is a manufacturer of Transient Voltage Suppression (TVS) products designed specifically for the protection of electronic systems from the effects of lightning, Electrostatic Discharge (ESD), Nuclear Electromagnetic Pulse (NEMP), inductive switching and EMI/RFI. With over 25 years of engineering and manufacturing experience, ProTek designs TVS devices that provide application specific protection solutions for all electronic equipment/systems.

ProTek Devices Analog Products Division, also manufactures analog interface, control, RF and power management products.

CONTACT US

Corporate Headquarters

2929 South Fair Lane
Tempe, Arizona 85282
USA

By Telephone

General: 602-431-8101
Sales: 602-414-5109
Customer Service: 602-414-5114

By Fax

General: 602-431-2288

By E-mail:

Sales: sales@protekdevices.com
Customer Service: service@protekdevices.com
Technical Support: support@protekdevices.com

Web

www.protekdevices.com
www.protekanalog.com

COPYRIGHT © ProTek Devices 2012 - This literature is subject to all applicable copyright laws and is not for resale in any manner.

SPECIFICATIONS: ProTek reserves the right to change the electrical and or mechanical characteristics described herein without notice.

DESIGN CHANGES: ProTek reserves the right to discontinue product lines without notice and that the final judgement concerning selection and specifications is the buyer's and that in furnishing engineering and technical assistance. ProTek assumes no responsibility with respect to the selection or specifications of such products. ProTek makes no warranty, representation or guarantee regarding the suitability of its products for any particular purpose, nor does ProTek assume any liability arising out of the application or use of any product or circuit and specifically disclaims any and all liability without limitation special, consequential or incidental damages.

LIFE SUPPORT POLICY: ProTek Devices products are not authorized for use in life support systems without written consent from the factory.