

SM120A-E thru SM1100A-E

Schottky Barrier Rectifiers Reverse Voltage 20 to 100V Forward Current 1.0A

FEATURES

- * Plastic package has Underwriters Laboratory Flammability Classification 94V-0
- * Low power loss, high efficiency
- * For use in low voltage high frequency inverters, free wheeling, and polarity protection applications
- * Guardring for over voltage protection
- * High temperature soldering guaranteed: 260°C/10 seconds at terminals
- * IEC61000-4-2 ESD Air Contact $\geq \pm 15\text{KV}$

Mechanical Data

Case: JEDEC DO-214AC,

molded plastic over sky die

Terminals: Plated axial leads, solderable per MIL-STD-750, Method 2026

Polarity: Color band denotes cathode end

Mounting Position: Any

Weight: 0.0023 oz., 0.065 g

Handling precaution: None



We declare that the material of product compliance with ROHS requirements

1. Electrical Characteristic

Maximum & Thermal Characteristics Ratings at 25°C ambient temperature unless otherwise specified.

Parameter Symbol	symbol	SM120A-E	SM130A-E	SM140A-E	SM150A-E	SM160A-E	SM180A-E	SM1100A-E	Unit
device marking code		S12●	S13●	S14●	S15●	S16●	S18●	S110●	
Maximum repetitive peak reverse voltage	VRRM	20	30	40	50	60	80	100	V
Maximum RMS voltage	VRMS	14	21	28	35	42	56	70	V
Maximum DC blocking voltage	VDC	20	30	40	50	60	80	100	V
Maximum average forward rectified current at TA = 75°C	IF(AV)	1.0							A
Peak forward surge current 8.3ms single half sine-wave superimposed on rated load (JEDEC Method)	IFSM	30							A
Typical thermal resistance (Note 1)	RθJA	50							°C/W
Operating junction and storage temperature range	TJ, TSTG	-40 to +150							°C

Electrical Characteristics Ratings at 25°C ambient temperature unless otherwise specified.

Parameter Symbol	symbol	SM120A-E	SM130A-E	SM140A-E	SM150A-E	SM160A-E	SM180A-E	SM1100A-E	Unit	
Maximum instantaneous forward voltage at 1.0A	V _F	0.50			0.70		0.85		V	
Maximum DC reverse current TA = 25°C at rated DC blocking voltage Tj = 125°C	IR	0.5				5.0				mA
Typical junction capacitance at 4.0V, 1MHz	CJ	110							PF	

NOTES:

1. 8.0mm² (.013mm thick) land areas

SM120A-E thru SM1100A-E

2. Ratings and Characteristic Curves (TA = 25°C unless otherwise noted)

Fig. 1 - Forward Current Derating Curve

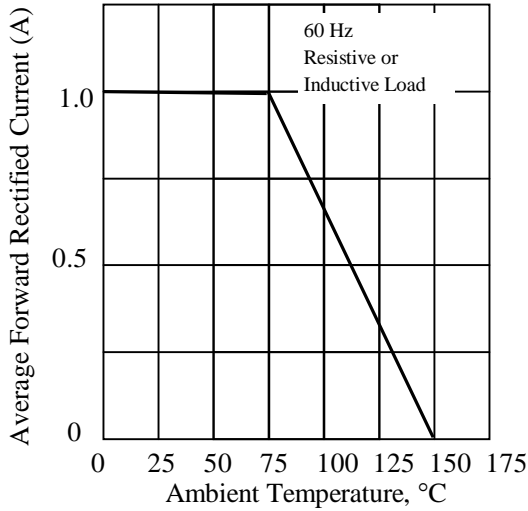

Fig. 2 - Maximum Non-repetitive Peak Forward Surge Current

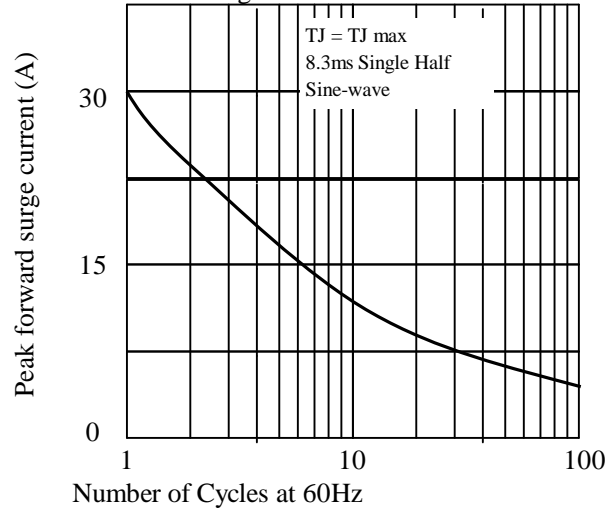

Fig 3. - Typical Instantaneous Forward Characteristics

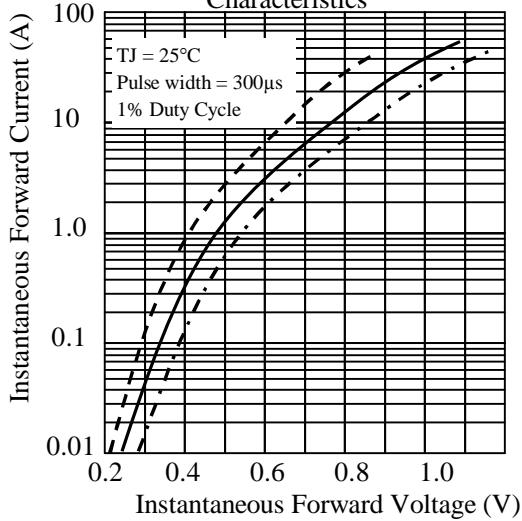

Fig 4. - Typical Reverse Characteristics

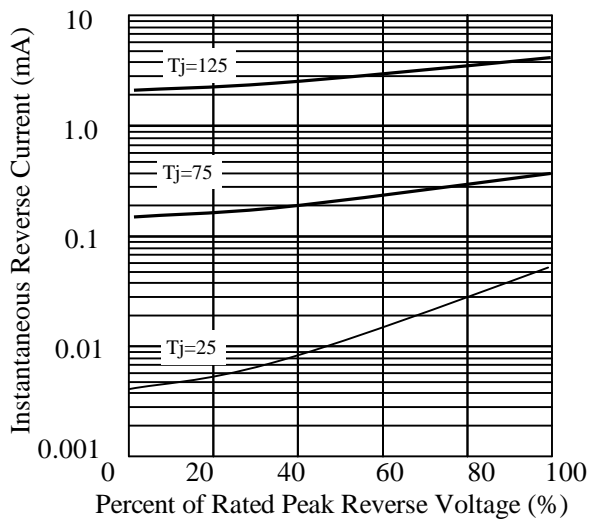

Fig 5. - typical transient thermal impedance

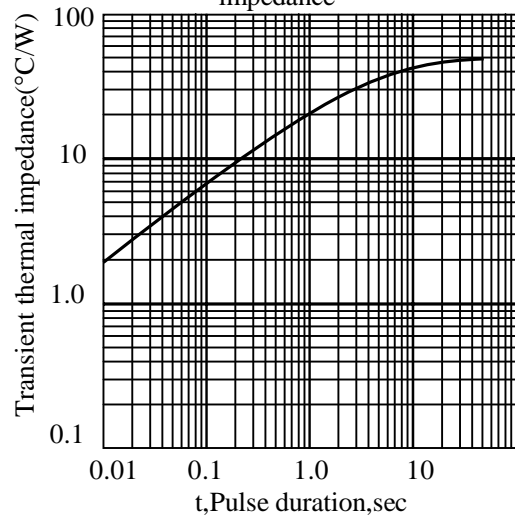
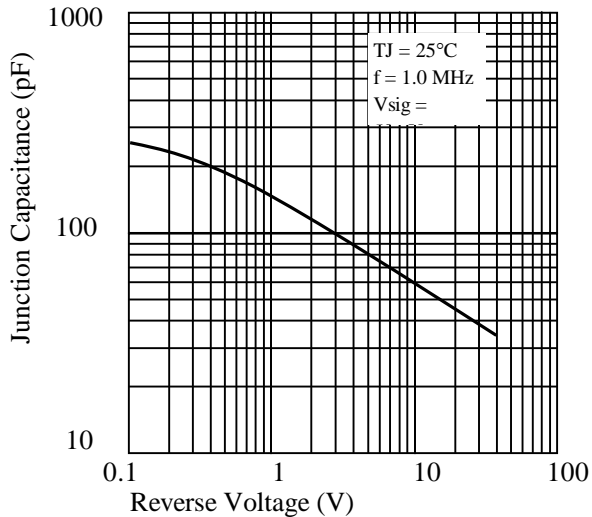
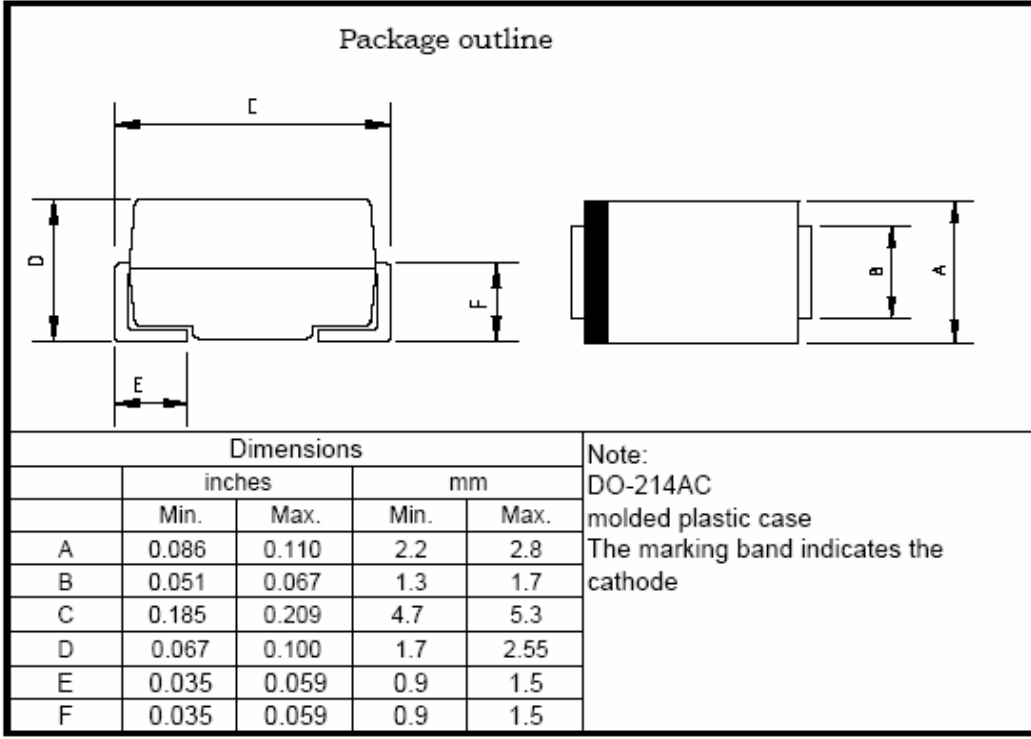

Fig 6. - Typical Junction Capacitance



SM120A-E thru SM1100A-E

3. dimension:



Mounting Pad Layout ---SMA

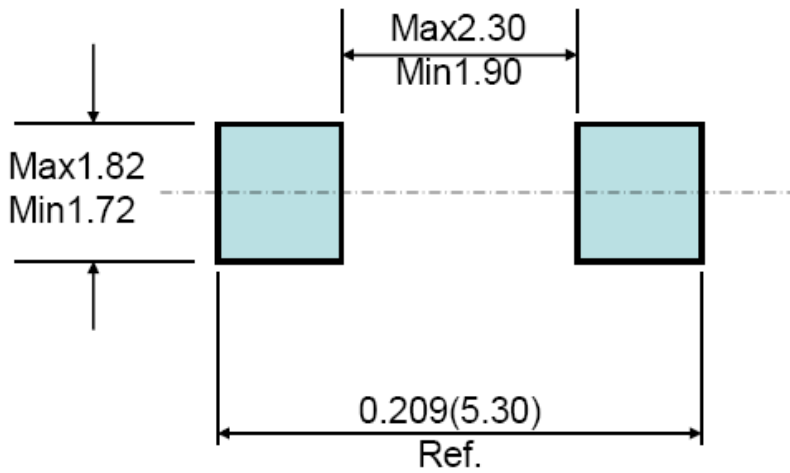

SM140A-E: "S"--肖特基产品; "M"--表面贴装; "1"--正向电流1A; "40"--VB为40V; "A"--SMA封装;
"E"--满足ESD大于15KV.

标题Title: 塑封生产线SMD产品包装规范 Packaging specification of SMD	文件编号: WI-258
	第 3 版 第 0 次修改
	第 2 页

SMD产品通用包装材料规格以及包装产品数量
General packaging materials spec. and quantity

1.1 卷装 reel

A. 卷盘规格 reel spec

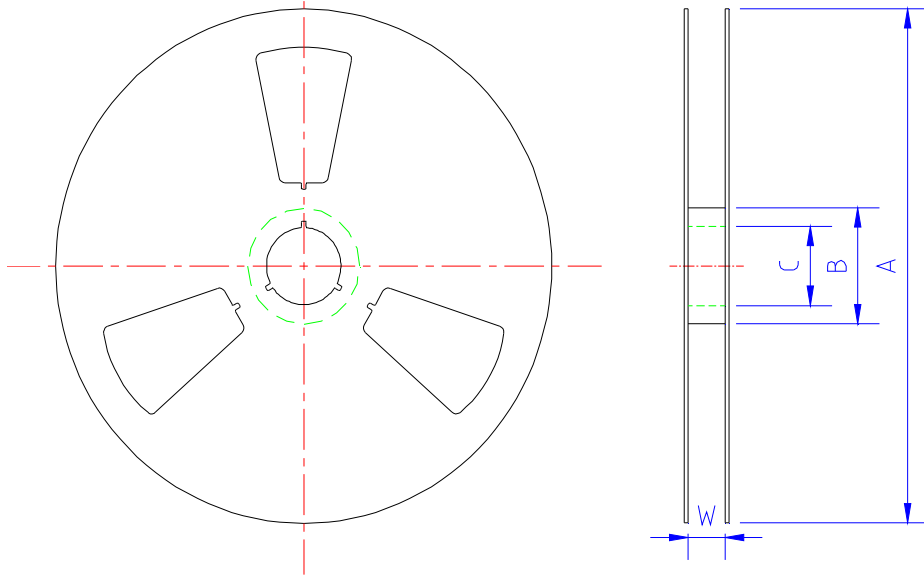

单位: mm

规格	A	B	C	W	每卷数量
SMA 7"卷盘	177.0±2.0	54.0±0.5	13.0±0.5	13.2±0.2	2K
SMA13"卷盘	330.0±2.0	75.0±0.5	13.0±0.5	13.2±0.2	5K
SMB13"卷盘	330.0±2.0	75.0±0.5	13.0±0.5	13.5±0.5	3K
SMC13"卷盘	330.0±2.0	75.0±0.5	13.0±0.5	17.0±0.5	3K

B. 13"卷盘内盒 inner box

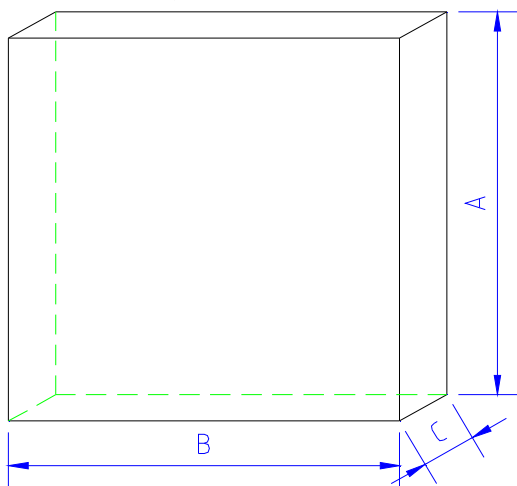

单位: mm

	A	B	C
尺寸	335±5.0	335±2.0	40±1.0

按以上包装方式, 产品包装数量: quantity

规格	每盒数量
SMA13"卷盘	10K
SMB13"卷盘	6K
SMC13"卷盘	6K

标题Title: 塑封生产线SMD产品包装规范 Packaging specification of SMD	文件编号: WI-258
	文件编号: WI-258
	第 3 页

C. 7"卷盘盒 box

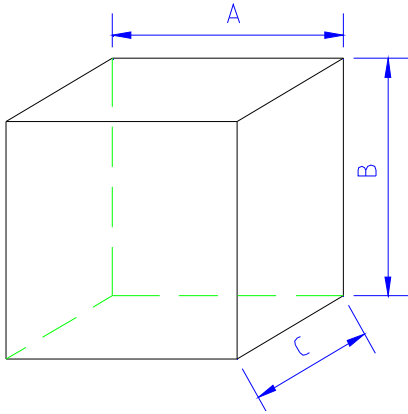

单位: mm

	A	B	C
尺寸	188±2.0	188±2.0	138±2.0

按以上包装方式, 产品包装数量: quantity

	每盒数量
7"卷盘	16K

D. 卷盘外箱 reel carton

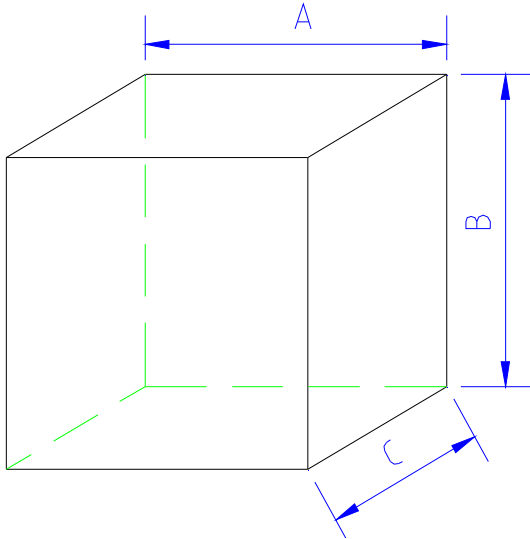

单位: mm

	A	B	C
尺寸	350±2.0	340±2.0	350±2.0

按以上包装方式, 产品包装数量:

规格	每箱数量
SMA 7"卷盘	80K
SMA13"卷盘	80K
SMB13"卷盘	48K
SMC13"卷盘	36K

1.2 编带规格 tape spec

A. 盖带 Cover tape

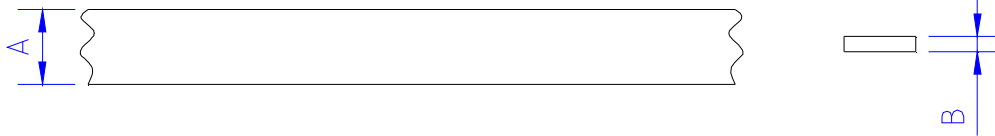

单位: mm

	A	B
SMA	9.30±0.10	0.068±0.005
SMB		
SMC		

标题Title: 塑封生产线SMD产品包装规范 Packaging specification of SMD	文件编号: WI-258
	第 3 版 第 0 次修改
	第 4 页

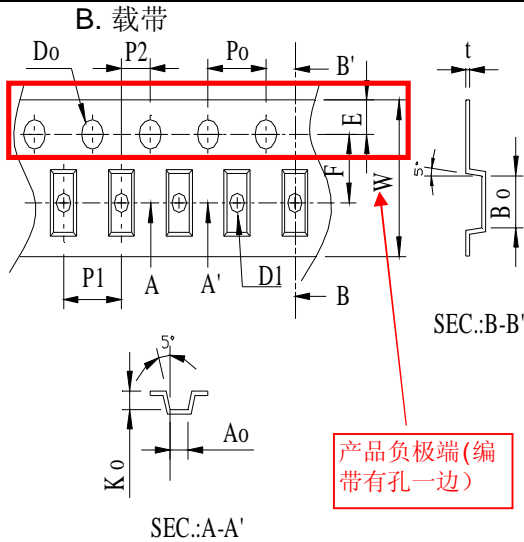

类型	SMA	SMB	SMC
W	12±0.3	12±0.3	16±0.3
P1	4±0.1	8±0.1	8±0.1
E	1.75±0.1	1.75±0.1	1.75±0.1
F	5.5±0.05	5.5±0.05	7.5±0.05
D0	1.55±0.05	1.55±0.05	1.55±0.05
D1	1.5±0.1	1.55±0.05	1.55±0.05
P0	4±0.1	4±0.1	4±0.1
P2	2±0.05	2±0.05	2±0.05
10P0	40±0.2	40±0.2	40±0.2
A0	2.79±0.1	3.8±0.1	6.05±0.1
B0	5.33±0.1	5.4±0.1	8.31±0.1
K0	2.36±0.1	2.45±0.1	2.54±0.1
T	0.25±0.05	0.25±0.05	0.25±0.05

2、SMD产品通用包装规范 General spec of SMD

5.2.1国内客户domestic

A. 7"卷盘reel

所有标签贴在卷盘负极 all the label on cathode side

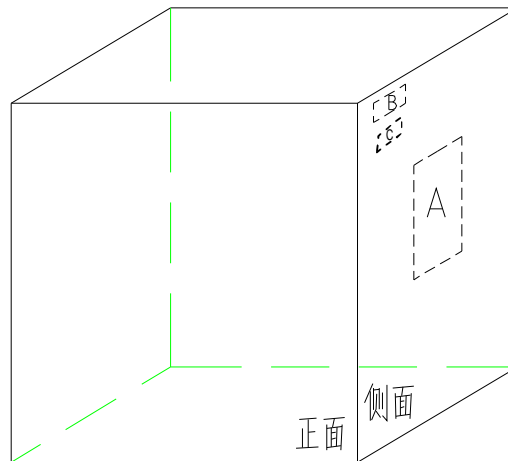
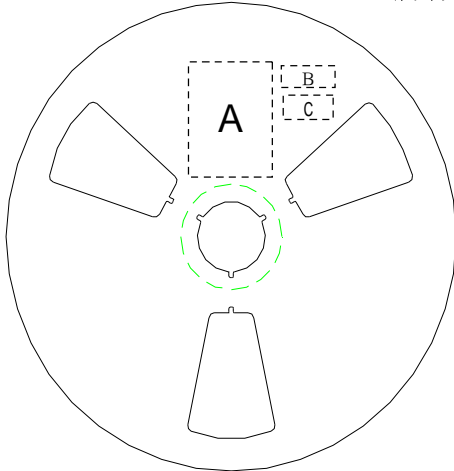

A处:贴LRC标签; B处:贴ROHS标签 C处:贴无卤标签 HF label

B. 13"卷盘 所有标签贴在卷盘负极 all the label (无卤产品才贴HF only)

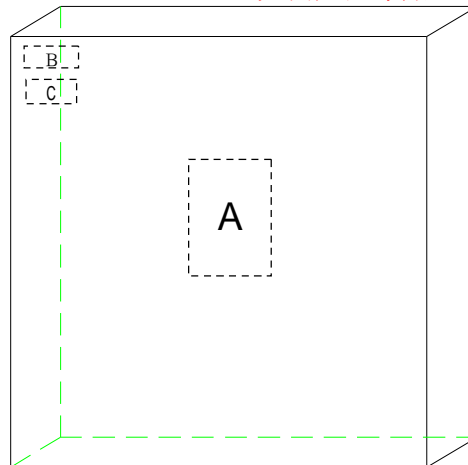
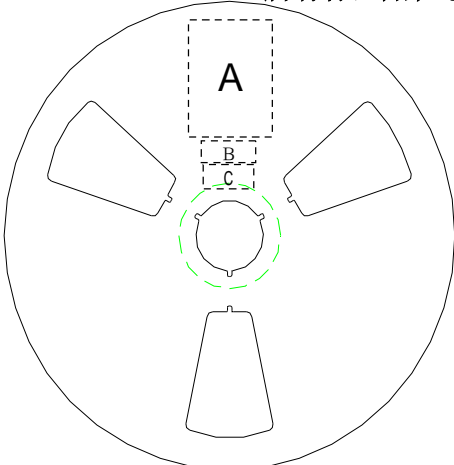

A处:贴LRC标签; B处:贴ROHS标签 C处:贴无卤标签 (无卤产品才贴HF only)

标题Title: 塑封生产线SMD产品包装规范 Packaging specification of SMD	文件编号: WI-258
	第 3 版 第 0 次修改
	第 5 页

C. 标签要求label spec:

LRC标签label

型号 TYPE	*****	← LRC产品型号 type
数量(只) QTY(PCS)	*****	← 产品数量 quantity
批号 LOT	*****	← 产品批号 LOT
日期 DATE	*****	← 产品生产日期 date
检验员: CHECKER		

ROHS标签



无卤标签 HF label



2.2 国外客户
overseas

所有标签贴在卷盘负极 all the label on cathode side

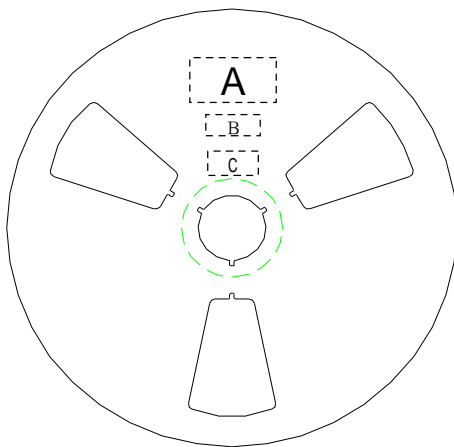

7"卷盘盒 inner box

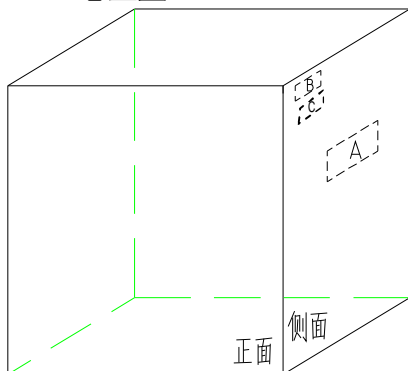

A处:贴LRC标签;

B处:贴ROHS标签

13"卷盘内盒inner box

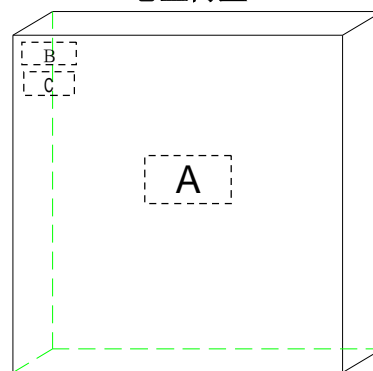

C处:贴无卤标签HF label
(无卤产品才贴HF only)

标题Title: 塑封生产线SMD产品包装规范 Packaging specification of SMD	文件编号: WI-258
	第 3 版 第 0 次修改
	第 6 页

LRC标签label

TYPE:*****	← LRC产品型号
MARK:*****	← 印字型号
Q'TY:*****	← 产品数量
DATE:*****	← 产品生产日期

ROHS标签



无卤标签 HF label



注意事项NOTE:

- 13"卷盘内盒装好产品,需用热缩膜包装;13"reel'inner box must be packed by shrink film
- 所有编带产品卷装完成后,用白色胶带将编带粘牢;
every tape after packing, must be fixed by white adhesive tape

3.1产品出厂检验报告 testing report of the OQC

每批出货时,需要附上出厂检验报告 every lot must with test report

3.2尾箱

同一编码每批次只允许出现一个尾数箱,对于尾数物料,须用缓冲材料对空余部分填充好,保证物料在受到一定的外作用力下不发生明显移动,且物料间无碰撞。

The same coding is only one ending for each batch box materials for the mantissa to be good filled with cushioning material.

SM120A-E thru SM1100A-E

4. Update Record

版次	更新记录	更新作者	更新日期
1	第一版	周杰	2012-1-10
2	增加包装规范	周杰	2012-5-16