

Apacer

The Most **Reliable**
Storage For Industries

SM230-CFast



SM230-CFast

Overview

Apacer SM230-CFast 2.0 is the latest enhancement of conventional CFast form factor that delivers various technological advantages. This new flash memory card comes with SATA 6.0 Gbps interface for higher performance and consists of SATA-based 7-pin signal segment and 17-pin for power and control purposes. Designed without DRAM on the internal controlling unit, SM230-CFast ensures data integrity by preventing data loss during a sudden power outage.



Feature

- Built-in hardware ECC
- Global Wear Leveling
- Flash bad-block management
- S.M.A.R.T. SSD Widget
- Power Failure Management
- TRIM Support
- Support TCG Opal 2.0/AES 256-bit hardware encryption

Specifications

Model	SM230-CFast
Interface	SATA 3.2 (6Gb/s)
Connector	7 + 17 pin female connector
Form Factor	CFast
NAND Flash Type	MLC
Capacity	8GB~256GB
External DRAM	No
Sustained Read Performance (MB/sec)	Up to 560
Sustained Write Performance (MB/sec)	Up to 465
ECC Engine	Built-in up to 72-bit per 1K bytes BCH ECC
IOPS (4K Random Write)	41K
Standard Operating Temperature (°C)	0 ~ + 70
Storage Temperature (°C)	-40 ~ + 100
Housing	YES
H/W Write Protect	YES
Thermal Sensor	YES
Shock	Operation: 50G, 11ms Non-operation: 1500G, 0.5ms
Vibration	Operation: 7.69 Grms, 20~2000 Hz/random (compliant with MIL-STD-810G) Non-operation: 4.02 Grms, 15 ~ 2000 Hz/sine (compliant with MIL-STD-810G)
Operating Voltage	3.3V ± 5% (3.135-3.465V)
Power Consumption	Active mode: 645 mA / Idle mode: 135 mA
Dimension (L x W x H)	42.80mm x 36.45mm x 3.60mm
MTBF (hours)	>1,000,000

Mechanical Specification

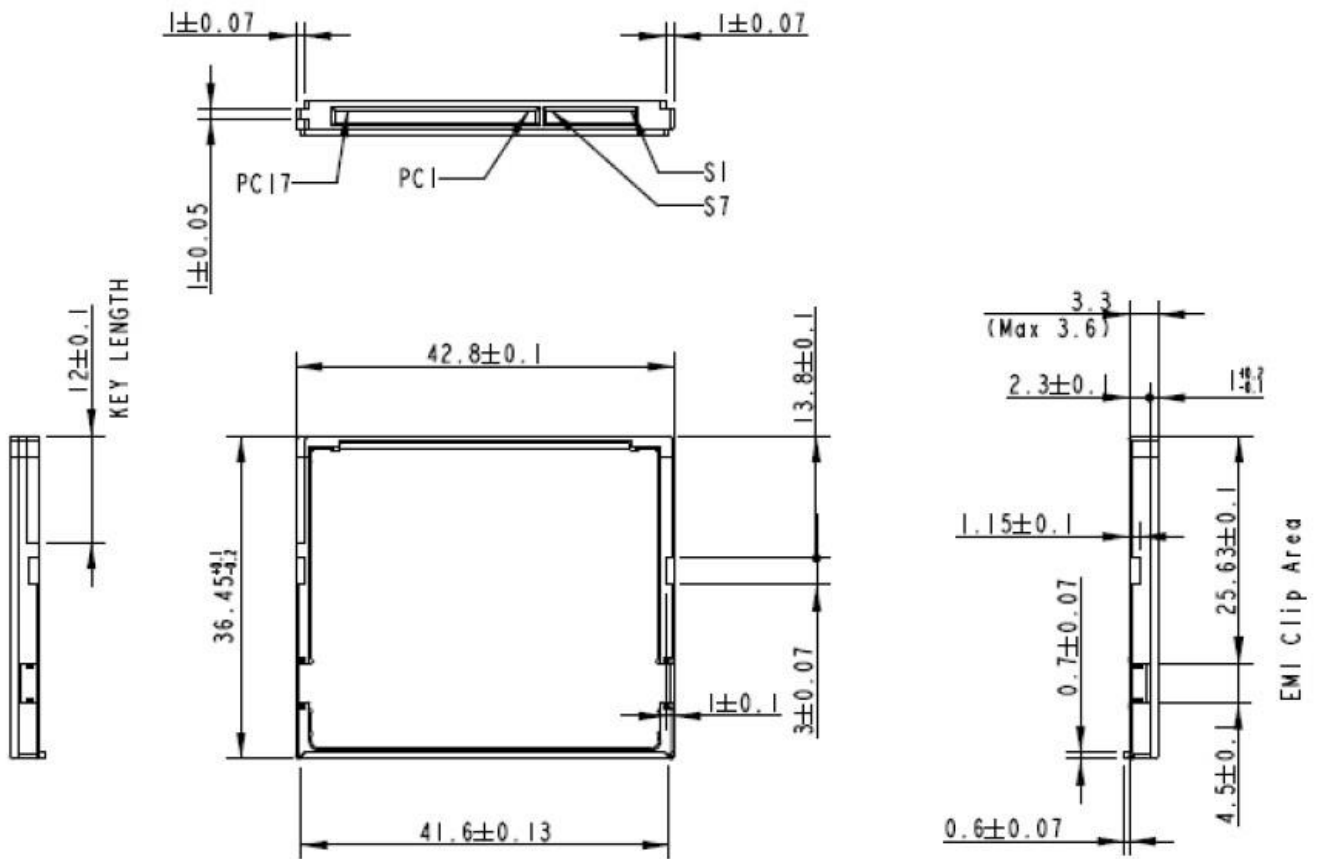

Unit: mm

For more information,
contact your Apacer representative

Global Presence

Taiwan (Headquarters)
Apacer Technology Inc.
Tel: +886-2-2267-8000
Fax: +886-2-2267-2261

Europe
Apacer Technology B.V.
Tel: +31-40-267-0000
Fax: +31-40-290-0686

U.S.A.
Apacer Memory America, Inc.
Tel: +1-408-518-8699
Fax: 1-510-249-9551

China
Apacer Electronic(Shanghai)
Co., Ltd.
Tel: +86-21-6228-9939

Japan
Apacer Technology Corp.
Tel: +81-3-5419-2668
Fax: +81-3-5419-0018

India
Apacer Technologies Pvt. Ltd.
Tel: +91-80-41529061~3
Fax: +91-80-41700215