

N-Channel Enhancement Mode MOSFET

Features

- 30V/60A,
 $R_{DS(ON)}=5.7m\Omega$ (Max.) @ $V_{GS}=10V$
 $R_{DS(ON)}=8m\Omega$ (Max.) @ $V_{GS}=4.5V$
- Super High Dense Cell Design
- Reliable and Rugged
- Lead Free and Green Devices Available
 (RoHS Compliant)

Pin Description



Top View of TO-251

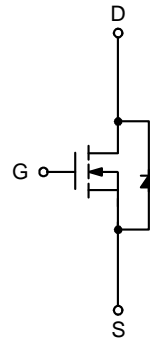

N-Channel MOSFET

Applications

- Power Management in Desktop Computer or DC/DC Converters.

Ordering and Marking Information

<p>SM3116NS □□□-□□□</p> <div style="margin-left: 40px;"> <p>└─ Assembly Material</p> <p>└─ Handling Code</p> <p>└─ Temperature Range</p> <p>└─ Package Code</p> </div>	<p>Package Code UC : TO-251</p> <p>Operating Junction Temperature Range C : -55 to 150 °C</p> <p>Handling Code TU : Tube (80ea/tube)</p> <p>Assembly Material G : Halogen and Lead Free Device</p>
<p>SM3116NS UC :</p> <div style="border: 1px solid black; display: inline-block; padding: 2px; margin-left: 10px;">  <p style="margin: 0;">SM3116N XXXXX</p> </div>	<p>XXXXX - Date Code</p>

Note : SINOPOWER lead-free products contain molding compounds/die attach materials and 100% matte tin plate termination finish; which are fully compliant with RoHS. SINOPOWER lead-free products meet or exceed the lead-free requirements of IPC/JEDEC J-STD-020D for MSL classification at lead-free peak reflow temperature. SINOPOWER defines “Green” to mean lead-free (RoHS compliant) and halogen free (Br or Cl does not exceed 900ppm by weight in homogeneous material and total of Br and Cl does not exceed 1500ppm by weight).

SINOPOWER reserves the right to make changes to improve reliability or manufacturability without notice, and advise customers to obtain the latest version of relevant information to verify before placing orders.

Absolute Maximum Ratings

Symbol	Parameter	Rating	Unit	
Common Ratings ($T_A=25^\circ\text{C}$ Unless Otherwise Noted)				
V_{DSS}	Drain-Source Voltage	30	V	
V_{GSS}	Gate-Source Voltage	± 20		
T_J	Maximum Junction Temperature	150	$^\circ\text{C}$	
T_{STG}	Storage Temperature Range	-55 to 150	$^\circ\text{C}$	
I_S	Diode Continuous Forward Current	20	A	
I_{DP}	300 μs Pulse Drain Current Tested	$T_C=25^\circ\text{C}$	140	A
		$T_C=100^\circ\text{C}$	90	
I_D^a	Continuous Drain Current	$T_C=25^\circ\text{C}$	60*	A
		$T_C=100^\circ\text{C}$	48	
P_D	Maximum Power Dissipation	$T_C=25^\circ\text{C}$	50	W
		$T_C=100^\circ\text{C}$	20	
$R_{\theta JC}$	Thermal Resistance-Junction to Case	Steady State	2.5	$^\circ\text{C}/\text{W}$
$R_{\theta JA}$	Thermal Resistance-Junction to Ambient	$t \leq 10\text{s}$	15	$^\circ\text{C}/\text{W}$
		Steady State	45	
I_{AS}^b	Avalanche Current, Single pulse ($L=0.5\text{mH}$)	20	A	
E_{AS}^b	Avalanche Energy, Single pulse ($L=0.5\text{mH}$)	100	mJ	

Note a : * Current limited by bond wire.

Note b : UIS tested and pulse width limited by maximum junction temperature 150°C (initial temperature $T_J=25^\circ\text{C}$).

Electrical Characteristics ($T_A = 25^\circ\text{C}$ unless otherwise noted)

Symbol	Parameter	Test Conditions	SM3116NSUC			Unit
			Min.	Typ.	Max.	
Static Characteristics						
BV_{DSS}	Drain-Source Breakdown Voltage	$V_{GS}=0\text{V}, I_{DS}=250\mu\text{A}$	30	-	-	V
I_{DSS}	Zero Gate Voltage Drain Current	$V_{DS}=24\text{V}, V_{GS}=0\text{V}$	-	-	1	μA
		$T_J=85^\circ\text{C}$	-	-	30	
$V_{GS(th)}$	Gate Threshold Voltage	$V_{DS}=V_{GS}, I_{DS}=250\mu\text{A}$	1.5	1.8	2.5	V
I_{GSS}	Gate Leakage Current	$V_{GS}=\pm 20\text{V}, V_{DS}=0\text{V}$	-	-	± 100	nA
$R_{DS(ON)}^c$	Drain-Source On-state Resistance	$V_{GS}=10\text{V}, I_{DS}=40\text{A}$	-	4.7	5.7	m Ω
		$T_J=125^\circ\text{C}$	-	6.9	-	
		$V_{GS}=4.5\text{V}, I_{DS}=20\text{A}$	-	6	8	
Gfs	Forward Transconductance	$V_{DS}=5\text{V}, I_{DS}=40\text{A}$	-	95	-	S

Electrical Characteristics (Cont.) ($T_A = 25^\circ\text{C}$ unless otherwise noted)

Symbol	Parameter	Test Conditions	SM3116NSUC			Unit
			Min.	Typ.	Max.	
Diode Characteristics						
V_{SD}^c	Diode Forward Voltage	$I_{SD}=20\text{A}, V_{GS}=0\text{V}$	-	0.8	1.1	V
t_{rr}	Reverse Recovery Time	$I_{DS}=40\text{A}, dI_{SD}/dt=100\text{A}/\mu\text{s}$	-	26	-	ns
t_a	Charge Time		-	15	-	
t_b	Discharge Time		-	11	-	
Q_{rr}	Reverse Recovery Charge		-	9	-	nC
Dynamic Characteristics^d						
R_G	Gate Resistance	$V_{GS}=0\text{V}, V_{DS}=0\text{V}, F=1\text{MHz}$	-	2.5	-	Ω
C_{iss}	Input Capacitance	$V_{GS}=0\text{V}, V_{DS}=15\text{V},$ Frequency=1.0MHz	-	1700	-	pF
C_{oss}	Output Capacitance		-	270	-	
C_{rss}	Reverse Transfer Capacitance		-	175	-	
$t_{d(ON)}$	Turn-on Delay Time	$V_{DD}=15\text{V}, R_L=15\Omega,$ $I_{DS}=1\text{A}, V_{GEN}=10\text{V},$ $R_G=6\Omega$	-	15	28	ns
t_r	Turn-on Rise Time		-	13	24	
$t_{d(OFF)}$	Turn-off Delay Time		-	39	71	
t_f	Turn-off Fall Time		-	10	32	
Gate Charge Characteristics^d						
Q_g	Total Gate Charge	$V_{DS}=15\text{V}, V_{GS}=4.5\text{V},$ $I_{DS}=40\text{A}$	-	14	-	nC
Q_g	Total Gate Charge	$V_{DS}=15\text{V}, V_{GS}=10\text{V},$ $I_{DS}=40\text{A}$	-	28	39	
Q_{gth}	Threshold Gate Charge		-	3	-	
Q_{gs}	Gate-Source Charge		-	3.7	-	
Q_{gd}	Gate-Drain Charge		-	7.9	-	

Note c : Pulse test ; pulse width $\leq 300\mu\text{s}$, duty cycle $\leq 2\%$.

Note d : Guaranteed by design, not subject to production testing.

Typical Operating Characteristics

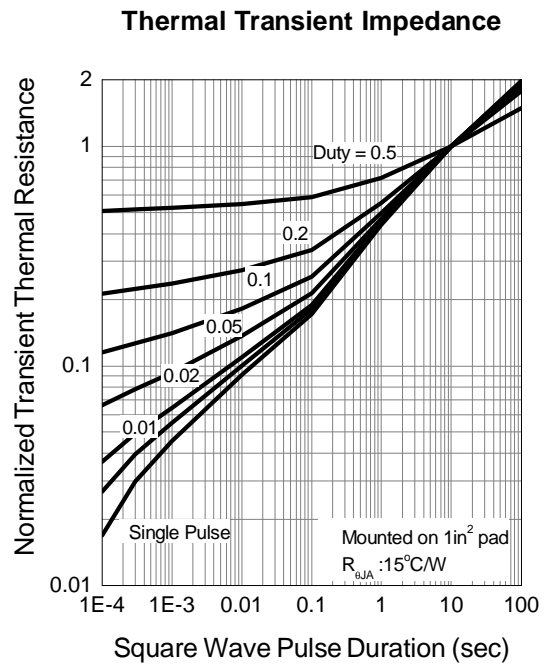
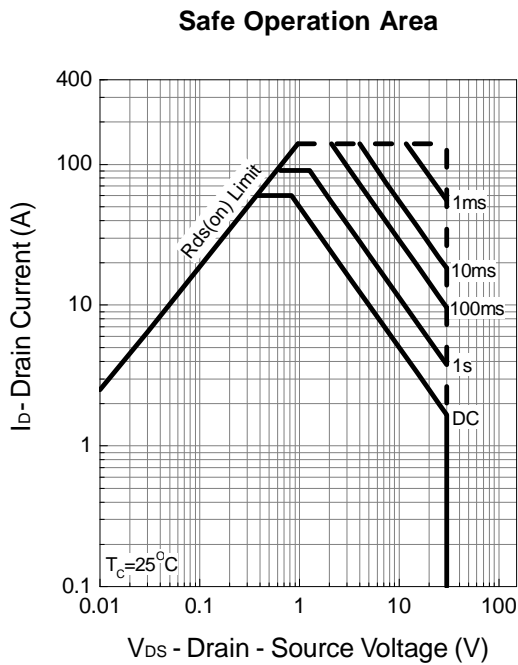
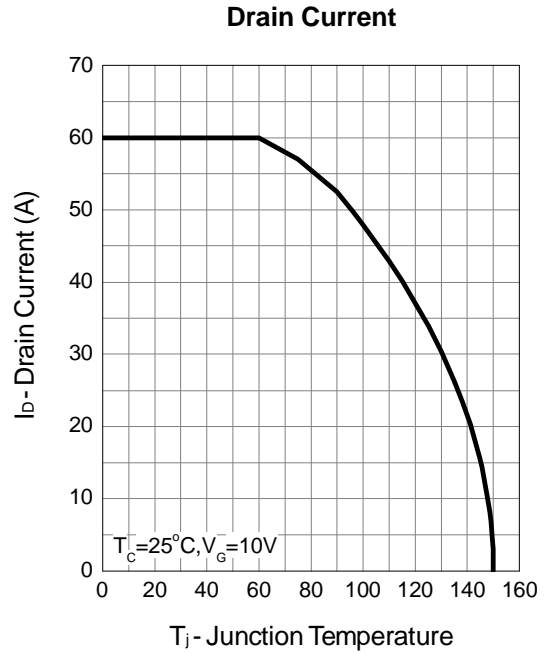
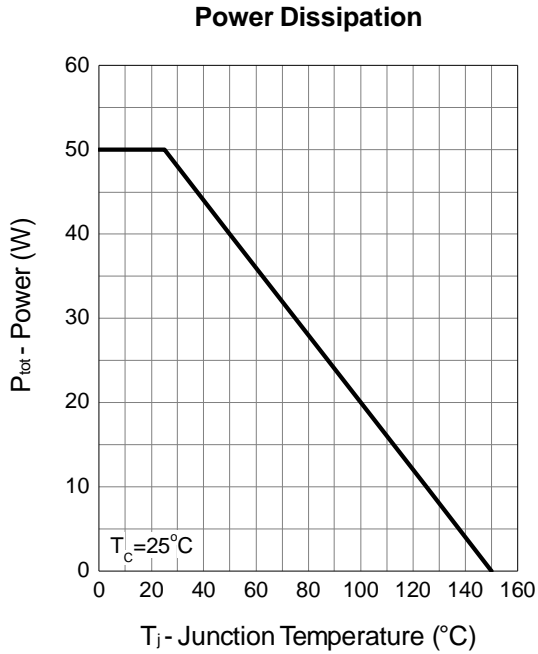

Typical Operating Characteristics (Cont.)

Output Characteristics

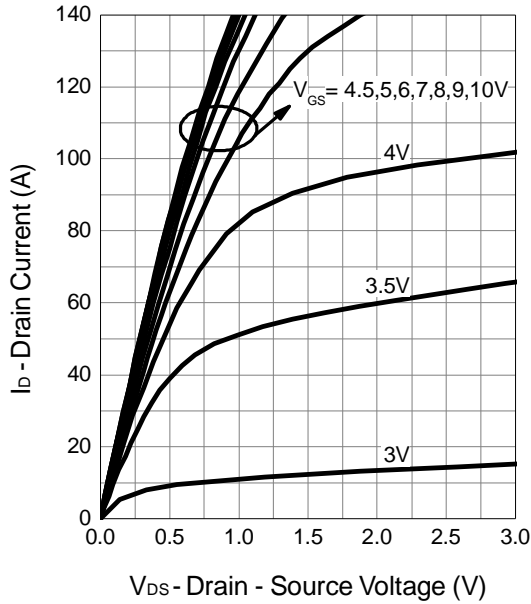

Drain-Source On Resistance

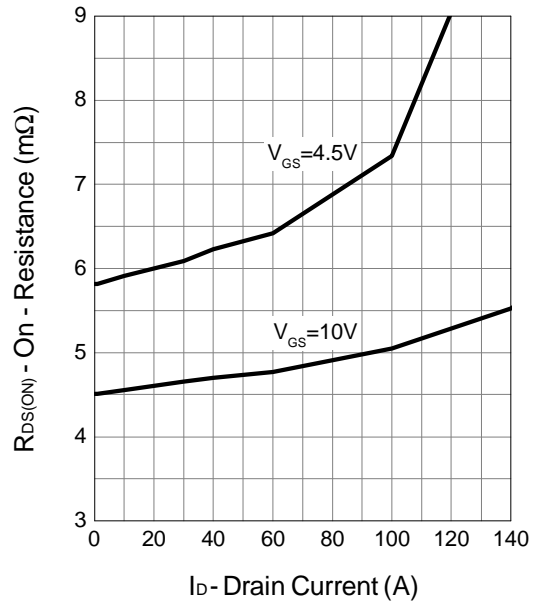

Gate-Source On Resistance

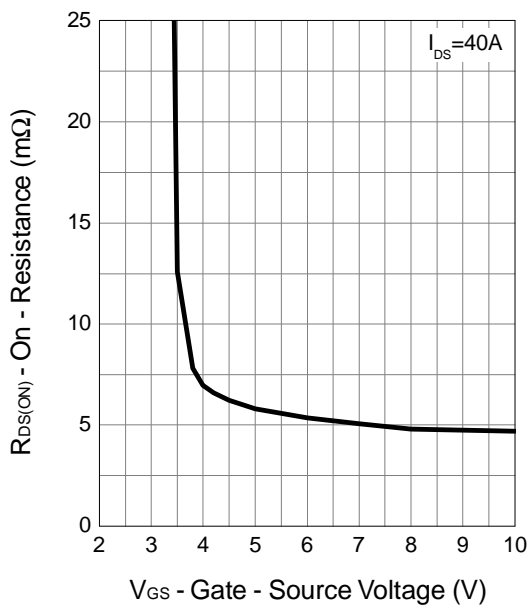

Gate Threshold Voltage

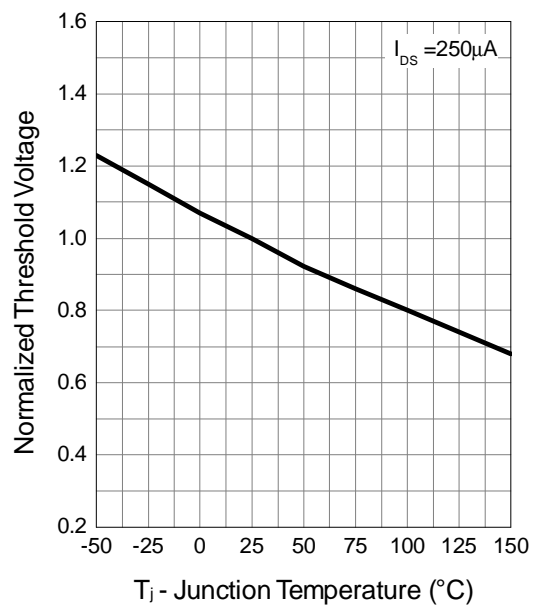

Typical Operating Characteristics (Cont.)

Drain-Source On Resistance

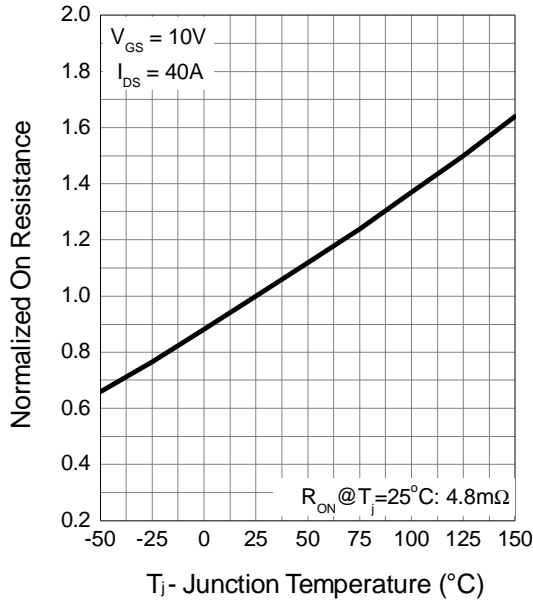

Source-Drain Diode Forward

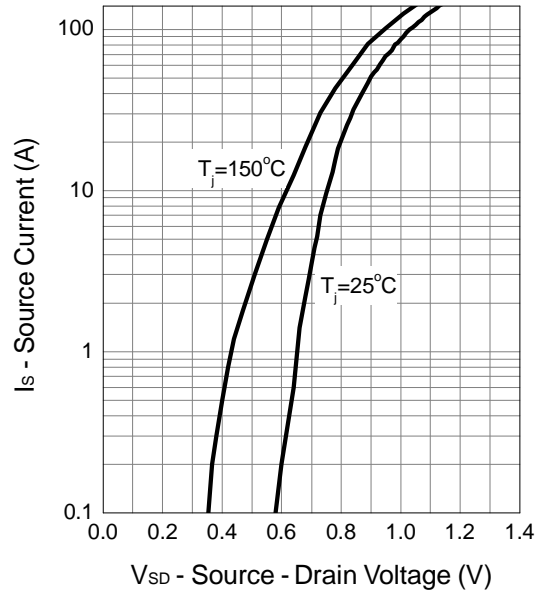

Capacitance

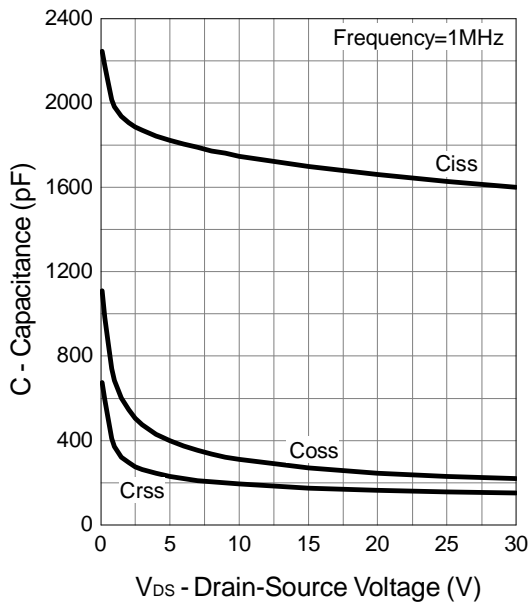

Gate Charge

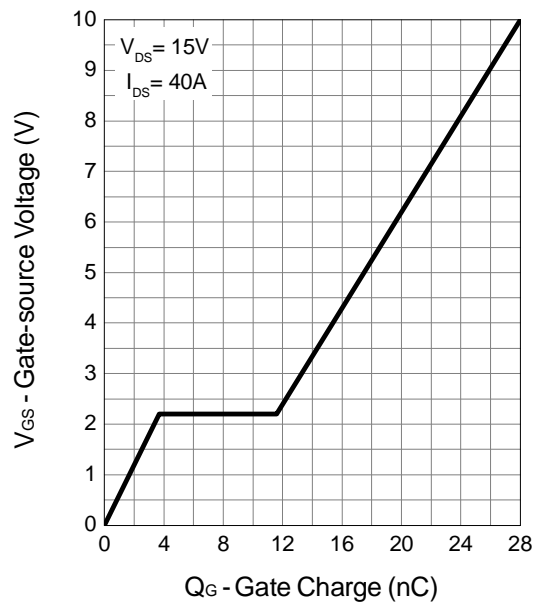

Avalanche Test Circuit and Waveforms

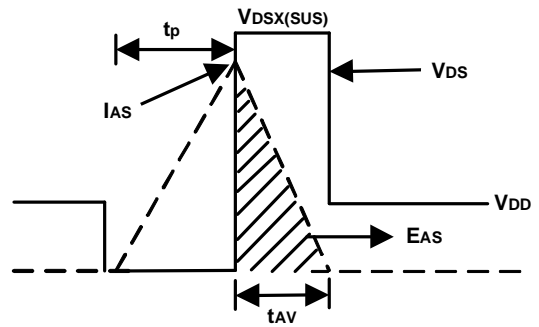
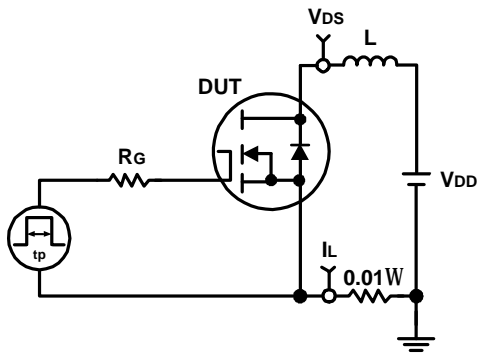

Switching Time Test Circuit and Waveforms

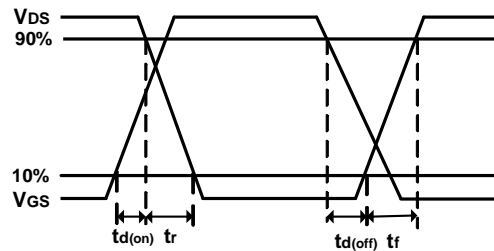
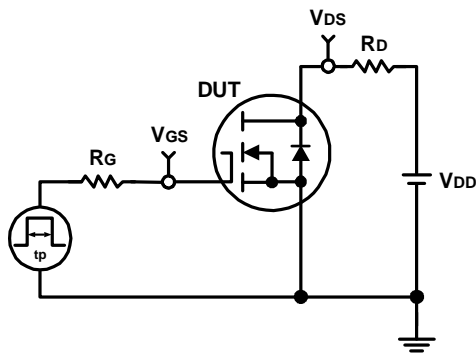

Package Information

TO-251

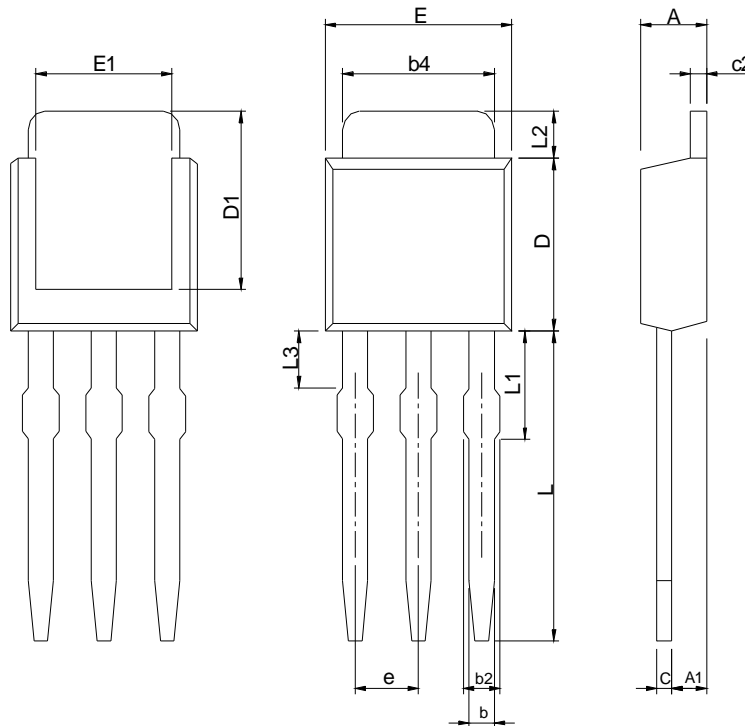

SYMBOL	TO-251(AC)			
	MILLIMETERS		INCHES	
	MIN.	MAX.	MIN.	MAX.
A	2.10	2.50	0.083	0.098
A1	0.89	1.14	0.035	0.045
b	0.40	0.89	0.016	0.035
b2	0.50	1.14	0.020	0.045
b4	4.80	5.46	0.189	0.215
c	0.35	0.65	0.014	0.026
c2	0.40	0.89	0.016	0.035
D	5.30	6.22	0.209	0.245
D1	4.90	-	0.193	-
E	6.30	6.73	0.248	0.265
E1	4.32	-	0.170	-
e	2.29 BSC		0.090 BSC	
L	3.20	3.80	0.126	0.150
L1	1.40	2.29	0.055	0.090
L2	0.89	1.70	0.035	0.067
L3	0.50	1.52	0.020	0.060

RECOMMENDED LAND PATTERN

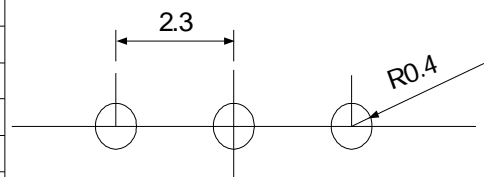

UNIT: mm

Classification Profile

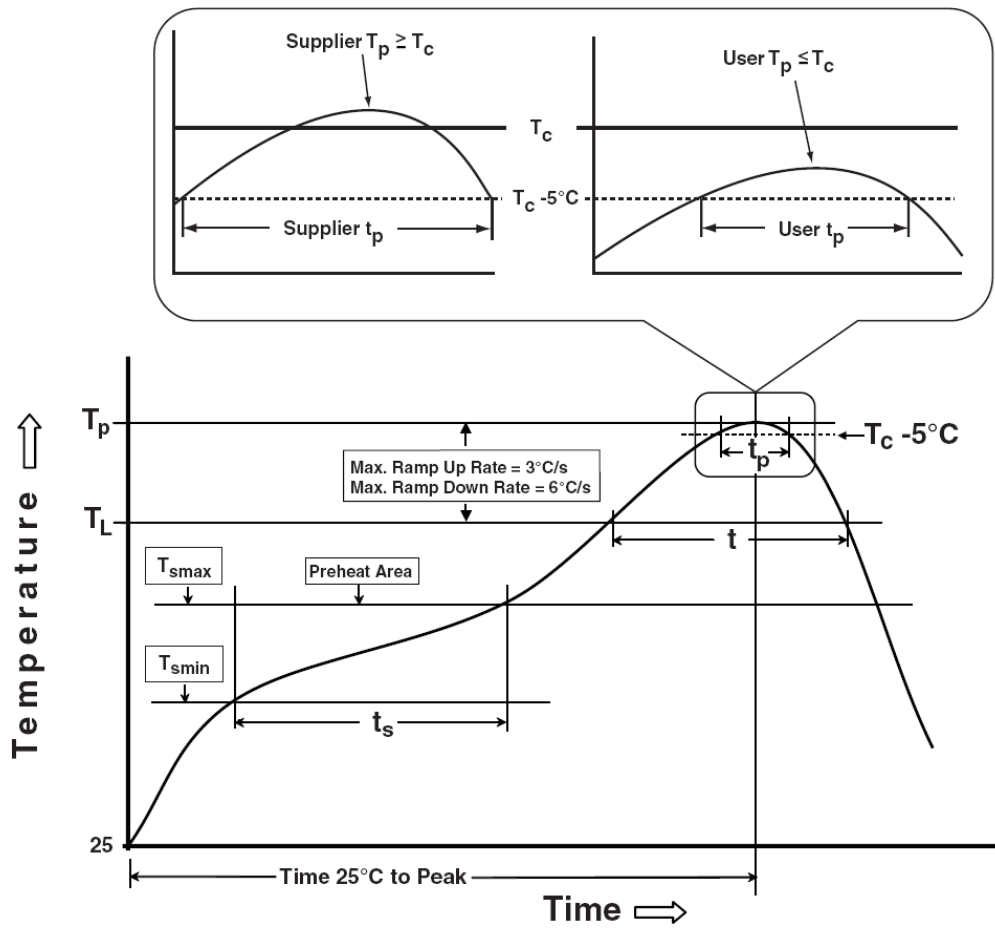

Classification Reflow Profiles

Profile Feature	Sn-Pb Eutectic Assembly	Pb-Free Assembly
Preheat & Soak		
Temperature min (T_{smin})	100 °C	150 °C
Temperature max (T_{smax})	150 °C	200 °C
Time (T_{smin} to T_{smax}) (t_s)	60-120 seconds	60-120 seconds
Average ramp-up rate (T_{smax} to T_p)	3 °C/second max.	3°C/second max.
Liquidous temperature (T_L)	183 °C	217 °C
Time at liquidous (t_L)	60-150 seconds	60-150 seconds
Peak package body Temperature (T_p)*	See Classification Temp in table 1	See Classification Temp in table 2
Time (t_p)** within 5°C of the specified classification temperature (T_c)	20** seconds	30** seconds
Average ramp-down rate (T_p to T_{smax})	6 °C/second max.	6 °C/second max.
Time 25°C to peak temperature	6 minutes max.	8 minutes max.
* Tolerance for peak profile Temperature (T_p) is defined as a supplier minimum and a user maximum.		
** Tolerance for time at peak profile temperature (t_p) is defined as a supplier minimum and a user maximum.		

Table 1. SnPb Eutectic Process – Classification Temperatures (T_c)

Package Thickness	Volume mm ³ <350	Volume mm ³ ≥350
<2.5 mm	235 °C	220 °C
≥2.5 mm	220 °C	220 °C

Table 2. Pb-free Process – Classification Temperatures (T_c)

Package Thickness	Volume mm ³ <350	Volume mm ³ 350-2000	Volume mm ³ >2000
<1.6 mm	260 °C	260 °C	260 °C
1.6 mm – 2.5 mm	260 °C	250 °C	245 °C
≥2.5 mm	250 °C	245 °C	245 °C

Reliability Test Program

Test item	Method	Description
SOLDERABILITY	JESD-22, B102	5 Sec, 245°C
HOLT	JESD-22, A108	1000 Hrs, Bias @ 125°C
PCT	JESD-22, A102	168 Hrs, 100%RH, 2atm, 121°C
TCT	JESD-22, A104	500 Cycles, -65°C~150°C

Customer Service

Sinopower Semiconductor, Inc.

5F, No. 6, Dusing 1St Rd., Hsinchu Science Park,

Hsinchu, 30078, Taiwan

TEL: 886-3-5635818 Fax: 886-3-5642050