



## SM802108

ClockWorks™ 10GbE & GbE (156.25MHz, 125MHz) Ultra-Low Jitter, LVPECL Frequency Synthesizer

### General Description

The SM802108 is a member of the ClockWorks™ family of devices from Micrel and provides an extremely low-noise timing solution for GbE and 10GbE Ethernet clock signals. It is based upon a unique patented RotaryWave® architecture that provides very low phase noise.

The device operates from a 3.3V or 2.5V power supply and synthesizes two LVPECL output clocks at 156.25MHz and another two at 125MHz. The SM802108 accepts a 25 MHz crystal or LVCMOS reference clock.

Data sheets and support documentation can be found on Micrel's web site at: [www.micrel.com](http://www.micrel.com).

### Features

- Generates two LVPECL clock outputs at 156.25MHz and two LVPECL clock outputs at 125MHz
- 2.5V or 3.3V operating range
- Typical phase jitter @ 156.25MHz (1.875MHz to 20MHz): 110fs (typical) at 3.3V
- Industrial temperature range
- Green, RoHS, and PFOS compliant
- Available in 24-pin 4mm × 4mm QFN package

### Applications

- 10Gigabit Ethernet
- Gigabit Ethernet

### Block Diagram

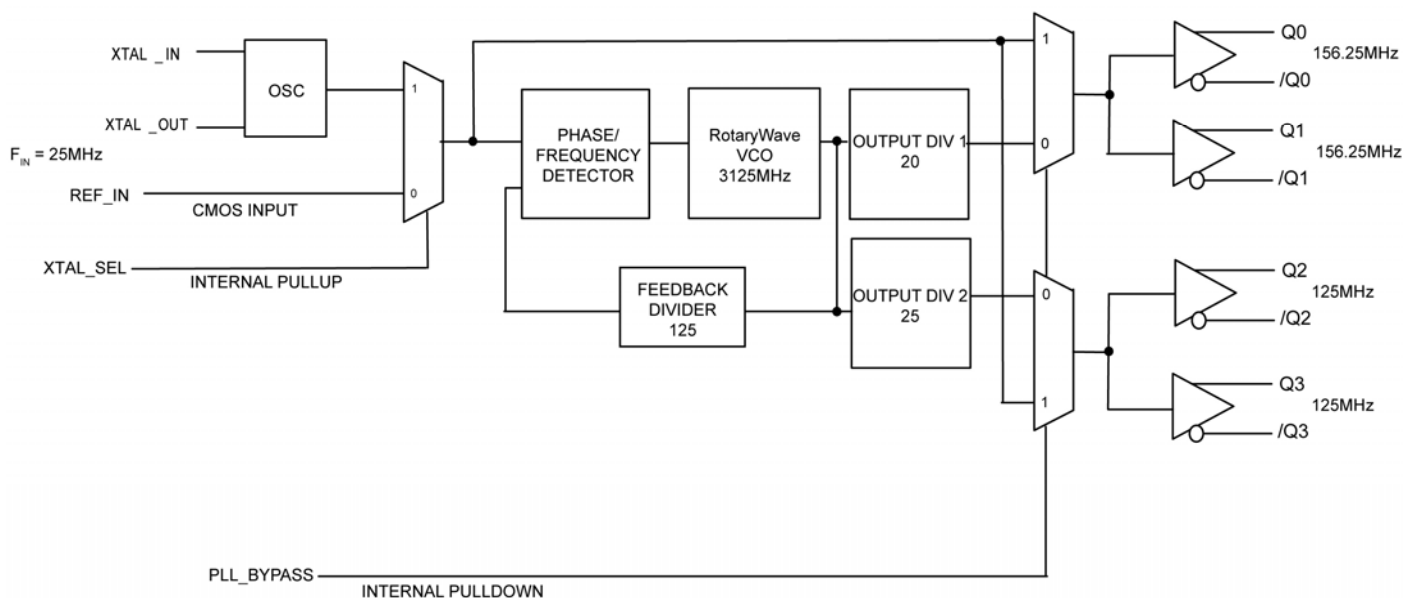

ClockWorks is a trademark of Micrel, Inc  
RotaryWave is a registered trademark of Multigig, Inc.

Micrel Inc. • 2180 Fortune Drive • San Jose, CA 95131 • USA • tel +1 (408) 944-0800 • fax + 1 (408) 474-1000 • <http://www.micrel.com>

January 2011

M9999-012111-A  
[hbwhelp@micrel.com](mailto:hbwhelp@micrel.com) or (408) 955-1690

## Ordering Information

Part Number	Marking	Shipping	Junction Temperature Range	Package
SM802108UMG	802108	Tube	-40°C to +85°C	24-Pin QFN
SM802108UMGR	802108	Tape and Reel	-40°C to +85°C	24-Pin QFN

### Note:

1. Devices are Green, RoHS, and PFOS compliant.

## Pin Configuration

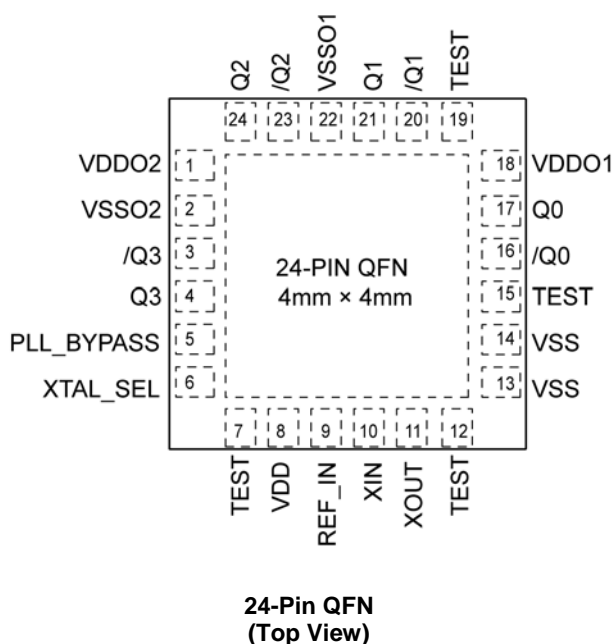

## Pin Description

Pin Number	Pin Name	Pin Type	Pin Level	Pin Function
16, 17 20, 21	/Q0, Q0 /Q1, Q1	O, (DIF)	LVPECL	Differential Clock Outputs from Bank 1 156.25MHz
23, 24 3, 4	/Q2, Q2 /Q3, Q3	O, (DIF)	LVPECL	Differential Clock Outputs from Bank 2 125MHz
1	VDDO2	PWR		Power Supply for Output Bank 2
2	VSSO2	PWR		Power Supply Ground for Output Bank 2
5	PLL_BYPASS	I, (SE)	LVC MOS	PLL Bypass, Selects Output Source 0 = Normal PLL Operation 1 = Output from Input Reference Clock or Crystal 45KΩ pull-down
6	XTAL_SEL	I, (SE)	LVC MOS	Selects PLL Input Reference Source 0 = REF_IN, 1 = XTAL, 45KΩ pull-up

## Pin Description (Continued)

Pin Number	Pin Name	Pin Type	Pin Level	Pin Function
7, 12, 15, 19	TEST			Factory Test Pins, Do not connect anything to these pins.
8	VDD	PWR		Core Power Supply
9	REF_IN	I, (SE)	LVC MOS	Reference Clock Input
10	XIN	I, (SE)	12pF crystal	Crystal Reference Input, no load caps needed. See Fig. 5.
11	XOUT	O, (SE)	12pF crystal	Crystal Reference Output, no load caps needed. See Fig. 5.
13, 14	VSS	PWR		Core Power Supply Ground
18	VDDO1	PWR		Power Supply for Output Bank 1
22	VSSO1	PWR		Power Supply Ground for Output Bank 1

## Application Information

### Input Reference

When operating with a crystal input reference, do not apply a switching signal to REF\_IN.

### Crystal Layout

Keep the layers under the crystal as open as possible. Do not place switching signals or noisy supplies under the crystal.

## Truth Table

PLL_BYPASS	XTAL_SEL	INPUT	OUTPUT
0	–	–	PLL
1	–	–	XTAL/REF_IN
–	0	REF_IN	–
–	1	XTAL	–

### Absolute Maximum Ratings<sup>(1)</sup>

Supply Voltage ( $V_{DD}$ , $V_{DDOx}$ )	+4.6V
Input Voltage ( $V_{IN}$ )	-0.50V to $V_{DD} + 0.5V$
Lead Temperature (soldering, 20sec.)	260°C
Case Temperature	115°C
Storage Temperature ( $T_s$ )	-65°C to +150°C

### Operating Ratings<sup>(2)</sup>

Supply Voltage ( $V_{DD}$ , $V_{DDOx}$ )	+2.375V to +3.465V
Ambient Temperature ( $T_A$ )	-40°C to +85°C
Junction Thermal Resistance <sup>(3)</sup>	
QFN ( $\theta_{JA}$ )	
Still-Air	50°C/W
QFN ( $\psi_{JB}$ )	
Junction-to-Board	30°C/W

### DC Electrical Characteristics<sup>(4)</sup>

$V_{DD} = V_{DDO1/2} = 3.3V \pm 5\%$  or  $2.5V \pm 5\%$   
 $V_{DD} = 3.3V \pm 5\%$ ,  $V_{DDO1/2} = 3.3V \pm 5\%$  or  $2.5V \pm 5\%$   
 $T_A = -40^\circ\text{C}$  to  $+85^\circ\text{C}$ .

Symbol	Parameter	Condition	Min.	Typ.	Max.	Units
$V_{DD}$ , $V_{DDOx}$	2.5V Operating Voltage		2.375	2.5	2.625	V
$V_{DD}$ , $V_{DDOx}$	3.3V Operating Voltage		3.135	3.3	3.465	V
$I_{DD}$	Supply current $V_{DD} + V_{DDO}$	Outputs open; REF_IN source, XTAL_SEL = 0		130	165	mA
$I_{DD}$	Supply current $V_{DD} + V_{DDO}$	Outputs open; CRYSTAL source, XTAL_SEL = 1		145	185	mA

### LVPECL DC Electrical Characteristics<sup>(4)</sup>

$V_{DD} = V_{DDO1/2} = 3.3V \pm 5\%$  or  $2.5V \pm 5\%$   
 $V_{DD} = 3.3V \pm 5\%$ ,  $V_{DDO1/2} = 3.3V \pm 5\%$  or  $2.5V \pm 5\%$   
 $T_A = -40^\circ\text{C}$  to  $+85^\circ\text{C}$ .  $R_L = 50\Omega$  to  $V_{DDO} - 2V$

Symbol	Parameter	Condition	Min.	Typ.	Max.	Units
$V_{OH}$	Output High Voltage		$V_{DDO} - 1.145$	$V_{DDO} - 0.97$	$V_{DDO} - 0.845$	V
$V_{OL}$	Output Low Voltage		$V_{DDO} - 1.945$	$V_{DDO} - 1.77$	$V_{DDO} - 1.645$	V
$V_{SWING}$	Output Voltage Swing		0.6	0.8	1.0	V

- Note:**
1. Permanent device damage may occur if absolute maximum ratings are exceeded. This is a stress rating only and functional operation is not implied at conditions other than those detailed in the operational sections of this data sheet. Exposure to absolute maximum rating conditions for extended periods may affect device reliability.
  2. The data sheet limits are not guaranteed if the device is operated beyond the operating ratings.
  3. Package thermal resistance assumes exposed pad is soldered (or equivalent) to the devices most negative potential on the PCB.
  4. The circuit is designed to meet the AC and DC specifications shown in the above table(s) after thermal equilibrium has been established.

**LVC MOS (PLL\_BYPASS, XTAL\_SEL) DC Electrical Characteristics<sup>(4)</sup>**

$V_{DD} = 3.3V \pm 5\%$ , or  $2.5V \pm 5\%$ ,  $T_A = -40^{\circ}C$  to  $+85^{\circ}C$ .

Symbol	Parameter	Condition	Min.	Typ.	Max.	Units
$V_{IH}$	Input High Voltage		2		$V_{DD} + 0.3$	V
$V_{IL}$	Input Low Voltage		-0.3		0.8	V
$I_{IH}$	Input High Current	$V_{DD} = V_{IN} = 3.465V$			150	$\mu A$
$I_{IL}$	Input Low Current	$V_{DD} = 3.465V, V_{IN} = 0V$	-5			$\mu A$

**REF\_IN DC Electrical Characteristics<sup>(4)</sup>**

$V_{DD} = 3.3V \pm 5\%$ , or  $2.5V \pm 5\%$ ,  $T_A = -40^{\circ}C$  to  $+85^{\circ}C$ .

Symbol	Parameter	Condition	Min.	Typ.	Max.	Units
$V_{IH}$	Input High Voltage		1.1		$V_{DD} + 0.3$	V
$V_{IL}$	Input Low Voltage		-0.3		0.6	V
$I_{IN}$	Input Current	$XTAL\_SEL = V_{IL}, V_{IN} = 0V$ to $V_{DD}$	-5		5	$\mu A$
$I_{IN}$	Input Current	$XTAL\_SEL = V_{IH}, V_{IN} = V_{DD}$		20		$\mu A$

**Crystal Characteristics****NDK NX2520SA**

Parameter	Condition	Min.	Typ.	Max.	Units
Mode of Oscillation	12pF Load	Fundamental, Parallel Resonant			
Frequency			25		MHz
Equivalent Series Resistance (ESR)				50	$\Omega$
Shunt Capacitor, C0			3	7	pF
Correlation Drive Level			100	300	$\mu W$

**AC Electrical Characteristics**<sup>(4, 5)</sup>
 $V_{DD} = V_{DDO1/2} = 3.3V \pm 5\%$  or  $2.5V \pm 5\%$ 
 $V_{DD} = 3.3V \pm 5\%$ ,  $V_{DDO1/2} = 3.3V \pm 5\%$  or  $2.5V \pm 5\%$ 
 $T_A = -40^\circ C$  to  $+85^\circ C$ .  $R_L = 50\Omega$  to  $V_{DDO} - 2V$ 

Symbol	Parameter	Condition	Min.	Typ.	Max.	Units
F <sub>OUT1</sub>	Output Frequency 1			156.25		MHz
F <sub>OUT2</sub>	Output Frequency 2			125		
Ppm	Output ppm Variation	Crystal reference. Note 6	-50		50	ppm
F <sub>REF</sub>	Reference Input Frequency			25		MHz
T <sub>R</sub> /T <sub>F</sub>	LVPECL Output Rise/Fall Time	20% – 80%	80	175	350	ps
ODC	Output Duty Cycle		48	50	52	%
T <sub>SKREW</sub>	Output-to-Output Skew	Within bank. Note 7			45	ps
T <sub>LOCK</sub>	PLL Lock Time				20	ms
T <sub>jitter</sub> (∅)	RMS Phase Jitter <sup>(8)</sup>	156.25MHz Integration Range (1.875MHz – 20MHz) Integration Range (12kHz – 20MHz)  125MHz Integration Range (1.875MHz – 20MHz) Integration Range (12kHz – 20MHz)		110 250  110 250		fs
	Spurious Noise Components	6.25MHz 25MHz		-73 -58		dBc

**Notes:**

- All phase noise measurements were taken with an Agilent 5052B phase noise system.
- Crystal tolerance at room less than +/- 15ppm, over temp less than +/- 20ppm.
- Defined as skew between outputs at the same supply voltage and with equal load conditions and same frequency; Measured at the output differential crossing points.
- Measured using 25MHz crystal as the input reference source.

### Phase Noise Plots

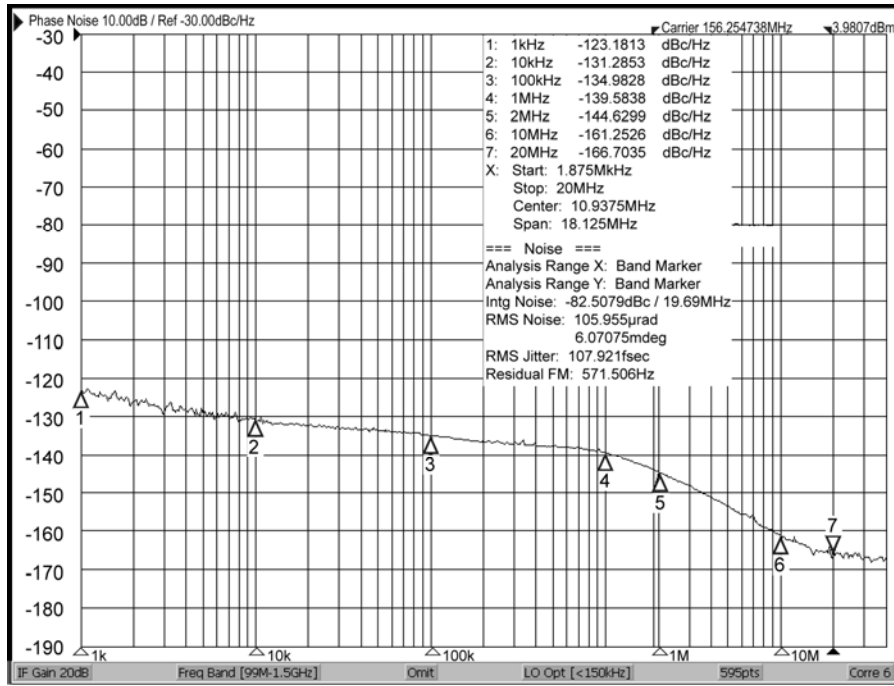

Phase Noise Plot: 156.25MHz, 1.875MHz – 20MHz 108fs

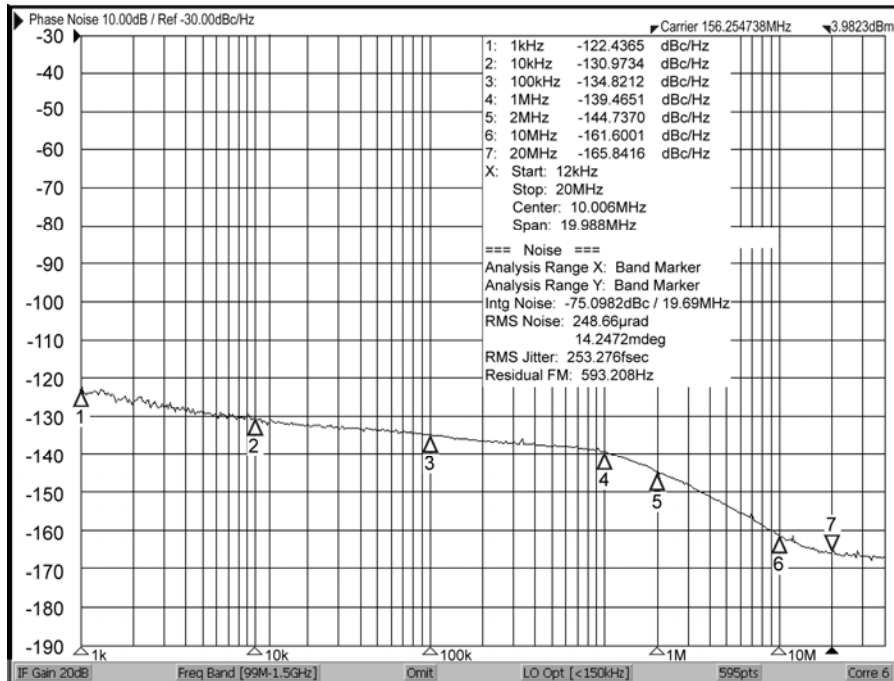

Phase Noise Plot: 156.25MHz, 12kHz – 20MHz 253fs

### Phase Noise Plots (Continued)

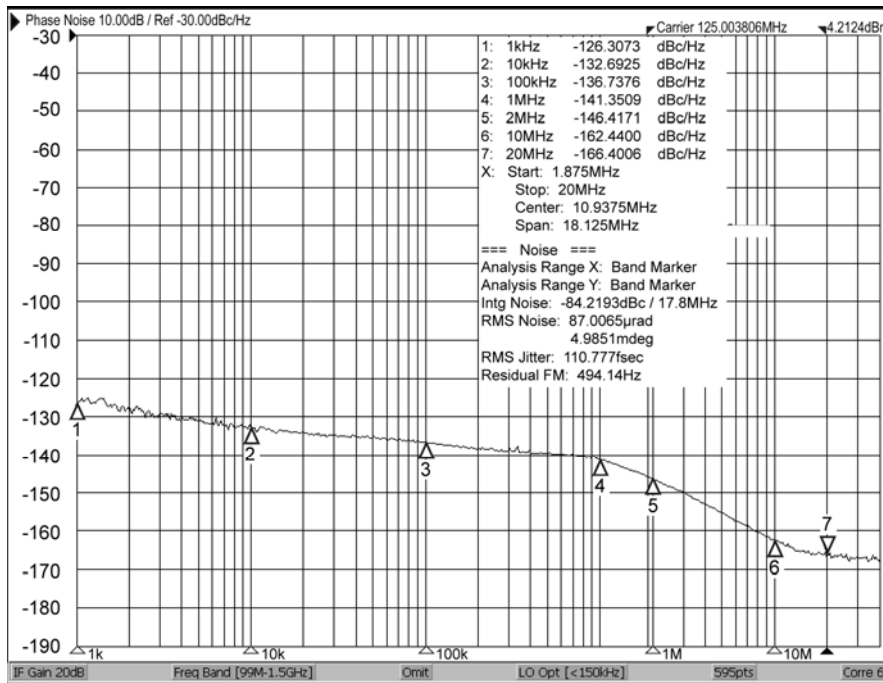

Phase Noise Plot: 125MHz, 1.875MHz – 20MHz 111fS

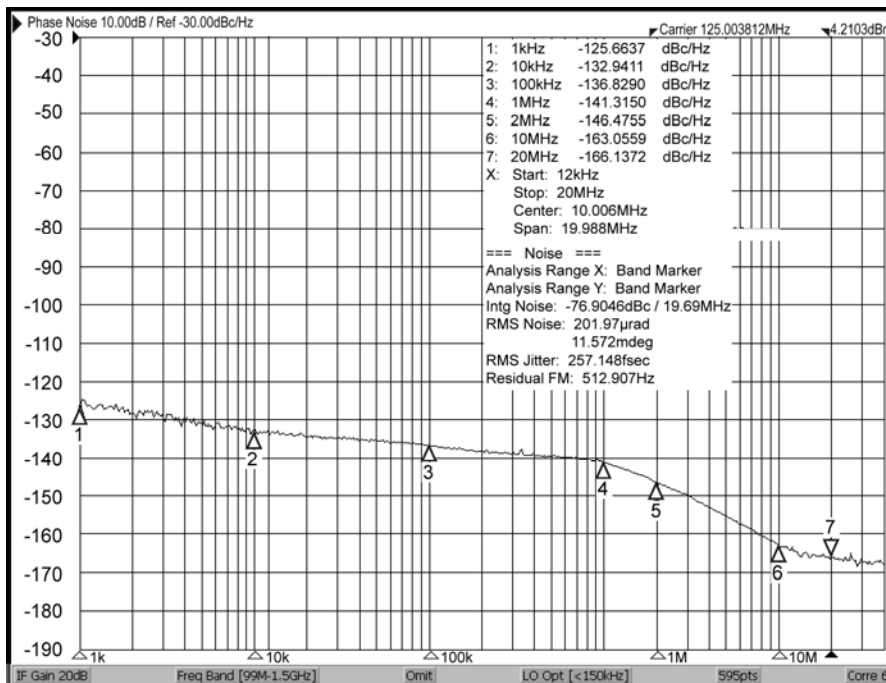

Phase Noise Plot: 125MHz, 12kHz – 20MHz 257fS



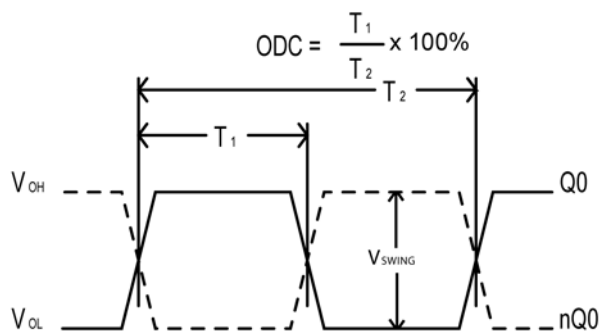

Figure 1. Duty Cycle Timing

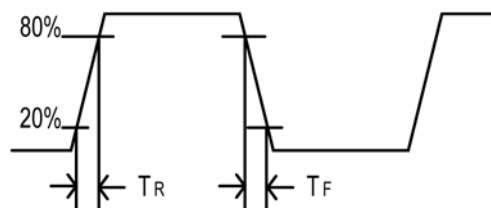

Figure 2. All Outputs Rise/Fall Time

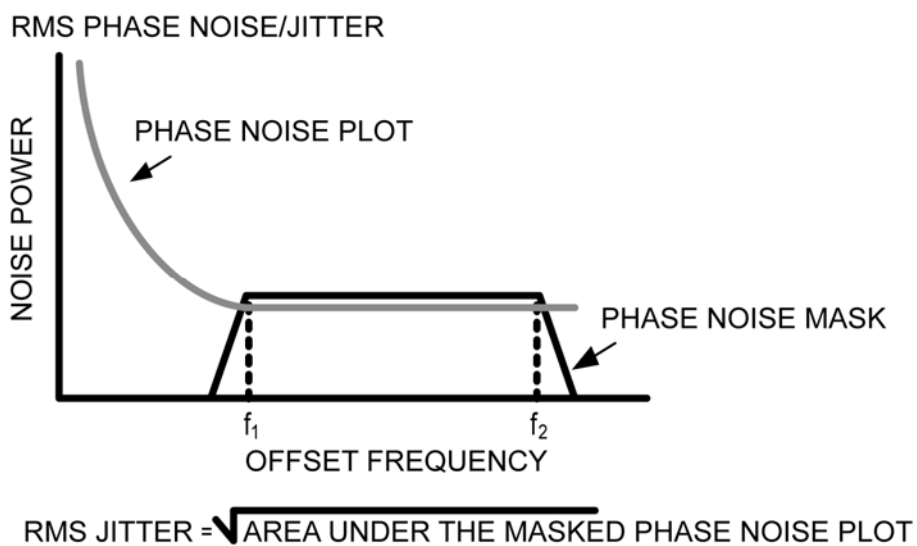

Figure 3. RMS Phase/Noise/Jitter

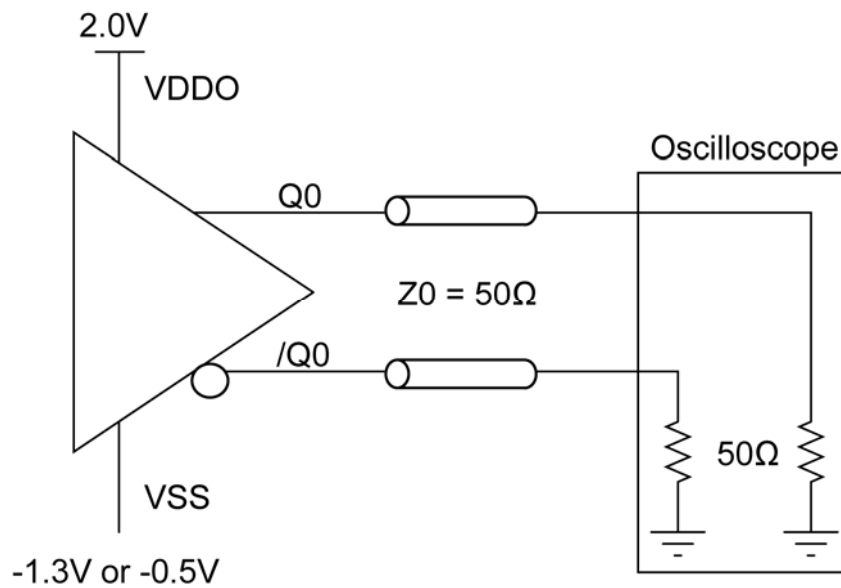

Figure 4. LVPECL Output Load and Test Circuit

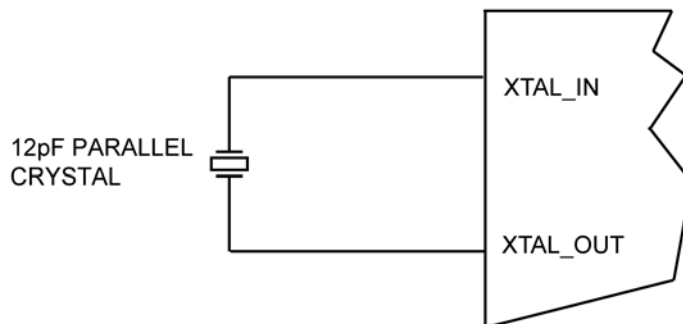
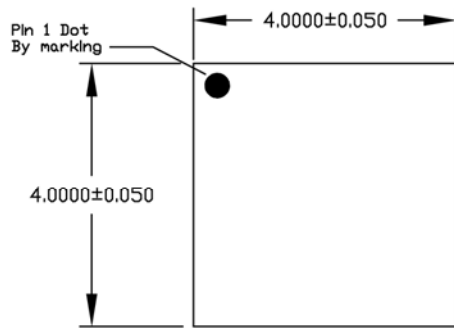
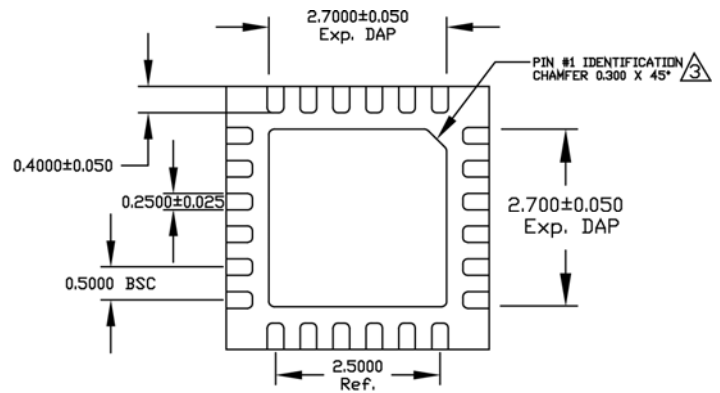

Figure 5. Crystal Input Interface

## Package Information



TOP VIEW



BOTTOM VIEW

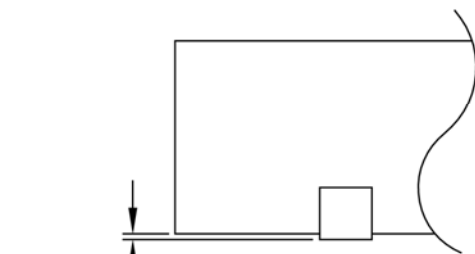

DETAIL "A"

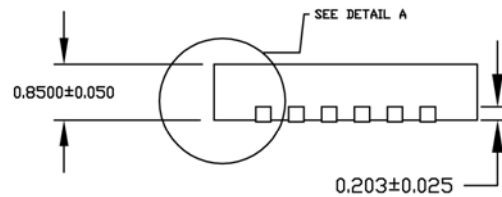

SIDE VIEW

**NOTE:**

1. ALL DIMENSIONS ARE IN MILLIMETERS (mm).
2. THE PIN#1 IDENTIFIER MUST EXIST ON THE TOP SURFACE OF PACKAGE BY USING IDENTIFICATION MARK OR OTHER FEATURE OF PACKAGE BODY.

3. CHAMFER STYLE PIN 1 IDENTIFIER ON BOTTOM SIDE

**24-Pin QFN**

**MICREL, INC. 2180 FORTUNE DRIVE SAN JOSE, CA 95131 USA**  
 TEL +1 (408) 944-0800 FAX +1 (408) 474-1000 WEB <http://www.micrel.com>

Micrel makes no representations or warranties with respect to the accuracy or completeness of the information furnished in this data sheet. This information is not intended as a warranty and Micrel does not assume responsibility for its use. Micrel reserves the right to change circuitry, specifications and descriptions at any time without notice. No license, whether express, implied, arising by estoppel or otherwise, to any intellectual property rights is granted by this document. Except as provided in Micrel's terms and conditions of sale for such products, Micrel assumes no liability whatsoever, and Micrel disclaims any express or implied warranty relating to the sale and/or use of Micrel products including liability or warranties relating to fitness for a particular purpose, merchantability, or infringement of any patent, copyright or other intellectual property right.

Micrel Products are not designed or authorized for use as components in life support appliances, devices or systems where malfunction of a product can reasonably be expected to result in personal injury. Life support devices or systems are devices or systems that (a) are intended for surgical implant into the body or (b) support or sustain life, and whose failure to perform can be reasonably expected to result in a significant injury to the user. A Purchaser's use or sale of Micrel Products for use in life support appliances, devices or systems is a Purchaser's own risk and Purchaser agrees to fully indemnify Micrel for any damages resulting from such use or sale.

© 2011 Micrel, Incorporated.