

Surface Mount Transient Voltage Suppressors (TVS)

SM8S Series 10 To 43 V 6600W

Description

The SM8S series is designed specifically to protect sensitive electronic equipment from voltage transients induced by lightning and other transient voltage events.

Features

- u Junction passivation optimized design passivated anisotropic rectifier technology
- u $T_J=175^{\circ}\text{C}$ capability suitable for high reliability and automotive requirement
- u Available in uni-directional polarity only
- u Low leakage current
- u Low forward voltage drop
- u High surge capability
- u Meets ISO7637-2 surge specification (varied by test condition)
- u Meets MSL level 1, per J-STD-020, LF maximum peak of 245°C
- u AEC-Q101 qualified
- u Compliant to RoHS Directive 2002/95/EC and in accordance to WEEE 2002/96/EC

Applications

Use in sensitive electronics protection against voltage transients induced by inductive load switching and lighting, especially for automotive load dump protection application.

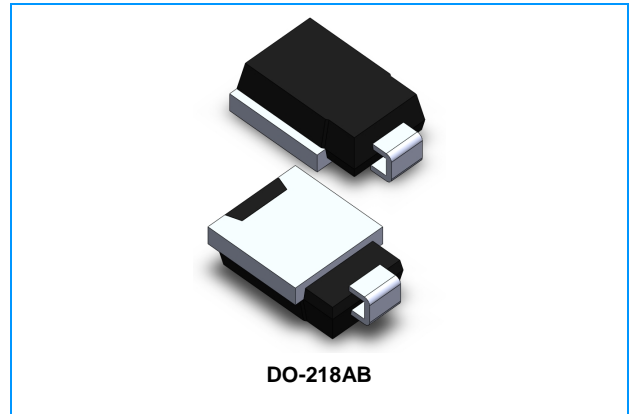

Functional Diagram

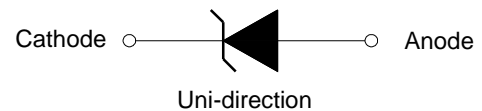

Primary Characteristics

VWM	10V to 43V
P_{PPM} (10/1000μs)	6600W
P_{PPM} (10 /10000μs)	5200W
P_D	8W
I_{FSM}	700A
T_J max.	175°C

Maximum Ratings and Thermal Characteristics (T_A=25°C unless otherwise noted)

Parameter		Symbol	Value	Unit
Peak Pulse Power Dissipation	with 10/1000μs waveform	P _{PPM}	6600	Watts
	with 10/10000μs waveform		5200	
Power Dissipation on Infinite Heat Sink at T _A =25°C (Fig.1)		P _D	8.0	Watt
Peak Pulse Current with a 10/1000μs waveform		I _{PPM} ⁽¹⁾	See Next Table	Amps
Peak Forward Surge Current, 8.3ms Single Half Sine Wave (Note 3)		I _{FSM}	700	Amps
Operating junction and Storage Temperature Range		T _J , T _{STG}	- 55 to + 175	°C
Typical thermal resistance, junction to case		R _{θJC}	0.90	°C /Watt

Notes:

1. Non-repetitive current pulse derated above T_A=25°C

Surface Mount Transient Voltage Suppressors (TVS)

SM8S Series 10 To 43 V 6600W
Electrical Characteristics (T_A=25°C unless otherwise noted)

Part Number	Stand-Off Voltage V _{MW} (V)	Breakdown Voltage V _{BR} (V)		Test Current I _T (mA)	Maximum Reverse Leakage at V _{WM} I _B (μA)	Maximum Reverse at V _{WM} T _J =175°C I _D (μA)	Maximum Peak Pulse Current at 10/1000μs Waveform (A)	Maximum Clamping Voltage at I _{PPM} V _C (V)
		MIN.	MAX.					
SM8S10	10.0	11.1	13.6	5.0	15	250	351	18.8
SM8S10A	10.0	11.1	12.3	5.0	15	250	388	17.0
SM8S11	11.0	12.2	14.9	5.0	10	150	328	20.1
SM8S11A	11.0	12.2	13.5	5.0	10	150	363	18.2
SM8S12	12.0	13.3	16.3	5.0	10	150	300	22.0
SM8S12A	12.0	13.3	14.7	5.0	10	150	332	19.9
SM8S13	13.0	14.4	17.6	5.0	10	150	277	23.8
SM8S13A	13.0	14.4	15.9	5.0	10	150	307	21.5
SM8S14	14.0	15.6	19.1	5.0	10	150	256	25.8
SM8S14A	14.0	15.6	17.2	5.0	10	150	284	23.2
SM8S15	15.0	16.7	20.4	5.0	10	150	245	26.9
SM8S15A	15.0	16.7	18.5	5.0	10	150	270	24.4
SM8S16	16.0	17.8	21.8	5.0	10	150	229	28.8
SM8S16A	16.0	17.8	19.7	5.0	10	150	254	26.0
SM8S17	17.0	18.9	23.1	5.0	10	150	216	30.5
SM8S17A	17.0	18.9	20.9	5.0	10	150	239	27.6
SM8S18	18.0	20.0	24.4	5.0	10	150	205	32.2
SM8S18A	18.0	20.0	22.1	5.0	10	150	226	29.2
SM8S20	20.0	22.2	27.1	5.0	10	150	184	35.8
SM8S20A	20.0	22.2	24.5	5.0	10	150	204	32.4
SM8S22	22.0	24.4	29.8	5.0	10	150	168	39.4
SM8S22A	22.0	24.4	26.9	5.0	10	150	186	35.5
SM8S24	24.0	26.7	32.6	5.0	10	150	153	43.0
SM8S24A	24.0	26.7	29.5	5.0	10	150	170	38.9
SM8S26	26.0	28.9	35.3	5.0	10	150	142	46.6
SM8S26A	26.0	28.9	31.9	5.0	10	150	157	42.1
SM8S28	28.0	31.1	38.0	5.0	10	150	132	50.1
SM8S28A	28.0	31.1	34.4	5.0	10	150	145	45.4
SM8S30	30.0	33.3	40.7	5.0	10	150	123	53.5
SM8S30A	30.0	33.3	36.8	5.0	10	150	136	48.4
SM8S33	33.0	36.7	44.9	5.0	10	150	112	59.0
SM8S33A	33.0	36.7	40.6	5.0	10	150	124	53.3
SM8S36	36.0	40.0	48.9	5.0	10	150	103	64.3
SM8S36A	36.0	40.0	44.2	5.0	10	150	114	58.1
SM8S40	40.0	44.4	54.3	5.0	10	150	92.4	71.4
SM8S40A	40.0	44.4	49.1	5.0	10	150	102	64.5
SM8S43	43.0	47.8	58.4	5.0	10	150	86	76.7
SM8S43A	43.0	47.8	52.8	5.0	10	150	95.1	69.4

Note:

For all types maximum V_F = 1.8V at I_F = 100A measured on 8.3 ms single half sine-wave or equivalent square wave, duty cycle = 4 pulses per minute maximum.

Surface Mount Transient Voltage Suppressors (TVS)

SM8S Series 10 To 43 V 6600W

Ratings and Characteristic Curves ($T_A=25^\circ\text{C}$ unless otherwise noted)

Figure 1 – Power Derating Curve

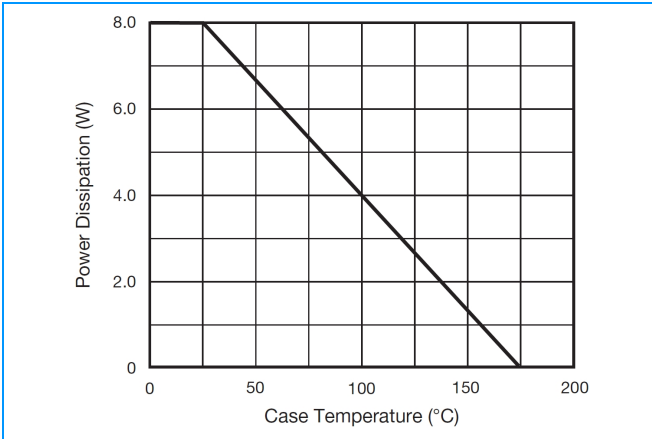

Figure 2 - Load Dump Power Characteristics (10 ms Exponential Waveform)

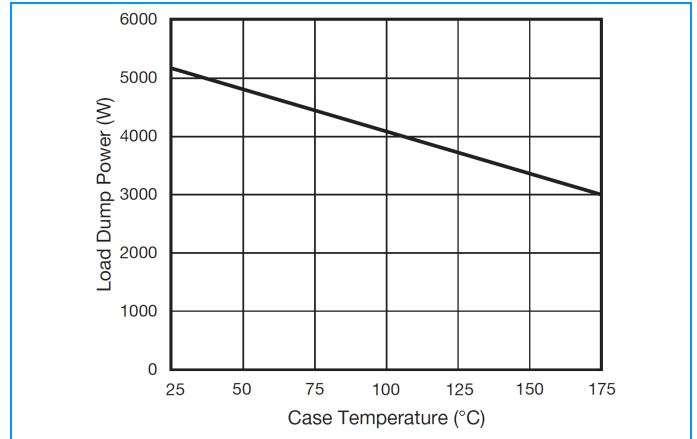

Figure 3 - Pulse Waveform

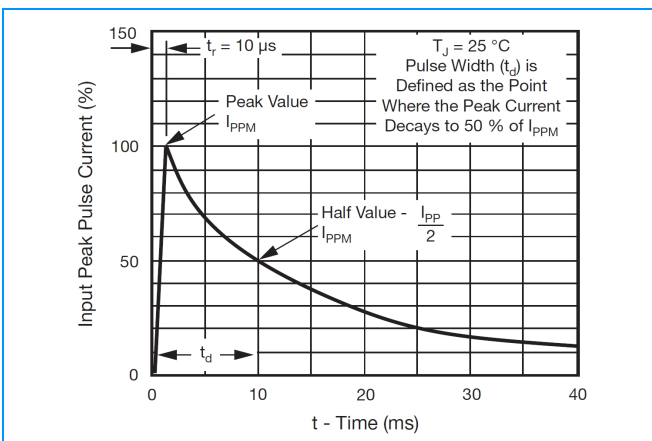

Figure 4 – Reverse Power Capability

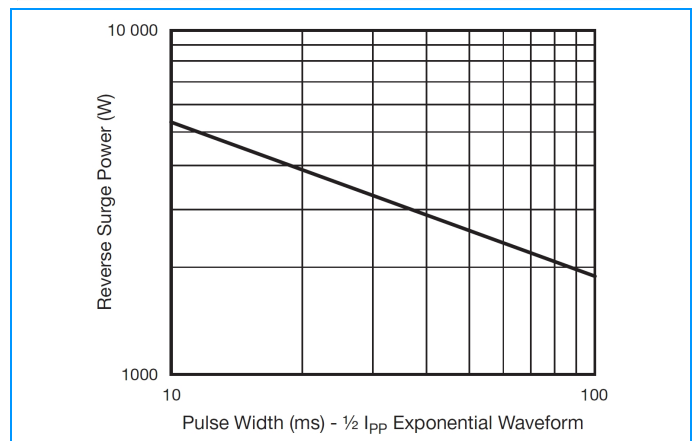

Figure 5 - Typical Transient Thermal Impedance

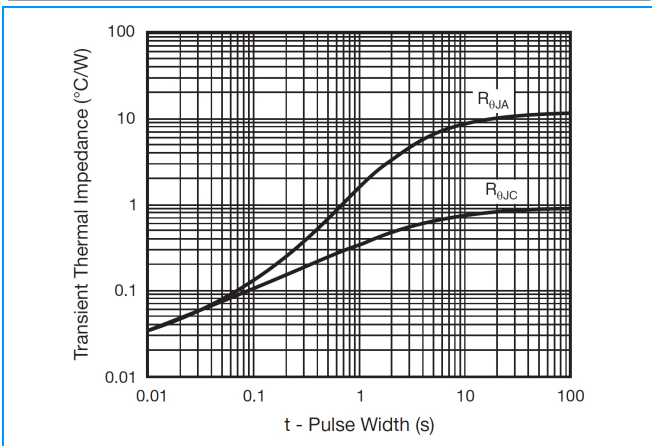
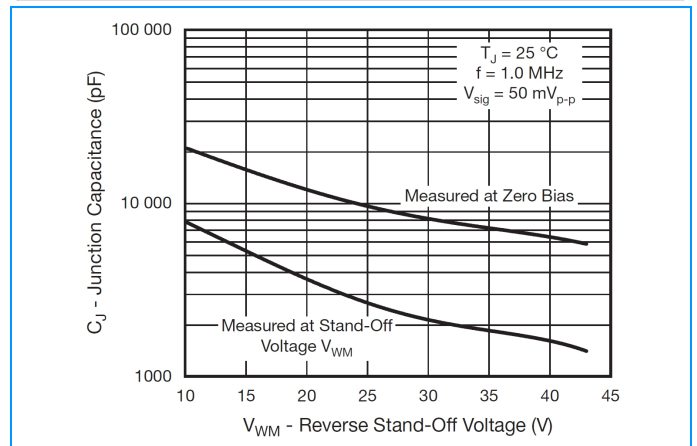

Figure 6 - Typical Junction Capacitance



Surface Mount Transient Voltage Suppressors (TVS)

SM8S Series 10 To 43 V 6600W

Mechanical Data

Case	DO-218AB Molding compound meets UL 94 V-0 flammability rating Base P/N HE3 - RoHS compliant, AEC-Q101 qualified
Polarity	Heat sink is anode
Terminal	Matte tin plated leads, solderable per J-STD-002 and JESD 22-B102 HE3 suffix meets JESD 201 class 2 whisker test

Part Numbering

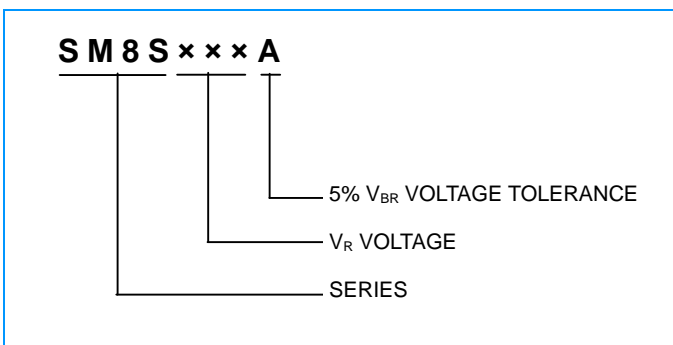

Ordering Information (Example)

Preferred P/N	Unit Weight (g)	Preferred Package Code	Base Quantity	Delivery Mode
SM8S10AHE3/2D ⁽¹⁾	2.605	2D	750	13" diameter plastic tape and reel, anode towards the sprocket hole

Note:

(1) AEC-Q101 qualified

Package Outline Dimensions Unit: inches (millimeters)

