

# SMBJ12AON

## 600 Watt Peak Power Zener Transient Voltage Suppressor

### Unidirectional\*

The SMBJ12AON is designed to protect voltage sensitive components from high voltage, high energy transients. This device has excellent clamping capability, high surge capability, low zener impedance and fast response time. The SMBJ12AON is ideally suited for use in computer hard disk drives, communication systems, automotive, numerical controls, process controls, medical equipment, business machines, power supplies, and many other industrial/consumer applications.

#### Specification Features:

- Working Peak Reverse Voltage Range – 12 V
- Peak Power – 600 Watts @ 1 ms at Maximum Clamp Voltage @ Peak Pulse Current
- ESD Rating of Class 3 (>16 KV) per Human Body Model
- ESD Rating IEC 61000 –4.2 Level 4
- Low Leakage < 5  $\mu$ A at 12 V
- UL 497B for Isolated Loop Circuit Protection
- Response Time is Typically < 1 ns
- Pb-Free Package is Available

#### Mechanical Characteristics:

**CASE:** Void-free, transfer-molded, thermosetting plastic

**FINISH:** All external surfaces are corrosion resistant and leads are readily Solderable

**MAXIMUM CASE TEMPERATURE FOR SOLDERING PURPOSES:**  
260°C for 10 Seconds

**LEADS:** Modified L-Bend providing more contact area to bond pads

**POLARITY:** Cathode indicated by polarity band

**MOUNTING POSITION:** Any

#### ABSOLUTE MAXIMUM RATINGS

Please See the Table on the Following Page



ON Semiconductor®

<http://onsemi.com>

### PLASTIC SURFACE MOUNT ZENER OVERVOLTAGE TRANSIENT SUPPRESSOR 600 WATT PEAK POWER

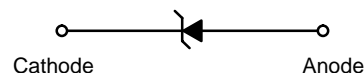

SMB  
CASE 403A  
PLASTIC

#### MARKING DIAGRAM

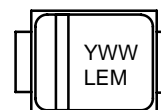

Y = Year  
WW = Work Week  
LEM = Specific Device Code

#### ORDERING INFORMATION

Device †	Package	Shipping†
SMBJ12AONT3	SMB	2500/Tape & Reel
SMBJ12AONT3G	SMB (Pb-Free)	2500/Tape & Reel

†The "T3" suffix refers to a 13 inch reel.

†For information on tape and reel specifications, including part orientation and tape sizes, please refer to our Tape and Reel Packaging Specification Brochure, BRD8011/D.

# SMBJ12AON

## ABSOLUTE MAXIMUM RATINGS

Rating	Symbol	Value	Unit
Peak Power Dissipation (Note 1) @ $T_L = 25^\circ\text{C}$ , Pulse Width = 1 ms	$P_{PK}$	600	W
DC Power Dissipation @ $T_L = 75^\circ\text{C}$ Measured Zero Lead Length (Note 2) Derate Above $75^\circ\text{C}$	$P_D$	3.0	W
Thermal Resistance from Junction to Lead	$R_{\theta JL}$	40 25	$\text{mW}/^\circ\text{C}$ $^\circ\text{C}/\text{W}$
DC Power Dissipation (Note 3) @ $T_A = 25^\circ\text{C}$ Derate Above $25^\circ\text{C}$	$P_D$	0.55	W
Thermal Resistance from Junction to Ambient	$R_{\theta JA}$	4.4 226	$\text{mW}/^\circ\text{C}$ $^\circ\text{C}/\text{W}$
Operating and Storage Temperature Range	$T_J, T_{stg}$	-65 to +150	$^\circ\text{C}$

Maximum ratings are those values beyond which device damage can occur. Maximum ratings applied to the device are individual stress limit values (not normal operating conditions) and are not valid simultaneously. If these limits are exceeded, device functional operation is not implied, damage may occur and reliability may be affected.

- 10 X 1000  $\mu\text{s}$ , non-repetitive at maximum  $I_{PPM}$  and  $V_{CM}$ , see electrical characteristics.
- 1" square copper pad, FR-4 board
- FR-4 board, using ON Semiconductor minimum recommended footprint, as shown in 403A case outline dimensions spec.

## ELECTRICAL CHARACTERISTICS ( $T_A = 25^\circ\text{C}$ unless otherwise noted, $V_F = 3.5\text{ V Max.}$ @ $I_F$ (Note 4) = 30 A)

Symbol	Parameter
$I_{PP}$	Maximum Reverse Peak Pulse Current
$V_C$	Clamping Voltage @ $I_{PP}$
$V_{RWM}$	Working Peak Reverse Voltage
$I_R$	Maximum Reverse Leakage Current @ $V_{RWM}$
$V_{BR}$	Breakdown Voltage @ $I_T$
$I_T$	Test Current
$I_F$	Forward Current
$V_F$	Forward Voltage @ $I_F$

- 1/2 sine wave (or equivalent square wave), PW = 8.3 ms, non-repetitive duty cycle.

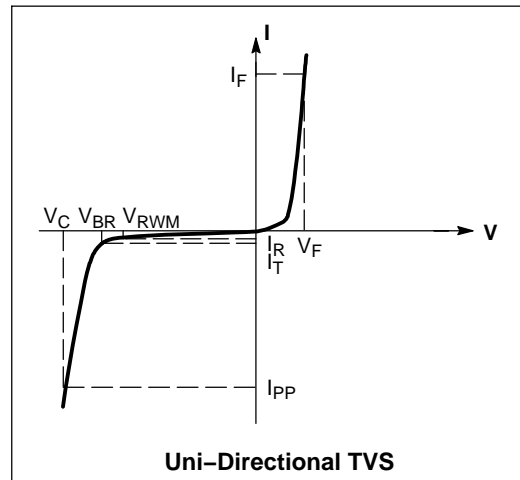

## ELECTRICAL CHARACTERISTICS ( $T_J = 25^\circ\text{C}$ unless otherwise noted)

Parameter	Conditions	Symbol	Min	Typ	Max	Unit
Zener Voltage (Note 5)	$I_T = 1\text{ mA}$	$V_Z$	13.2	13.75	14.3	V
Reverse Leakage Current	$V_{RWM} = 12\text{ V}$	$I_R$			5.0	$\mu\text{A}$
Clamping Voltage	$I_{PP} = 17.5\text{ A}$ (Per Figures 1 & 2)	$V_C$			15.6	V
Absolute Maximum Clamping Voltage	$I_{PPM} = 30.2\text{ A}$ (Per Figure 3, Note 6)	$V_{CM}$			19.9	V

- $V_Z$  measured at pulse test  $I_T$  at an ambient temperature of  $25^\circ\text{C}$ .
- Absolute Maximum Peak Current,  $I_{PPM}$ .

# SMBJ12AON

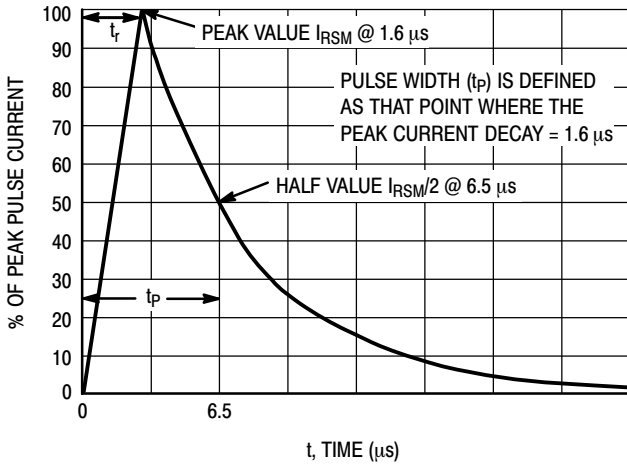

Figure 1. 1.6  $\times$  6.5  $\mu s$  Pulse Waveform

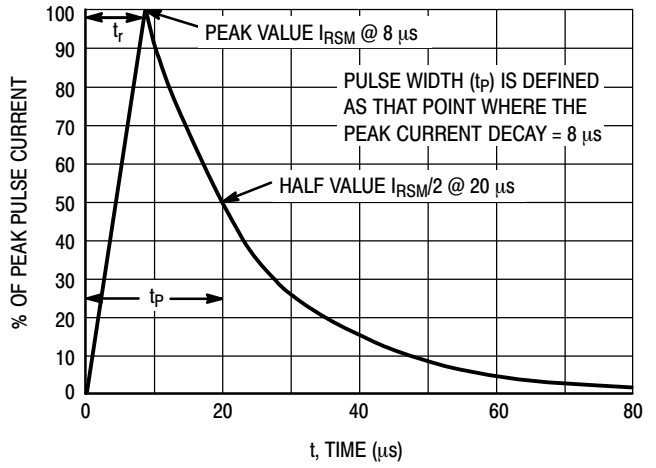

Figure 2. 8  $\times$  20  $\mu s$  Pulse Waveform

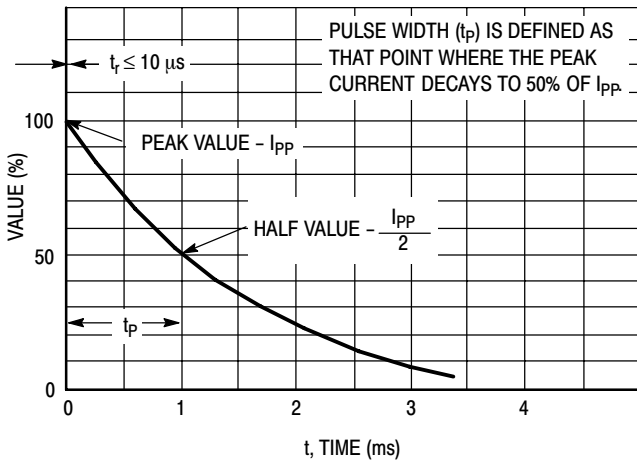

Figure 3. 10  $\times$  1000  $\mu s$  Pulse Waveform

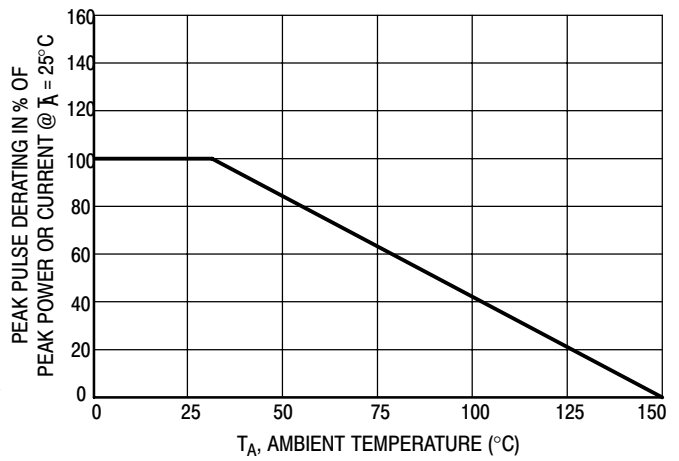
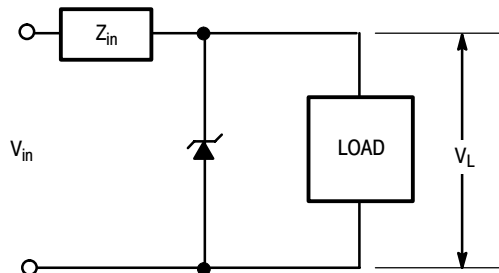

Figure 4. Pulse Derating Curve

## TYPICAL PROTECTION CIRCUIT



# SMBJ12AON

## APPLICATION NOTES

### RESPONSE TIME

In most applications, the transient suppressor device is placed in parallel with the equipment or component to be protected. In this situation, there is a time delay associated with the capacitance of the device and an overshoot condition associated with the inductance of the device and the inductance of the connection method. The capacitive effect is of minor importance in the parallel protection scheme because it only produces a time delay in the transition from the operating voltage to the clamp voltage as shown in Figure 5.

The inductive effects in the device are due to actual turn-on time (time required for the device to go from zero current to full current) and lead inductance. This inductive effect produces an overshoot in the voltage across the equipment or component being protected as shown in Figure 6. Minimizing this overshoot is very important in the application, since the main purpose for adding a transient suppressor is to clamp voltage spikes. The SMB series have

a very good response time, typically  $< 1$  ns and negligible inductance. However, external inductive effects could produce unacceptable overshoot. Proper circuit layout, minimum lead lengths and placing the suppressor device as close as possible to the equipment or components to be protected will minimize this overshoot.

Some input impedance represented by  $Z_{in}$  is essential to prevent overstress of the protection device. This impedance should be as high as possible, without restricting the circuit operation.

### DUTY CYCLE DERATING

If the duty cycle increases, the peak power must be reduced as indicated by the curves of Figure 7. Average power must be derated as the lead or ambient temperature rises above  $25^{\circ}\text{C}$ . The average power derating curve normally given on data sheets may be normalized and used for this purpose.

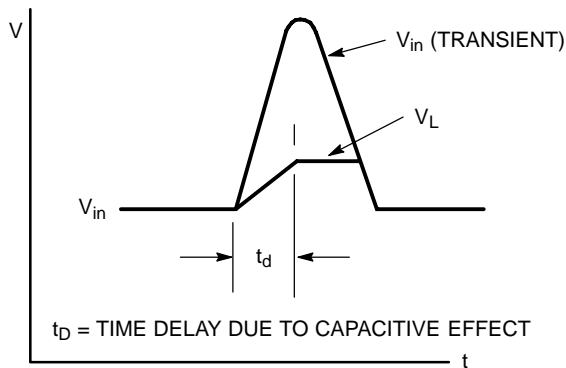

Figure 5.

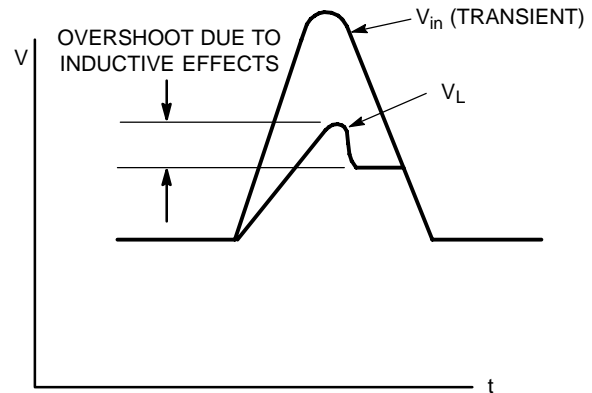

Figure 6.

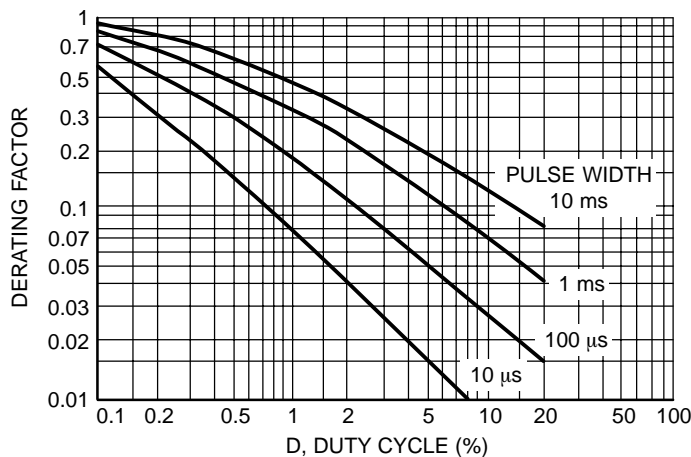

Figure 7. Typical Derating Factor for Duty Cycle

# SMBJ12AON

## UL RECOGNITION

The entire series has *Underwriters Laboratory Recognition* for the classification of protectors (QVGV2) under the UL standard for safety 497B and File #116110. Many competitors only have one or two devices recognized or have recognition in a non-protective category. Some competitors have no recognition at all. With the UL497B recognition, our parts successfully passed several tests

including Strike Voltage Breakdown test, Endurance Conditioning, Temperature test, Dielectric Voltage-Withstand test, Discharge test and several more.

Whereas, some competitors have only passed a flammability test for the package material, we have been recognized for much more to be included in their Protector category.

# SMBJ12AON

## PACKAGE DIMENSIONS

SMB  
DO-214AA  
CASE 403A-03  
ISSUE D

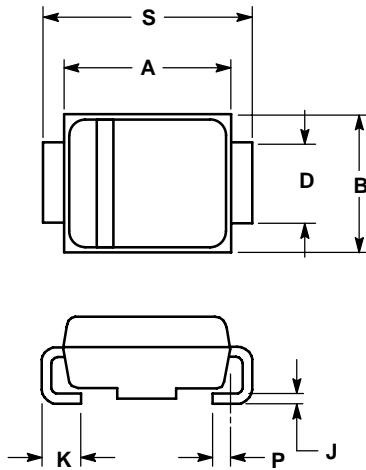

- NOTES:
1. DIMENSIONING AND TOLERANCING PER ANSI Y14.5M, 1982.
  2. CONTROLLING DIMENSION: INCH.
  3. D DIMENSION SHALL BE MEASURED WITHIN DIMENSION P.

DIM	INCHES		MILLIMETERS	
	MIN	MAX	MIN	MAX
A	0.160	0.180	4.06	4.57
B	0.130	0.150	3.30	3.81
C	0.075	0.095	1.90	2.41
D	0.077	0.083	1.96	2.11
H	0.0020	0.0060	0.051	0.152
J	0.006	0.012	0.15	0.30
K	0.030	0.050	0.76	1.27
P	0.020 REF		0.51 REF	
S	0.205	0.220	5.21	5.59

### SOLDERING FOOTPRINT\*

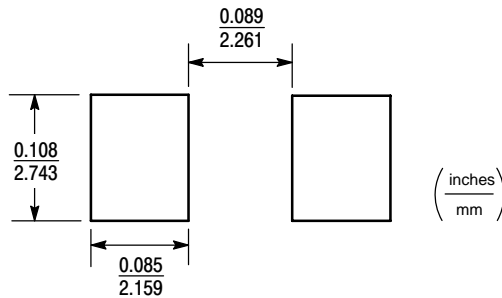

\*For additional information on our Pb-Free strategy and soldering details, please download the ON Semiconductor Soldering and Mounting Techniques Reference Manual, SOLDERRM/D.

ON Semiconductor and  are registered trademarks of Semiconductor Components Industries, LLC (SCILLC). SCILLC reserves the right to make changes without further notice to any products herein. SCILLC makes no warranty, representation or guarantee regarding the suitability of its products for any particular purpose, nor does SCILLC assume any liability arising out of the application or use of any product or circuit, and specifically disclaims any and all liability, including without limitation special, consequential or incidental damages. "Typical" parameters which may be provided in SCILLC data sheets and/or specifications can and do vary in different applications and actual performance may vary over time. All operating parameters, including "Typicals" must be validated for each customer application by customer's technical experts. SCILLC does not convey any license under its patent rights nor the rights of others. SCILLC products are not designed, intended, or authorized for use as components in systems intended for surgical implant into the body, or other applications intended to support or sustain life, or for any other application in which the failure of the SCILLC product could create a situation where personal injury or death may occur. Should Buyer purchase or use SCILLC products for any such unintended or unauthorized application, Buyer shall indemnify and hold SCILLC and its officers, employees, subsidiaries, affiliates, and distributors harmless against all claims, costs, damages, and expenses, and reasonable attorney fees arising out of, directly or indirectly, any claim of personal injury or death associated with such unintended or unauthorized use, even if such claim alleges that SCILLC was negligent regarding the design or manufacture of the part. SCILLC is an Equal Opportunity/Affirmative Action Employer. This literature is subject to all applicable copyright laws and is not for resale in any manner.

### PUBLICATION ORDERING INFORMATION

**LITERATURE FULFILLMENT:**  
Literature Distribution Center for ON Semiconductor  
P.O. Box 61312, Phoenix, Arizona 85082-1312 USA  
**Phone:** 480-829-7710 or 800-344-3860 Toll Free USA/Canada  
**Fax:** 480-829-7709 or 800-344-3867 Toll Free USA/Canada  
**Email:** orderlit@onsemi.com

**N. American Technical Support:** 800-282-9855 Toll Free  
USA/Canada

**Japan:** ON Semiconductor, Japan Customer Focus Center  
2-9-1 Kamimeguro, Meguro-ku, Tokyo, Japan 153-0051  
**Phone:** 81-3-5773-3850

**ON Semiconductor Website:** <http://onsemi.com>

**Order Literature:** <http://www.onsemi.com/litorder>

For additional information, please contact your local Sales Representative.