

SMDD-110H

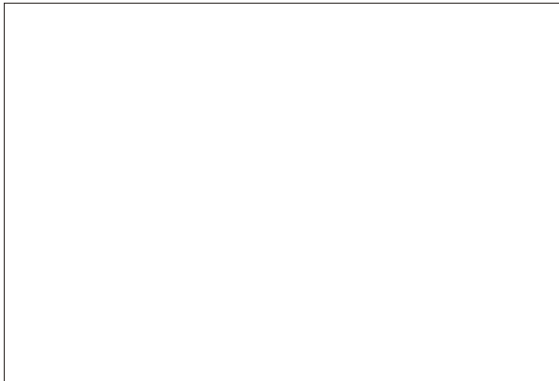

Diode-Diode Module



Type	V_{RSM}	V_{RRM}
SMDD-110H-08	1000	800
SMDD-110H-12	1400	1200
SMDD-110H-14	1600	1400
SMDD-110H-16	1800	1600
SMDD-110H-18	2000	1800
SMDD-110H-20	2200	2000
SMDD-110H-22	2400	2200
SMDD-110H-24	2600	2400

Type	I_{FAVM}	I_{FRMS}	T_c	I_{FSM}	i^2t	V_{TM}	I_{FM}	V_{FO}	r_F	T_{VJM}	V_{isol}	R_{thJC}
	A	A	°C	KA	KA ² s	V	A	V	mΩ	°C	V	K/W
SMDD-110H	110	173	100	2.6	23	1.45	330	0.8	2.2	150	2500	0.35

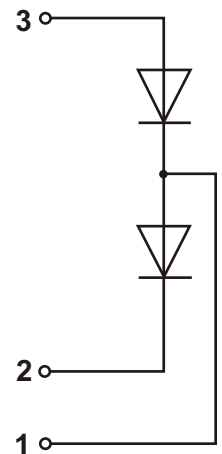
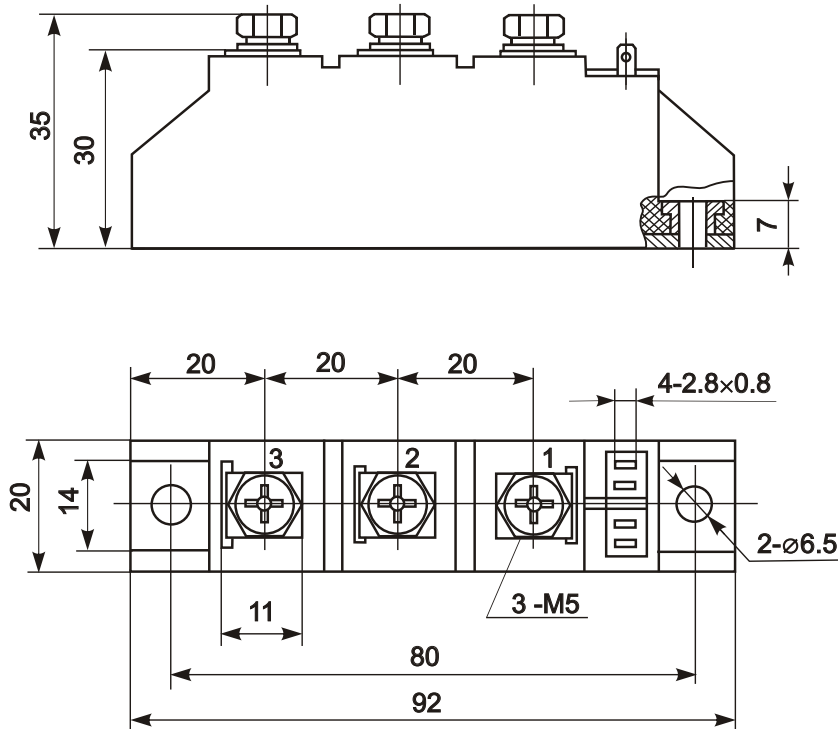

Features:

- Industrial standard package
- Heat transfer through aluminium nitride ceramic isolated metal baseplate
- Precise internal pressure contacts for high reliability
- 2500V RMS isolation voltage

Typical Applications:

- DC power supply for instrument and equipment
- Power converters
- Electronic welders
- Lighting control