

DATA SHEET

SMP1345 Series: Very Low Capacitance Plastic Packaged Silicon PIN Diodes

Features

- Designed for high isolation LNB, WLAN and wireless switch applications
- Very low insertion loss (0.4 dB)
- 0.15 pF capacitance
- Available lead (Pb)-free MSL-1 @ 250 °C per JEDEC J-STD-020
- Available in tape and reel packaging



Description

The SMP1345 series of plastic packaged, surface mountable PIN diodes is designed for high volume LNB, WLAN and switch applications from 10 MHz to 6 GHz. The short carrier lifetime of typically 100 ns, combined with its thin I region width of nominally, 10 μm , results in a fast speed RF switching PIN diode. The RF performance of the SMP1345 series is assured by virtue of its very low capacitance (0.15 pF) and low resistance (1.5 Ω at 10 mA).

The SMP1345-518 has been specifically designed for WLAN 802.11 a, b, and g applications. It is ideally used for diversity switch applications.

NEW Skyworks offers lead (Pb)-free “environmentally friendly” packaging that is RoHS compliant (European Parliament for the Restriction of Hazardous Substances).









Absolute Maximum Ratings

Characteristic	Value
Reverse voltage (V_R)	50 V
Power dissipation @ 25 °C lead temperature (P_D)	250 mW
Storage temperature (T_{ST})	-65 °C to +150 °C
Operating temperature (T_{OP})	-65 °C to +150 °C
ESD human body model	Class 1B

Performance is guaranteed only under the conditions listed in the specifications table and is not guaranteed under the full range(s) described by the Absolute Maximum specifications. Exceeding any of the absolute maximum/minimum specifications may result in permanent damage to the device and will void the warranty.

CAUTION: Although this device is designed to be as robust as possible, Electrostatic Discharge (ESD) can damage this device. This device must be protected at all times from ESD. Static charges may easily produce potentials of several kilovolts on the human body or equipment, which can discharge without detection. Industry-standard ESD precautions must be employed at all times.

				
Common Anode	Common Cathode	Series Pair	Single	Ring
SOT-23	SOT-23	SOT-23	SC-79	LGA
SMP1345-003 Marking: PU9	SMP1345-004 Marking: PU3	SMP1345-005 Marking: PU2	SMP1345-079	SMP1345-518 Lead (Pb)-Free Marking: 0
SMP1345-003LF Marking: RU9	SMP1345-004LF Marking: RU3	SMP1345-005LF Marking: RU2	SMP1345-079LF	
$L_S = 1.5 \text{ nH}$	$L_S = 1.5 \text{ nH}$	$L_S = 1.5 \text{ nH}$	$L_S = 0.7 \text{ nH}$	$L_S = 0.6 \text{ nH}$

 LF denotes lead (Pb)-free packaging option as an alternative to our standard tin/lead (Sn/Pb) packaging.

Electrical Specifications at 25 °C

Parameter	Condition	Typ.	Max.	Unit
Reverse current (I_R)	$V_R = 50 \text{ V}$		10	μA
Capacitance (C_T)	$F = 1 \text{ MHz}, V = 1 \text{ V}$	0.19		pF
Capacitance (C_T)	$F = 1 \text{ MHz}, V = 5 \text{ V}$	0.18	0.20	pF
Resistance (R_S)	$F = 100 \text{ MHz}, I = 1 \text{ mA}$	3.50		Ω
Resistance (R_S)	$F = 100 \text{ MHz}, I = 10 \text{ mA}$	1.50	2.00	Ω
Forward voltage (V_F)	$I_F = 10 \text{ mA}$	0.89		V
Carrier lifetime (TI)	$I_F = 10 \text{ mA}$	100		ns
I region width		10		μm

Typical Performance Data

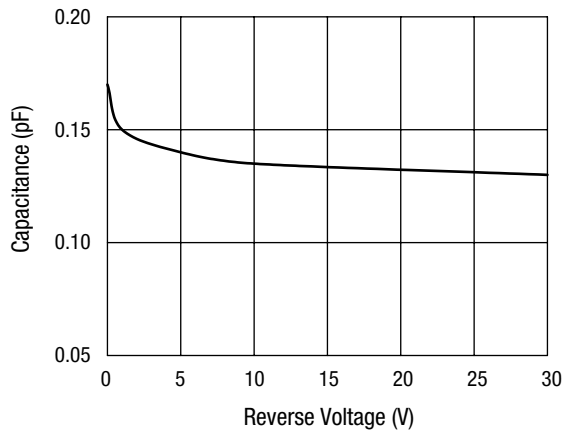

**Total Capacitance vs. Reverse Voltage
Measured in an SC-79 Package**

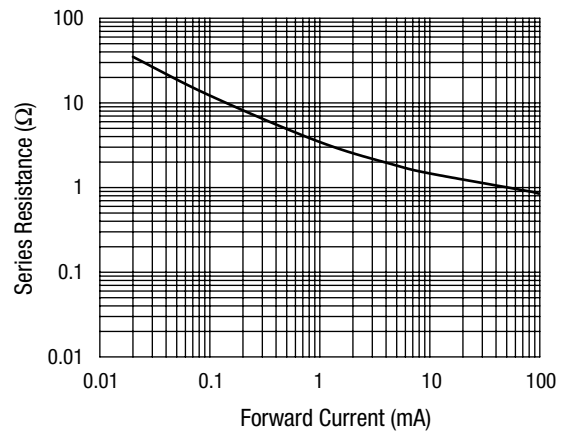

Series Resistance vs. Current @ 100 MHz

Truth Table

CTR1	CTR2	Low Loss Paths
3.3 V	0 V	RF1-RF4 RF2-RF3
0 V	3.3 V	RF1-RF3 RF2-RF4

WLAN Application Circuit for DPDT Diversity Switch Using SMP1345-518

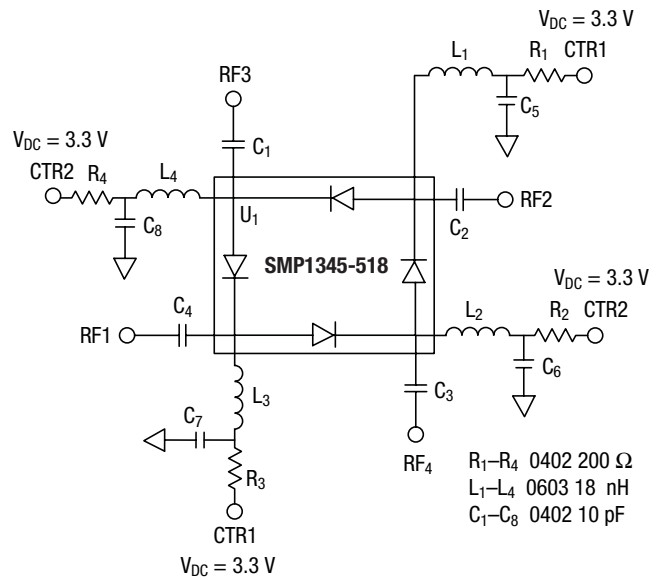

Bridge Switch Schematic

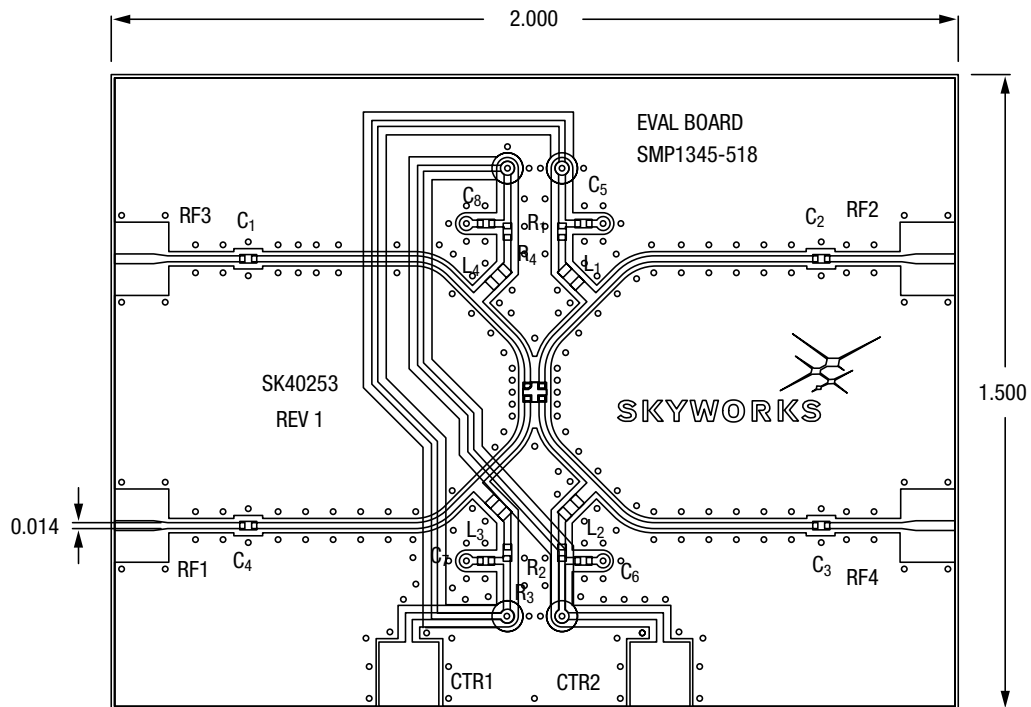

Evaluation Board

Typical Performance Data For SMP1345-518

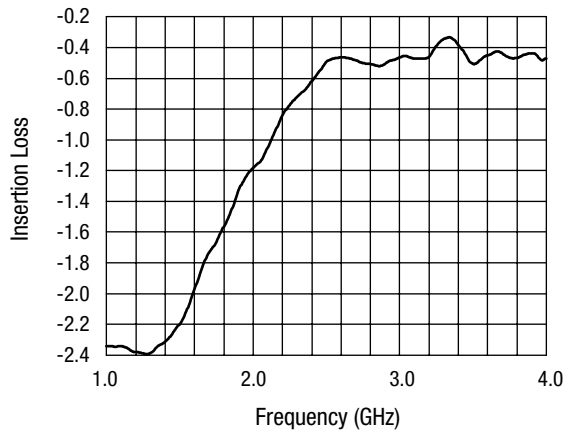

Insertion Loss vs. Frequency

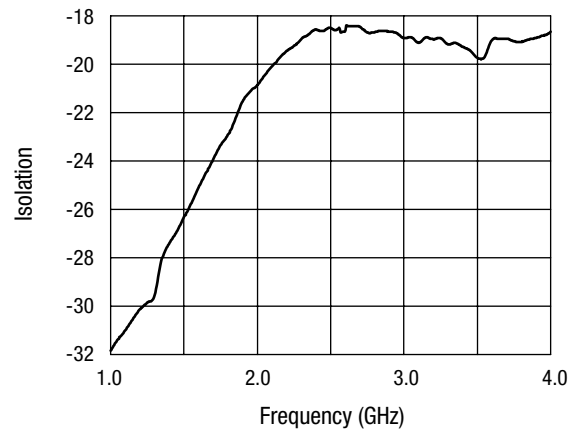

Isolation vs. Frequency

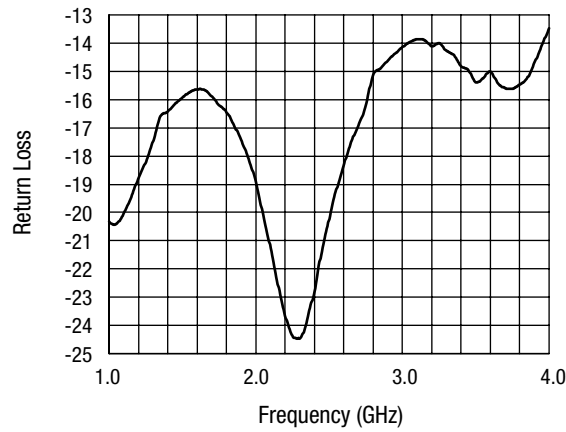

Return Loss vs. Frequency

Recommended Solder Reflow Profiles

Refer to the "Recommended Solder Reflow Profile" Application Note.

SC-79

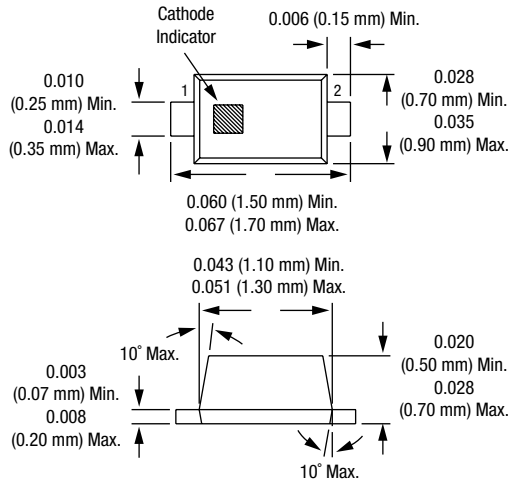

LGA

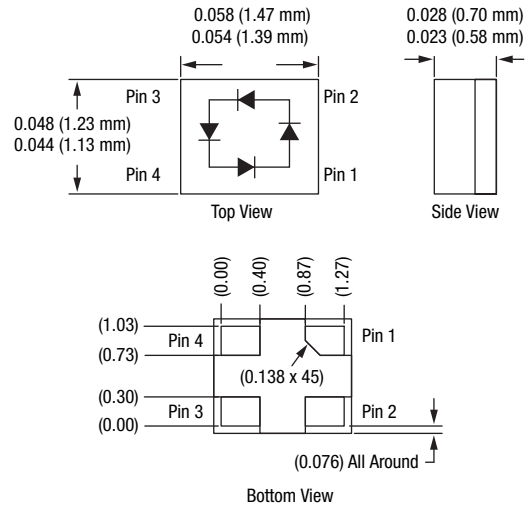

SOT-23

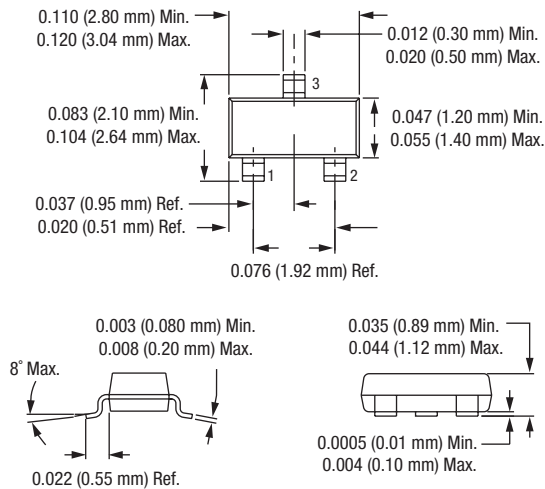

Copyright © 2002, 2003, 2004, 2005, Skyworks Solutions, Inc. All Rights Reserved.

Information in this document is provided in connection with Skyworks Solutions, Inc. ("Skyworks") products. These materials are provided by Skyworks as a service to its customers and may be used for informational purposes only by the customer. Skyworks assumes no responsibility for errors or omissions in these materials. Skyworks may make changes to its documentation, products, specifications and product descriptions at any time, without notice. Skyworks makes no commitment to update the information and shall have no responsibility whatsoever for conflicts, incompatibilities, or other difficulties arising from future changes to its documentation, products, specifications and product descriptions.

No license, express or implied, by estoppel or otherwise, to any intellectual property rights is granted by or under this document. Except as may be provided in Skyworks Terms and Conditions of Sale for such products, Skyworks assumes no liability whatsoever in association with its documentation, products, specifications and product descriptions.

THESE MATERIALS ARE PROVIDED "AS IS" WITHOUT WARRANTY OF ANY KIND, EITHER EXPRESS OR IMPLIED OR OTHERWISE, RELATING TO SALE AND/OR USE OF SKYWORKS PRODUCTS INCLUDING WARRANTIES RELATING TO FITNESS FOR A PARTICULAR PURPOSE, MERCHANTABILITY, PERFORMANCE, QUALITY OR NON-INFRINGEMENT OF ANY PATENT, COPYRIGHT OR OTHER INTELLECTUAL PROPERTY RIGHT. SKYWORKS FURTHER DOES NOT WARRANT THE ACCURACY OR COMPLETENESS OF THE INFORMATION, TEXT, GRAPHICS OR OTHER ITEMS CONTAINED WITHIN THESE MATERIALS. SKYWORKS SHALL NOT BE LIABLE FOR ANY DAMAGES, INCLUDING SPECIAL, INDIRECT, INCIDENTAL, OR CONSEQUENTIAL DAMAGES, INCLUDING WITHOUT LIMITATION, LOST REVENUES OR LOST PROFITS THAT MAY RESULT FROM THE USE OF THESE MATERIALS WHETHER OR NOT THE RECIPIENT OF MATERIALS HAS BEEN ADVISED OF THE POSSIBILITY OF SUCH DAMAGE.

Skyworks products are not intended for use in medical, lifesaving or life-sustaining applications. Skyworks customers using or selling Skyworks products for use in such applications do so at their own risk and agree to fully indemnify Skyworks for any damages resulting from such improper use or sale.

The following are trademarks of Skyworks Solutions, Inc.: Skyworks®, the Skyworks logo, and Breakthrough Simplicity®. Product names or services listed in this publication are for identification purposes only, and may be trademarks of Skyworks or other third parties. Third-party brands and names are the property of their respective owners. Additional information, posted at www.skyworksinc.com, is incorporated by reference.