



SMP30-xxx

TELECOM EQUIPMENT PROTECTION: TRISIL™

FEATURES

- Bidirectional crowbar protection
- Voltage range from 62V to 270V
- Low capacitance from 12pF to 20pF typ. @ 50V
- Low leakage current: $I_R = 2\mu\text{A}$ max.
- Holding current: $I_H = 150$ mA min.
- Repetitive peak pulse current:
 $I_{PP} = 30$ A (10/1000 μs)

MAIN APPLICATIONS

Telecommunication equipment such as

- Analog and digital line cards (xDSL, T1/E1, ISDN...).
- Terminals (phone, fax, modem...) and central office equipment.

DESCRIPTION

The SMP30-xxx series has been designed to protect telecommunication equipment against lightning and transient induced by AC power lines.

The package / die size ratio has been optimized by using the SMA package.

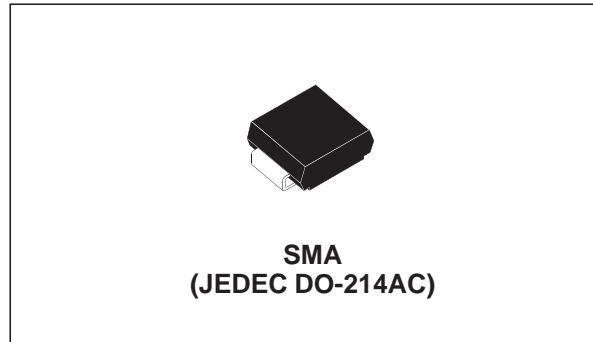

SCHEMATIC DIAGRAM

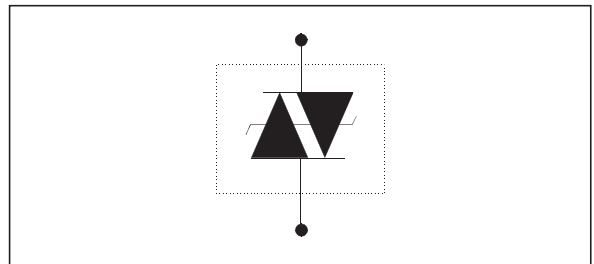

BENEFITS

Trisils are not subject to ageing and provide a fail safe mode in short circuit for a better protection. Trisils are used to help equipment to meet various standards such as UL1950, IEC950 / CSA C22.2, UL1459 and FCC part 68. Trisils have UL94 V0 resin approved. SMA package is JEDEC registered. (Trisils are UL 497B approved - file: E136224).

SMP30-xxx

IN COMPLIANCES WITH THE FOLLOWING STANDARDS

Standard	Peak Surge Voltage (V)	Voltage Waveform (μ s)	Required peak current (A)	Current Waveform (μ s)	Minimum serial resistor to meet standard (Ω)
GR-1089 Core First level	2500	2/10	500	2/10	20
	1000	10/1000	100	10/1000	24
GR-1089 Core Second level	5000	2/10	500	2/10	40
GR-1089 Core Intra-building	1500	2/10	100	2/10	0
ITU-T-K20 / K21	6000 1500	10/700	150 37.5	5/310	110 0
ITU-T-K20 (IEC61000-4-2)	6000 8000	1/60 ns	ESD contact discharge ESD air discharge		0 0
VDE0433	4000	10/700	100	5/310	60
	2000		50		10
VDE0878	4000	1.2/50	100	1/20	18
	2000		50		0
IEC61000-4-5	4000	10/700	100	5/310	60
	4000	1.2/50	100	8/20	18
FCC Part 68, lightning surge type A	1500	10/160	200	10/160	26
	800	10/560	100	10/560	15
FCC Part 68, lightning surge type B	1000	9/720	25	5/320	0

THERMAL RESISTANCES

Symbol	Parameter	Value	Unit
$R_{th(j-a)}$	Junction to ambient with recommended footprint	120	$^{\circ}\text{C}/\text{W}$
$R_{th(j-l)}$	Junction to leads	30	$^{\circ}\text{C}/\text{W}$

ELECTRICAL CHARACTERISTICS

($T_{amb} = 25^{\circ}\text{C}$)

Symbol	Parameter
V_{RM}	Stand-off voltage
I_{RM}	Leakage current at V_{RM}
V_R	Continuous reverse voltage
V_{BR}	Breakdown voltage
V_{BO}	Breakover voltage
I_H	Holding current
I_{BO}	Breakover current
I_{PP}	Peak pulse current
C	Capacitance

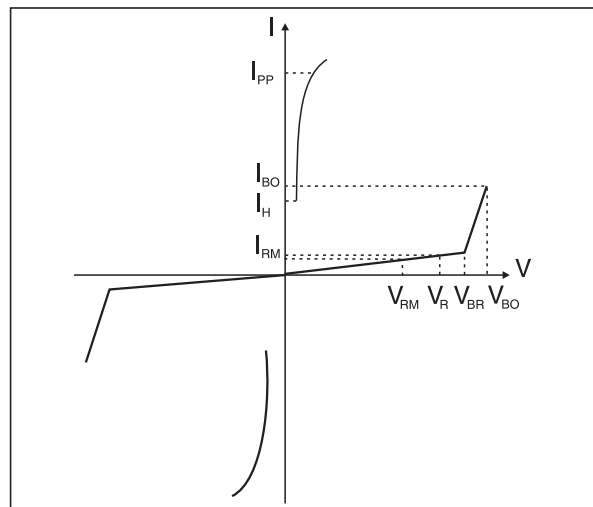

ABSOLUTE RATINGS ($T_{amb} = 25^{\circ}\text{C}$)

Symbol	Parameter		Value	Unit
I_{PP}	Repetitive peak pulse current:	10/1000 μs	30	A
		8/20 μs	70	
		10/560 μs	35	
		5/310 μs	40	
		10/160 μs	45	
		1/20 μs	70	
		2/10 μs	100	
I_{FS}	Fail safe mode: maximum current	8/20 μs	2.5	kA
I_{TSM}	Non repetitive surge peak on-state current (Sinusoidal)	t = 20ms	15	A
		t = 16.6ms	17	
		t = 0.2s	8.5	
		t = 2s	4.5	
I^2t	I^2t value for fusing	t = 16.6ms	2.1	A^2s
		t = 20ms	2.25	
T_L	Maximum lead temperature for soldering during 10 s.		260	$^{\circ}\text{C}$
T_{stg} T_j	Storage temperature range		- 55 to + 150	$^{\circ}\text{C}$
	Maximum junction temperature		150	$^{\circ}\text{C}$

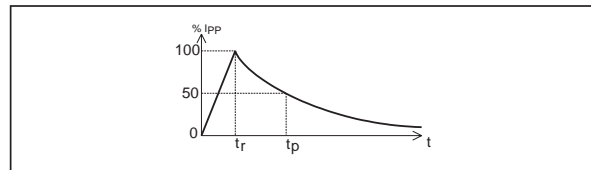
Repetitive peak pulse currenttr: rise time (μs)tp: pulse duration time (μs)ex: Pulse waveform 10/1000 μs tr = 10 μs tp = 1000 μs 

SMP30-xxx

ELECTRICAL PARAMETERS (Tamb = 25°C)

Type	IRM @ VRM max		IR @ VR MAX		DYNAMIC VBO @ IBO max		STATIC VBO @ IBO max		IH min	C typ.	C typ.
	μA	V	μA	V	V	mA	V	mA	mA	pF	pF
SMP30-62	2	56	50	62	85	800	82	800	150	20	40
SMP30-68		61		68	93		90		150	20	40
SMP30-100		90		100	135		133		150	16	35
SMP30-120		108		120	160		160		150	16	30
SMP30-130		117		130	173		173		150	14	30
SMP30-180		162		180	235		240		150	14	25
SMP30-200		180		200	262		267		150	12	25
SMP30-220		198		220	285		293		150	12	25
SMP30-240		216		240	300		320		150	12	25
SMP30-270		243		270	350		360		150	12	25

Note 1: IR measured at VR guarantee VBRmin ≥ VR

Note 2: See functional breakover voltage test circuit 1.

Note 3: See test circuit 2.

Note 4: See functional holding current test circuit 3.

Note 5: VR = 50V bias, VRMS = 1V, F = 1MHz.

Note 6: VR = 2V bias, VRMS = 1V, F = 1MHz

Fig. 1: Non repetitive surge peak on-state current versus overload duration (Tj initial = 25°C)

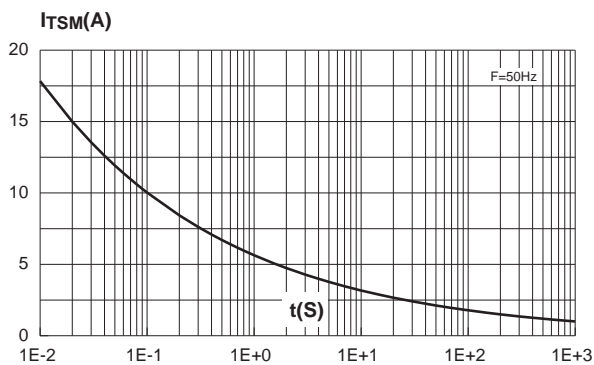

Fig. 2: On-state voltage versus on-state current (typical values).

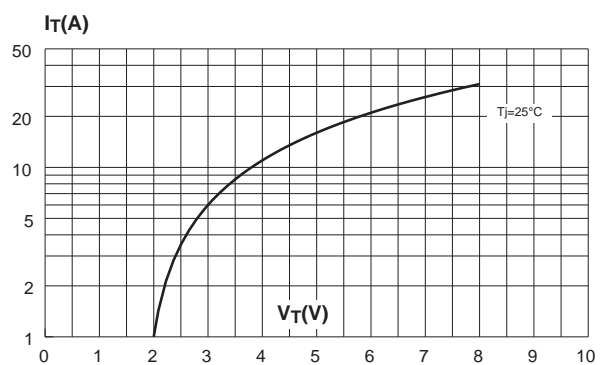

Fig. 3: Relative variation of holding current versus junction temperature.

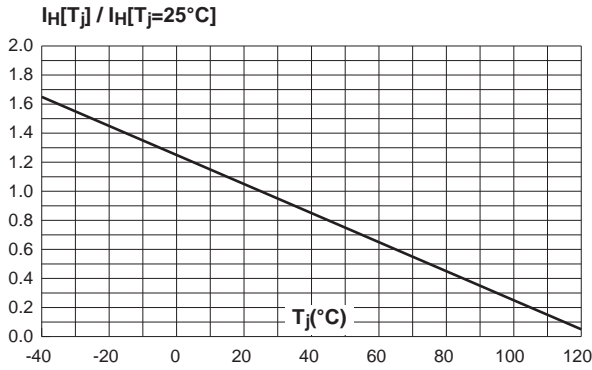

Fig. 4: Relative variation of breakover voltage versus junction temperature.

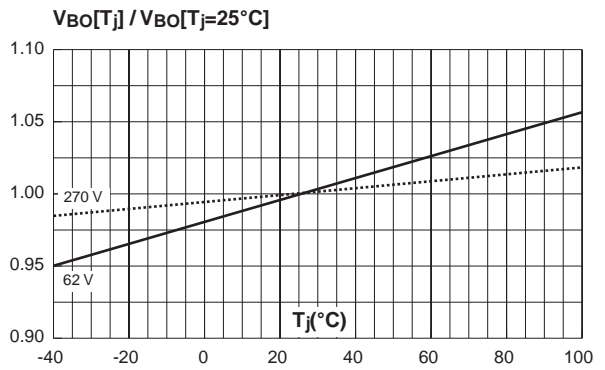

Fig. 5: Relative variation of leakage current versus junction temperature (typical values).

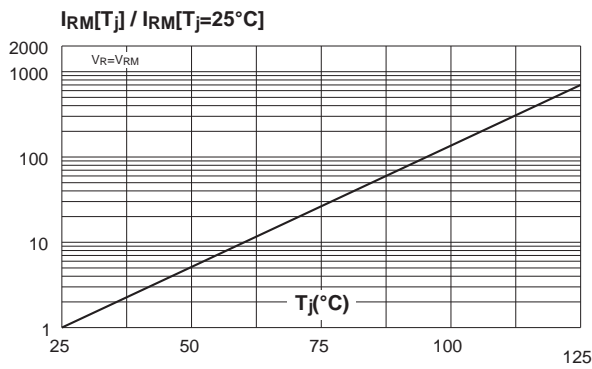

Fig. 6: Relative variation of thermal impedance versus pulse duration.

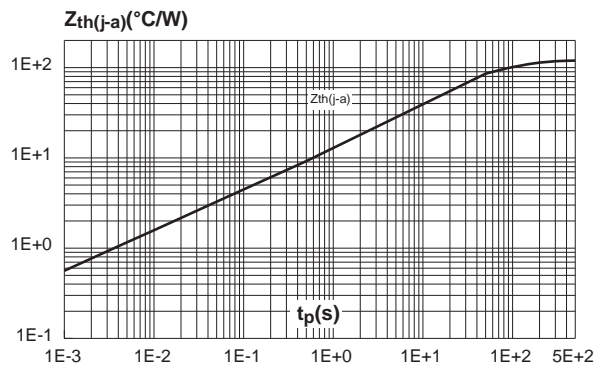
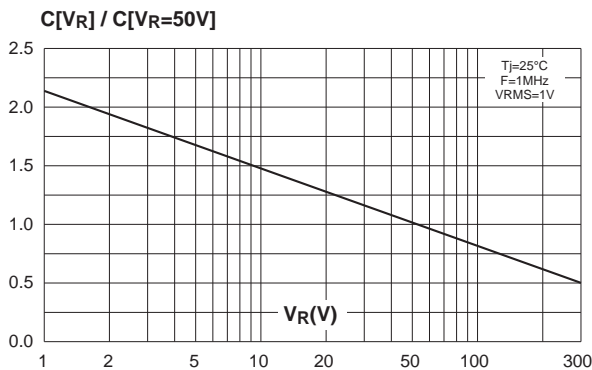
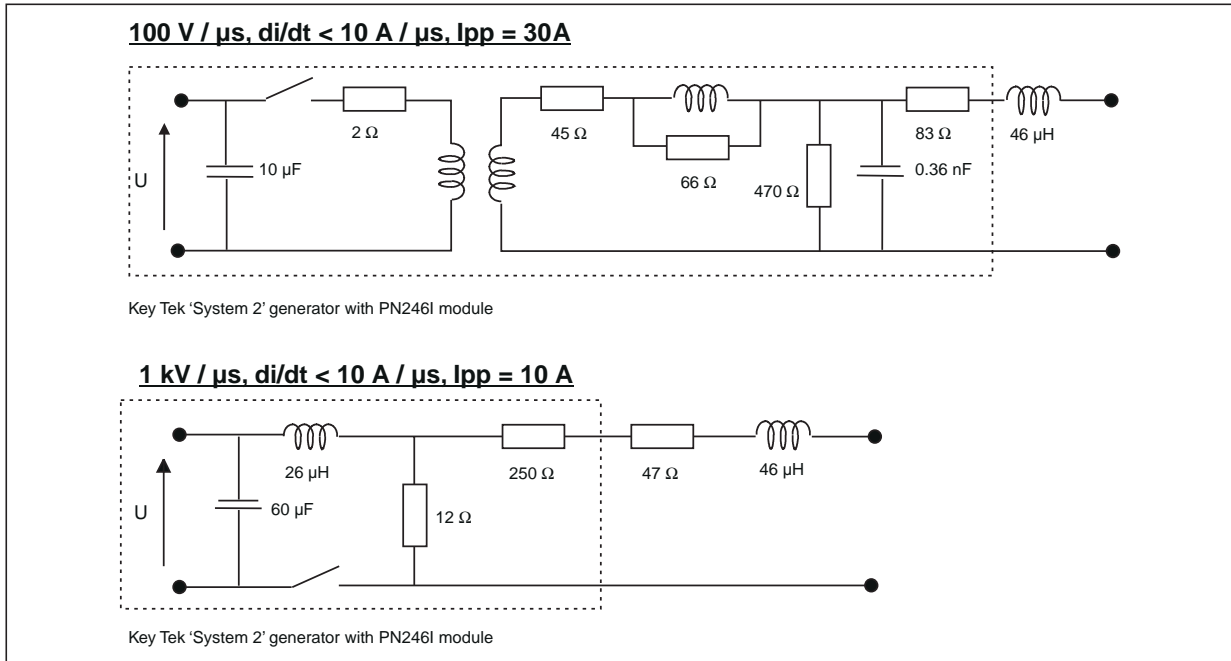

Fig. 7: Relative variation of junction capacitance versus reverse voltage applied (typical values).



TEST CIRCUIT 1 FOR DYNAMIC I_{BO} and V_{BO} PARAMETERS



TEST CIRCUIT 2 for I_{BO} AND V_{BO} PARAMETERS.

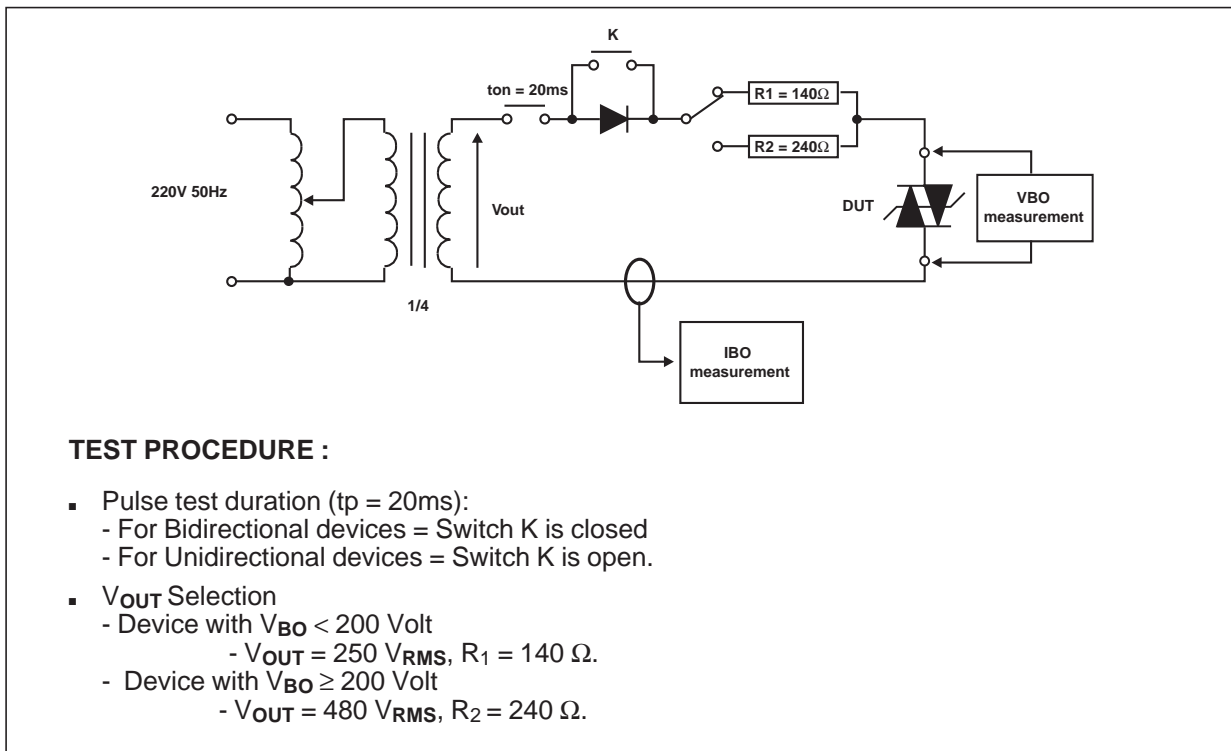

TEST CIRCUIT 3 for I_H PARAMETERS.

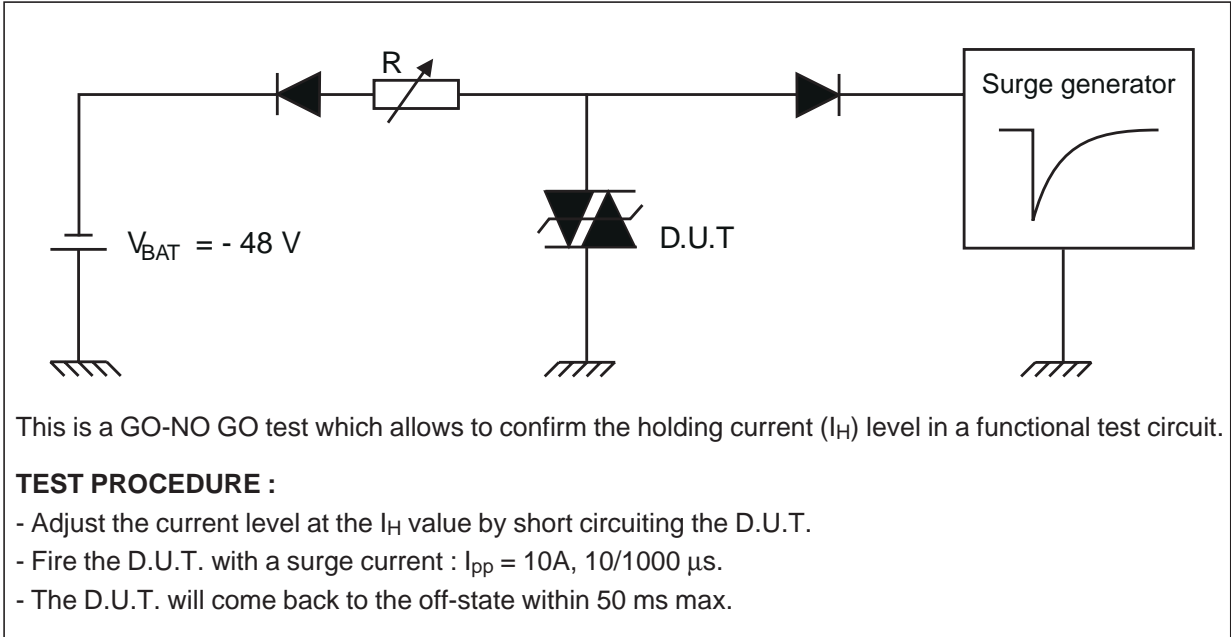

PACKAGE MECHANICAL DATA
SMA (JEDEC DO-214AC)

REF.	DIMENSIONS			
	Millimeters		Inches	
	Min.	Max.	Min.	Max.
A1	1.90	2.70	0.075	0.106
A2	0.05	0.20	0.002	0.008
b	1.25	1.65	0.049	0.065
c	0.15	0.41	0.006	0.016
E	4.80	5.60	0.189	0.220
E1	3.95	4.60	0.156	0.181
D	2.25	2.95	0.089	0.116
L	0.75	1.60	0.030	0.063

FOOT PRINT in millimeters (in inches)

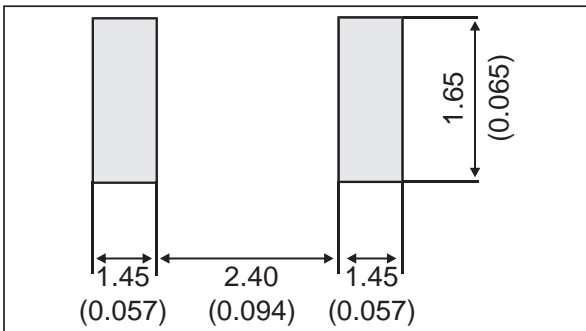

SMP30-xxx

ORDER CODE

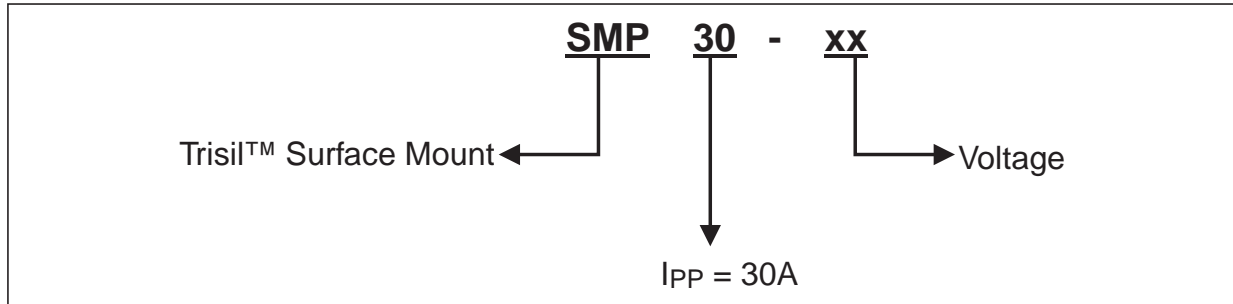

ORDERING INFORMATION

Part number	Marking	Package	Weight	Base qty	Delivery mode
SMP30-62	QA4	SMA	0.06 g	5000	Tape & reel
SMP30-68	QAB				
SMP30-100	QAC				
SMP30-120	QAD				
SMP30-130	QAE				
SMP30-180	QAF				
SMP30-200	QAG				
SMP30-220	QAH				
SMP30-240	QAI				
SMP30-270	QAJ				

Information furnished is believed to be accurate and reliable. However, STMicroelectronics assumes no responsibility for the consequences of use of such information nor for any infringement of patents or other rights of third parties which may result from its use. No license is granted by implication or otherwise under any patent or patent rights of STMicroelectronics. Specifications mentioned in this publication are subject to change without notice. This publication supersedes and replaces all information previously supplied. STMicroelectronics products are not authorized for use as critical components in life support devices or systems without express written approval of STMicroelectronics.

The ST logo is a registered trademark of STMicroelectronics
 © 2002 STMicroelectronics - Printed in Italy - All rights reserved.
 STMicroelectronics GROUP OF COMPANIES
 Australia - Brazil - Canada - China - Finland - France - Germany
 Hong Kong - India - Israel - Italy - Japan - Malaysia - Malta - Morocco - Singapore
 Spain - Sweden - Switzerland - United Kingdom - United States.

<http://www.st.com>

