

SMTD-200



Thyristor-Diode Module



Type	V_{RSM}	V_{RRM} , V_{DRM}
SMTD-200-08	900	800
SMTD-200-12	1300	1200
SMTD-200-14	1500	1400
SMTD-200-16	1700	1600
SMTD-200-18	1900	1800

Type	I_{TAVM} , I_{FAVM}	I_{TRMS} , I_{FRMS}	T_c	I_{TSM} , I_{FSM}	$(di/dt)_{cr}$	$(dv/dt)_{cr}$	V_{TM}	I_{TM} , I_{FM}	V_{TO}	r_T	t_q	V_{GT}	I_{GT}	T_{VJM}	V_{isol}	R_{thJC}
	A	A	°C	kA	A/μs	V/μs	V	A	V	mΩ	μs	V	mA	°C	V	K/W
SMTD-200	200	340	85	6.5	150	500	1.6	600	0.85	1.1	150	2.0	100	125	2500	0.125

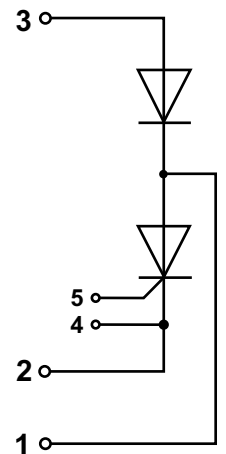
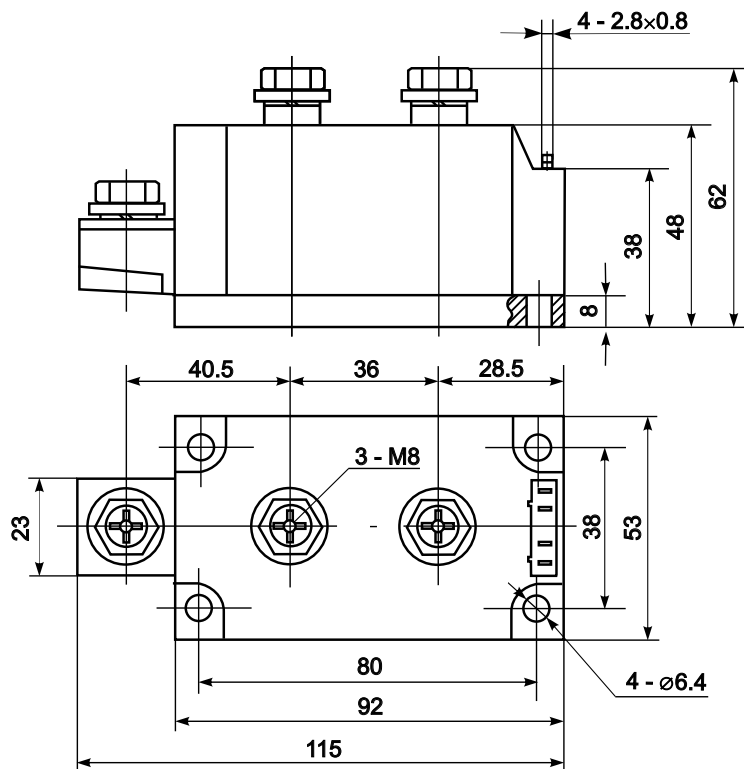

Features:

- Industrial standard package
- Heat transfer through aluminium nitride ceramic isolated metal baseplate
- Precise internal pressure contacts for high reliability
- 2500V RMS isolation voltage

Typical Applications:

- DC motor control
- AC motor soft starter
- Temperature control (e.g. for ovens, chemical processes)
- Lighting control