

SN74LS164

Serial-In Parallel-Out Shift Register

The SN74LS164 is a high speed 8-Bit Serial-In Parallel-Out Shift Register. Serial data is entered through a 2-Input AND gate synchronous with the LOW to HIGH transition of the clock. The device features an asynchronous Master Reset which clears the register setting all outputs LOW independent of the clock. It utilizes the Schottky diode clamped process to achieve high speeds and is fully compatible with all ON Semiconductor TTL products.

- Typical Shift Frequency of 35 MHz
- Asynchronous Master Reset
- Gated Serial Data Input
- Fully Synchronous Data Transfers
- Input Clamp Diodes Limit High Speed Termination Effects
- ESD > 3500 Volts

GUARANTEED OPERATING RANGES

Symbol	Parameter	Min	Typ	Max	Unit
V _{CC}	Supply Voltage	4.75	5.0	5.25	V
T _A	Operating Ambient Temperature Range	0	25	70	°C
I _{OH}	Output Current – High			-0.4	mA
I _{OL}	Output Current – Low			8.0	mA



ON Semiconductor

Formerly a Division of Motorola

<http://onsemi.com>

**LOW
POWER
SCHOTTKY**

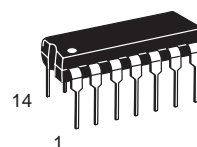

**PLASTIC
N SUFFIX
CASE 646**

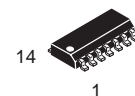

**SOIC
D SUFFIX
CASE 751A**

ORDERING INFORMATION

Device	Package	Shipping
SN74LS164N	14 Pin DIP	2000 Units/Box
SN74LS164D	14 Pin	2500/Tape & Reel

SN74LS164

CONNECTION DIAGRAM DIP (TOP VIEW)

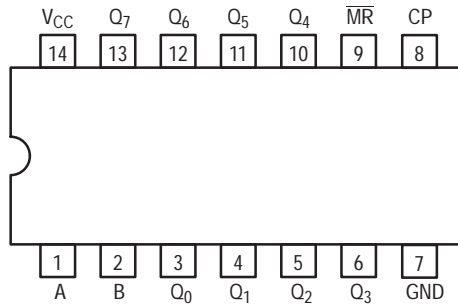

NOTE:
The Flatpak version has the same pinouts (Connection Diagram) as the Dual In-Line Package.

PIN NAMES

A, B	Data Inputs
CP	Clock (Active HIGH Going Edge) Input
\overline{MR}	Master Reset (Active LOW) Input
$Q_0 - Q_7$	Outputs

LOADING (Note a)

	HIGH	LOW
A, B	0.5 U.L.	0.25 U.L.
CP	0.5 U.L.	0.25 U.L.
\overline{MR}	0.5 U.L.	0.25 U.L.
$Q_0 - Q_7$	10 U.L.	5 U.L.

NOTES:

a) 1 TTL Unit Load (U.L.) = 40 μ A HIGH/1.6 mA LOW.

LOGIC SYMBOL

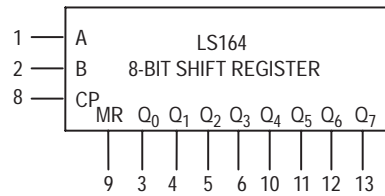

V_{CC} = PIN 14
GND = PIN 7

SN74LS164

LOGIC DIAGRAM

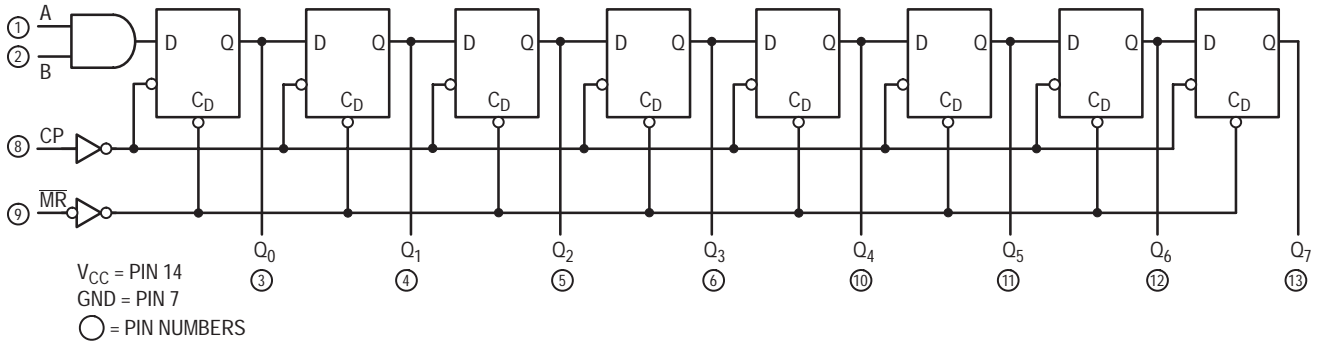

FUNCTIONAL DESCRIPTION

The LS164 is an edge-triggered 8-bit shift register with serial data entry and an output from each of the eight stages. Data is entered serially through one of two inputs (A or B); either of these inputs can be used as an active HIGH Enable for data entry through the other input. An unused input must be tied HIGH, or both inputs connected together.

Each LOW-to-HIGH transition on the Clock (CP) input shifts data one place to the right and enters into Q_0 the logical AND of the two data inputs ($A \bullet B$) that existed before the rising clock edge. A LOW level on the Master Reset (\overline{MR}) input overrides all other inputs and clears the register asynchronously, forcing all Q outputs LOW.

MODE SELECT — TRUTH TABLE

OPERATING MODE	INPUTS			OUTPUTS	
	\overline{MR}	A	B	Q_0	Q_1-Q_7
Reset (Clear)	L	X	X	L	L - L
Shift	H	l	l	L	$q_0 - q_6$
	H	l	h	L	$q_0 - q_6$
	H	h	l	L	$q_0 - q_6$
	H	h	h	H	$q_0 - q_6$

L (l) = LOW Voltage Levels

H (h) = HIGH Voltage Levels

X = Don't Care

q_n = Lower case letters indicate the state of the referenced input or output one set-up time prior to the LOW to HIGH clock transition.

SN74LS164

DC CHARACTERISTICS OVER OPERATING TEMPERATURE RANGE (unless otherwise specified)

Symbol	Parameter	Limits			Unit	Test Conditions
		Min	Typ	Max		
V _{IH}	Input HIGH Voltage	2.0			V	Guaranteed Input HIGH Voltage for All Inputs
V _{IL}	Input LOW Voltage			0.8	V	Guaranteed Input LOW Voltage for All Inputs
V _{IK}	Input Clamp Diode Voltage		-0.65	-1.5	V	V _{CC} = MIN, I _{IN} = -18 mA
V _{OH}	Output HIGH Voltage	2.7	3.5		V	V _{CC} = MIN, I _{OH} = MAX, V _{IN} = V _{IH} or V _{IL} per Truth Table
V _{OL}	Output LOW Voltage		0.25	0.4	V	I _{OL} = 4.0 mA V _{CC} = V _{CC} MIN, V _{IN} = V _{IH} or V _{IL} per Truth Table
			0.35	0.5	V	
I _{IH}	Input HIGH Current			20	μA	V _{CC} = MAX, V _{IN} = 2.7 V
				0.1	mA	V _{CC} = MAX, V _{IN} = 7.0 V
I _{IL}	Input LOW Current			-0.4	mA	V _{CC} = MAX, V _{IN} = 0.4 V
I _{OS}	Short Circuit Current (Note 1)	-20		-100	mA	V _{CC} = MAX
I _{CC}	Power Supply Current			27	mA	V _{CC} = MAX

Note 1: Not more than one output should be shorted at a time, nor for more than 1 second.

AC CHARACTERISTICS (T_A = 25°C)

Symbol	Parameter	Limits			Unit	Test Conditions
		Min	Typ	Max		
f _{MAX}	Maximum Clock Frequency	25	36		MHz	V _{CC} = 5.0 V C _L = 15 pF
t _{PHL}	Propagation Delay MR to Output Q		24	36	ns	
t _{PLH} t _{PHL}	Propagation Delay Clock to Output Q		17 21	27 32	ns	

AC SETUP REQUIREMENTS (T_A = 25°C)

Symbol	Parameter	Limits			Unit	Test Conditions
		Min	Typ	Max		
t _W	CP, MR Pulse Width	20			ns	V _{CC} = 5.0 V
t _s	Data Setup Time	15			ns	
t _h	Data Hold Time	5.0			ns	
t _{rec}	MR to Clock Recovery Time	20			ns	

SN74LS164

AC WAVEFORMS

*The shaded areas indicate when the input is permitted to change for predictable output performance.

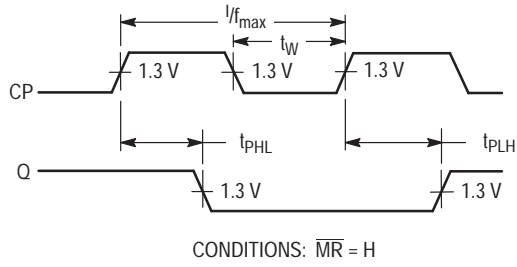

Figure 1. Clock to Output Delays and Clock Pulse Width

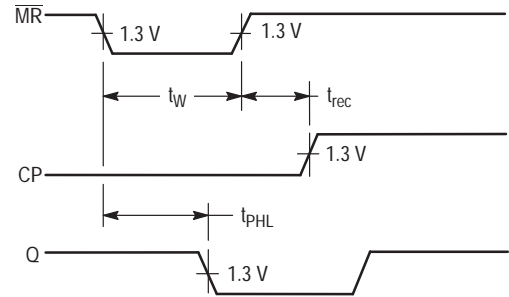

Figure 2. Master Reset Pulse Width, Master Reset to Output Delay and Master Reset to Clock Recovery Time

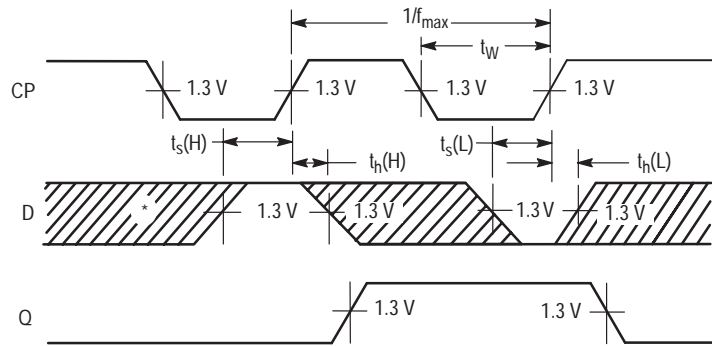
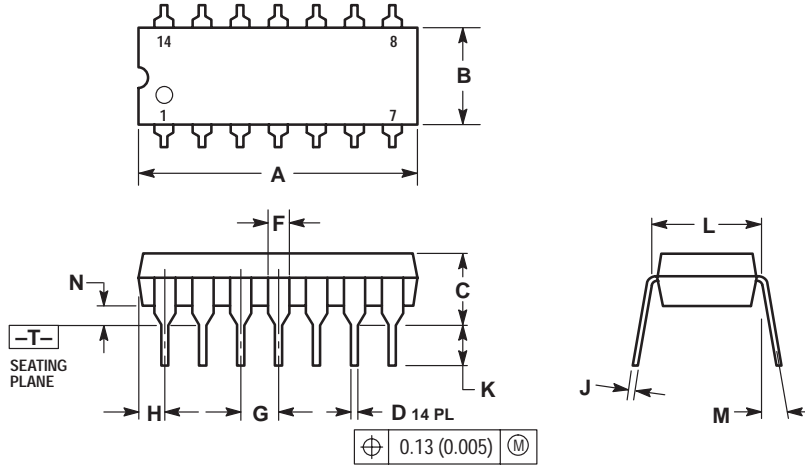

Figure 3. Data Setup and Hold Times

SN74LS164

PACKAGE DIMENSIONS

N SUFFIX
PLASTIC PACKAGE
CASE 646-06
ISSUE M



NOTES:

1. DIMENSIONING AND TOLERANCING PER ANSI Y14.5M, 1982.
2. CONTROLLING DIMENSION: INCH.
3. DIMENSION L TO CENTER OF LEADS WHEN FORMED PARALLEL.
4. DIMENSION B DOES NOT INCLUDE MOLD FLASH.
5. ROUNDED CORNERS OPTIONAL.

DIM	INCHES		MILLIMETERS	
	MIN	MAX	MIN	MAX
A	0.715	0.770	18.16	18.80
B	0.240	0.260	6.10	6.60
C	0.145	0.185	3.69	4.69
D	0.015	0.021	0.38	0.53
F	0.040	0.070	1.02	1.78
G	0.100 BSC		2.54 BSC	
H	0.052	0.095	1.32	2.41
J	0.008	0.015	0.20	0.38
K	0.115	0.135	2.92	3.43
L	0.290	0.310	7.37	7.87
M	---	10°	---	10°
N	0.015	0.039	0.38	1.01

SN74LS164

D SUFFIX PLASTIC SOIC PACKAGE CASE 751A-03 ISSUE F

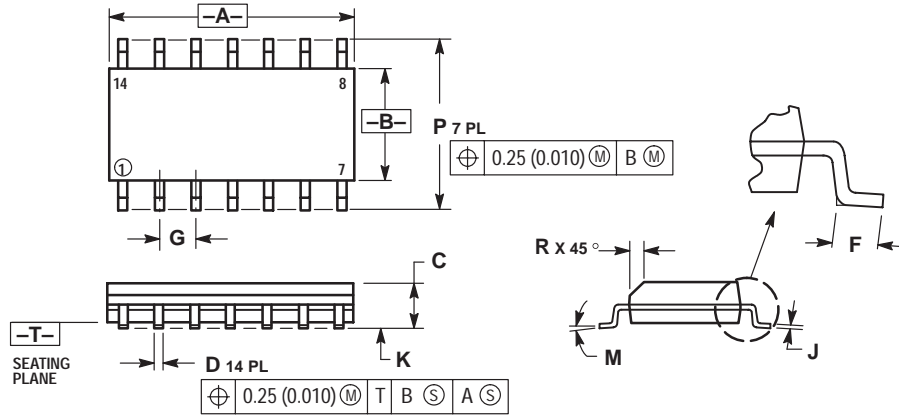

NOTES:

1. DIMENSIONING AND TOLERANCING PER ANSI Y14.5M, 1982.
2. CONTROLLING DIMENSION: MILLIMETER.
3. DIMENSIONS A AND B DO NOT INCLUDE MOLD PROTRUSION.
4. MAXIMUM MOLD PROTRUSION 0.15 (0.006) PER SIDE.
5. DIMENSION D DOES NOT INCLUDE DAMBAR PROTRUSION. ALLOWABLE DAMBAR PROTRUSION SHALL BE 0.127 (0.005) TOTAL IN EXCESS OF THE D DIMENSION AT MAXIMUM MATERIAL CONDITION.

DIM	MILLIMETERS		INCHES	
	MIN	MAX	MIN	MAX
A	8.55	8.75	0.337	0.344
B	3.80	4.00	0.150	0.157
C	1.35	1.75	0.054	0.068
D	0.35	0.49	0.014	0.019
F	0.40	1.25	0.016	0.049
G	1.27 BSC		0.050 BSC	
J	0.19	0.25	0.008	0.009
K	0.10	0.25	0.004	0.009
M	0°	7°	0°	7°
P	5.80	6.20	0.228	0.244
R	0.25	0.50	0.010	0.019

ON Semiconductor and  are trademarks of Semiconductor Components Industries, LLC (SCILLC). SCILLC reserves the right to make changes without further notice to any products herein. SCILLC makes no warranty, representation or guarantee regarding the suitability of its products for any particular purpose, nor does SCILLC assume any liability arising out of the application or use of any product or circuit, and specifically disclaims any and all liability, including without limitation special, consequential or incidental damages. "Typical" parameters which may be provided in SCILLC data sheets and/or specifications can and do vary in different applications and actual performance may vary over time. All operating parameters, including "Typicals" must be validated for each customer application by customer's technical experts. SCILLC does not convey any license under its patent rights nor the rights of others. SCILLC products are not designed, intended, or authorized for use as components in systems intended for surgical implant into the body, or other applications intended to support or sustain life, or for any other application in which the failure of the SCILLC product could create a situation where personal injury or death may occur. Should Buyer purchase or use SCILLC products for any such unintended or unauthorized application, Buyer shall indemnify and hold SCILLC and its officers, employees, subsidiaries, affiliates, and distributors harmless against all claims, costs, damages, and expenses, and reasonable attorney fees arising out of, directly or indirectly, any claim of personal injury or death associated with such unintended or unauthorized use, even if such claim alleges that SCILLC was negligent regarding the design or manufacture of the part. SCILLC is an Equal Opportunity/Affirmative Action Employer.

PUBLICATION ORDERING INFORMATION

North America Literature Fulfillment:

Literature Distribution Center for ON Semiconductor
P.O. Box 5163, Denver, Colorado 80217 USA
Phone: 303-675-2175 or 800-344-3860 Toll Free USA/Canada
Fax: 303-675-2176 or 800-344-3867 Toll Free USA/Canada
Email: ONlit@hibbertco.com

N. American Technical Support: 800-282-9855 Toll Free USA/Canada

EUROPE: LDC for ON Semiconductor – European Support

German Phone: (+1) 303-308-7140 (M-F 2:30pm to 5:00pm Munich Time)

Email: ONlit-german@hibbertco.com

French Phone: (+1) 303-308-7141 (M-F 2:30pm to 5:00pm Toulouse Time)

Email: ONlit-french@hibbertco.com

English Phone: (+1) 303-308-7142 (M-F 1:30pm to 5:00pm UK Time)

Email: ONlit@hibbertco.com

ASIA/PACIFIC: LDC for ON Semiconductor – Asia Support

Phone: 303-675-2121 (Tue-Fri 9:00am to 1:00pm, Hong Kong Time)
Toll Free from Hong Kong 800-4422-3781

Email: ONlit-asia@hibbertco.com

JAPAN: ON Semiconductor, Japan Customer Focus Center

4-32-1 Nishi-Gotanda, Shinagawa-ku, Tokyo, Japan 141-8549

Phone: 81-3-5487-8345

Email: r14153@onsemi.com

Fax Response Line: 303-675-2167

800-344-3810 Toll Free USA/Canada

ON Semiconductor Website: <http://onsemi.com>

For additional information, please contact your local
Sales Representative.