

# SN74LS193

## Presettable 4-Bit Binary Up/Down Counter

The SN74LS193 is an UP/DOWN MODULO-16 Binary Counter. Separate Count Up and Count Down Clocks are used and the circuits can operate synchronously. The outputs change state synchronous with the LOW-to-HIGH transitions on the clock inputs.

Separate Terminal Count Up and Terminal Count Down outputs are provided which are used as the clocks for a subsequent stages without extra logic, thus simplifying multistage counter designs. Individual preset inputs allow the circuits to be used as programmable counters. Both the Parallel Load ( $\overline{PL}$ ) and the Master Reset (MR) inputs asynchronously override the clocks.

- Low Power . . . 95 mW Typical Dissipation
- High Speed . . . 40 MHz Typical Count Frequency
- Synchronous Counting
- Asynchronous Master Reset and Parallel Load
- Individual Preset Inputs
- Cascading Circuitry Internally Provided
- Input Clamp Diodes Limit High Speed Termination Effects

### GUARANTEED OPERATING RANGES

Symbol	Parameter	Min	Typ	Max	Unit
$V_{CC}$	Supply Voltage	4.75	5.0	5.25	V
$T_A$	Operating Ambient Temperature Range	0	25	70	°C
$I_{OH}$	Output Current – High			-0.4	mA
$I_{OL}$	Output Current – Low			8.0	mA



**ON Semiconductor**  
Formerly a Division of Motorola  
<http://onsemi.com>

**LOW  
POWER  
SCHOTTKY**

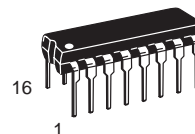

**PLASTIC  
N SUFFIX  
CASE 648**

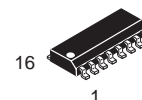

**SOIC  
D SUFFIX  
CASE 751B**

### ORDERING INFORMATION

Device	Package	Shipping
SN74LS193N	16 Pin DIP	2000 Units/Box
SN74LS193D	16 Pin	2500/Tape & Reel

# SN74LS193

## CONNECTION DIAGRAM DIP (TOP VIEW)

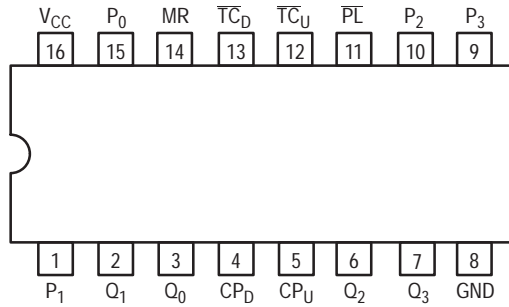

NOTE:  
The Flatpak version has the same pinouts (Connection Diagram) as the Dual In-Line Package.

### PIN NAMES

CP <sub>U</sub>	Count Up Clock Pulse Input
CP <sub>D</sub>	Count Down Clock Pulse Input
MR	Asynchronous Master Reset (Clear) Input
PL	Asynchronous Parallel Load (Active LOW) Input
P <sub>n</sub>	Parallel Data Inputs
Q <sub>n</sub>	Flip-Flop Outputs
TC <sub>D</sub>	Terminal Count Down (Borrow) Output
TC <sub>U</sub>	Terminal Count Up (Carry) Output

### LOADING (Note a)

	HIGH	LOW
CP <sub>U</sub>	0.5 U.L.	0.25 U.L.
CP <sub>D</sub>	0.5 U.L.	0.25 U.L.
MR	0.5 U.L.	0.25 U.L.
PL	0.5 U.L.	0.25 U.L.
P <sub>n</sub>	0.5 U.L.	0.25 U.L.
Q <sub>n</sub>	10 U.L.	5 U.L.
TC <sub>D</sub>	10 U.L.	5 U.L.
TC <sub>U</sub>	10 U.L.	5 U.L.

### NOTES:

a) 1 TTL Unit Load (U.L.) = 40 μA HIGH/1.6 mA LOW.

### LOGIC SYMBOL

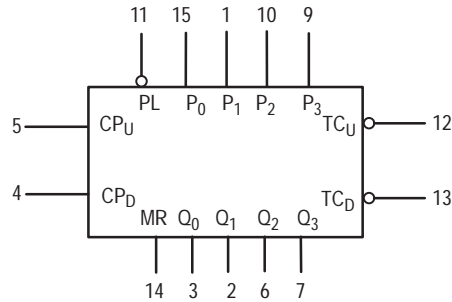

V<sub>CC</sub> = PIN 16  
GND = PIN 8

# SN74LS193

## STATE DIAGRAM

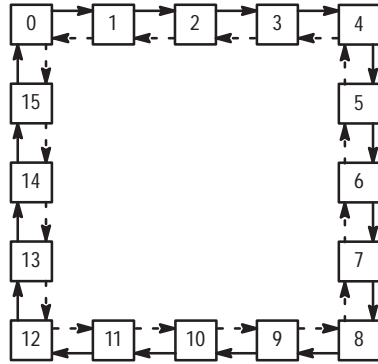

### LOGIC EQUATIONS FOR TERMINAL COUNT

$$\overline{TC}_U = Q_0 \cdot Q_1 \cdot Q_2 \cdot Q_3 \cdot \overline{CP}_U$$

$$\overline{TC}_D = Q_0 \cdot Q_1 \cdot Q_2 \cdot Q_3 \cdot CP_D$$

COUNT UP ———  
 COUNT DOWN - - - -

## LOGIC DIAGRAM

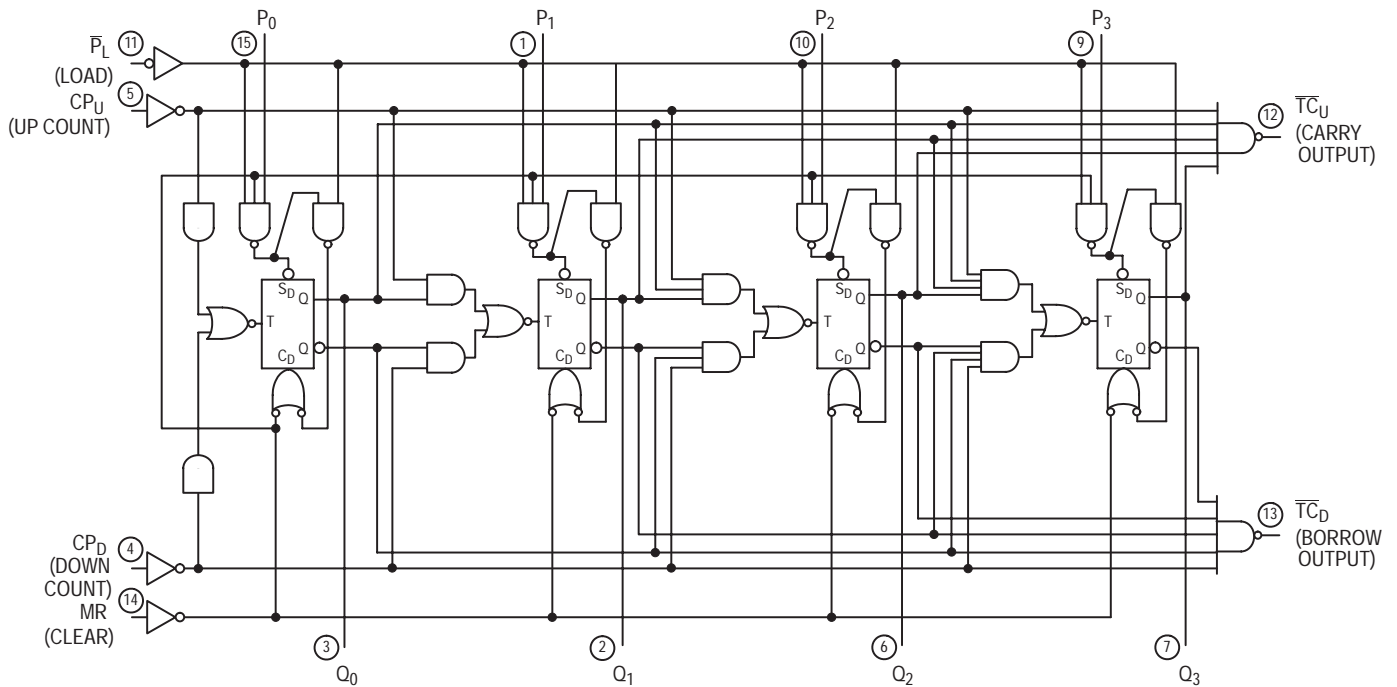

$V_{CC}$  = PIN 16  
 GND = PIN 8  
 ○ = PIN NUMBERS

# SN74LS193

## FUNCTIONAL DESCRIPTION

The LS193 is a 4-Bit Binary Synchronous UP/DOWN (Reversible) Counter. Each circuit contains four master/slave flip-flops, with internal gating and steering logic to provide master reset, individual preset, count up and count down operations.

Each flip-flop contains JK feedback from slave to master such that a LOW-to-HIGH transition on its T input causes the slave, and thus the Q output to change state. Synchronous switching, as opposed to ripple counting, is achieved by driving the steering gates of all stages from a common Count Up line and a common Count Down line, thereby causing all state changes to be initiated simultaneously. A LOW-to-HIGH transition on the Count Up input will advance the count by one; a similar transition on the Count Down input will decrease the count by one. While counting with one clock input, the other should be held HIGH. Otherwise, the circuit will either count by twos or not at all, depending on the state of the first flip-flop, which cannot toggle as long as either Clock input is LOW.

The Terminal Count Up ( $\overline{TC}_U$ ) and Terminal Count Down ( $\overline{TC}_D$ ) outputs are normally HIGH. When a circuit has

reached the maximum count state of 15, the next HIGH-to-LOW transition of the Count Up Clock will cause  $\overline{TC}_U$  to go LOW.  $\overline{TC}_U$  will stay LOW until  $CP_U$  goes HIGH again, thus effectively repeating the Count Up Clock, but delayed by two gate delays. Similarly, the  $\overline{TC}_D$  output will go LOW when the circuit is in the zero state and the Count Down Clock goes LOW. Since the TC outputs repeat the clock waveforms, they can be used as the clock input signals to the next higher order circuit in a multistage counter.

Each circuit has an asynchronous parallel load capability permitting the counter to be preset. When the Parallel Load ( $\overline{PL}$ ) and the Master Reset (MR) inputs are LOW, information present on the Parallel Data inputs ( $P_0, P_3$ ) is loaded into the counter and appears on the outputs regardless of the conditions of the clock inputs. A HIGH signal on the Master Reset input will disable the preset gates, override both Clock inputs, and latch each Q output in the LOW state. If one of the Clock inputs is LOW during and after a reset or load operation, the next LOW-to-HIGH transition of that Clock will be interpreted as a legitimate signal and will be counted.

**MODE SELECT TABLE**

MR	$\overline{PL}$	$CP_U$	$CP_D$	MODE
H	X	X	X	Reset (Asyn.)
L	L	X	X	Preset (Asyn.)
L	H	H	H	No Change
L	H	$\uparrow$	H	Count Up
L	H	H	$\downarrow$	Count Down

L = LOW Voltage Level  
H = HIGH Voltage Level  
X = Don't Care  
 $\uparrow$  = LOW-to-HIGH Clock Transition

# SN74LS193

## DC CHARACTERISTICS OVER OPERATING TEMPERATURE RANGE (unless otherwise specified)

Symbol	Parameter	Limits			Unit	Test Conditions
		Min	Typ	Max		
V <sub>IH</sub>	Input HIGH Voltage	2.0			V	Guaranteed Input HIGH Voltage for All Inputs
V <sub>IL</sub>	Input LOW Voltage			0.8	V	Guaranteed Input LOW Voltage for All Inputs
V <sub>IK</sub>	Input Clamp Diode Voltage		-0.65	-1.5	V	V <sub>CC</sub> = MIN, I <sub>IN</sub> = -18 mA
V <sub>OH</sub>	Output HIGH Voltage	2.7	3.5		V	V <sub>CC</sub> = MIN, I <sub>OH</sub> = MAX, V <sub>IN</sub> = V <sub>IH</sub> or V <sub>IL</sub> per Truth Table
V <sub>OL</sub>	Output LOW Voltage		0.25	0.4	V	I <sub>OL</sub> = 4.0 mA V <sub>CC</sub> = V <sub>CC</sub> MIN, V <sub>IN</sub> = V <sub>IL</sub> or V <sub>IH</sub> per Truth Table
			0.35	0.5	V	
I <sub>IH</sub>	Input HIGH Current			20	μA	V <sub>CC</sub> = MAX, V <sub>IN</sub> = 2.7 V
				0.1	mA	V <sub>CC</sub> = MAX, V <sub>IN</sub> = 7.0 V
I <sub>IL</sub>	Input LOW Current			-0.4	mA	V <sub>CC</sub> = MAX, V <sub>IN</sub> = 0.4 V
I <sub>OS</sub>	Short Circuit Current (Note 1)	-20		-100	mA	V <sub>CC</sub> = MAX
I <sub>CC</sub>	Power Supply Current			34	mA	V <sub>CC</sub> = MAX

Note 1: Not more than one output should be shorted at a time, nor for more than 1 second.

## AC CHARACTERISTICS (T<sub>A</sub> = 25°C)

Symbol	Parameter	Limits			Unit	Test Conditions
		Min	Typ	Max		
f <sub>MAX</sub>	Maximum Clock Frequency	25	32		MHz	V <sub>CC</sub> = 5.0 V C <sub>L</sub> = 15 pF
t <sub>PLH</sub> t <sub>PHL</sub>	CP <sub>U</sub> Input to TC <sub>U</sub> Output		17 18	26 24	ns	
t <sub>PLH</sub> t <sub>PHL</sub>	CP <sub>D</sub> Input to TC <sub>D</sub> Output		16 15	24 24	ns	
t <sub>PLH</sub> t <sub>PHL</sub>	Clock to Q		27 30	38 47	ns	
t <sub>PLH</sub> t <sub>PHL</sub>	$\overline{PL}$ to Q		24 25	40 40	ns	
t <sub>PHL</sub>	MR Input to Any Output		23	35	ns	

## AC SETUP REQUIREMENTS (T<sub>A</sub> = 25°C)

Symbol	Parameter	Limits			Unit	Test Conditions
		Min	Typ	Max		
t <sub>W</sub>	Any Pulse Width	20			ns	V <sub>CC</sub> = 5.0 V
t <sub>s</sub>	Data Setup Time	20			ns	
t <sub>h</sub>	Data Hold Time	5.0			ns	
t <sub>rec</sub>	Recovery Time	40			ns	

## DEFINITIONS OF TERMS

SETUP TIME (t<sub>s</sub>) is defined as the minimum time required for the correct logic level to be present at the logic input prior to the  $\overline{PL}$  transition from LOW-to-HIGH in order to be recognized and transferred to the outputs.

HOLD TIME (t<sub>h</sub>) is defined as the minimum time following the  $\overline{PL}$  transition from LOW-to-HIGH that the logic level must be maintained at the input in order to ensure continued

recognition. A negative HOLD TIME indicates that the correct logic level may be released prior to the  $\overline{PL}$  transition from LOW-to-HIGH and still be recognized.

RECOVERY TIME (t<sub>rec</sub>) is defined as the minimum time required between the end of the reset pulse and the clock transition from LOW-to-HIGH in order to recognize and transfer HIGH data to the Q outputs.

# SN74LS193

## AC WAVEFORMS

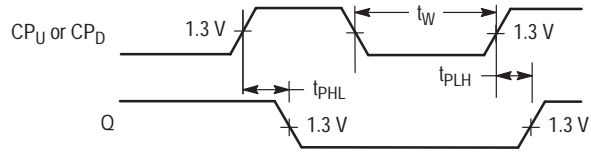

Figure 1.

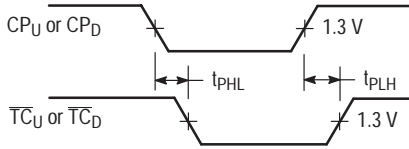
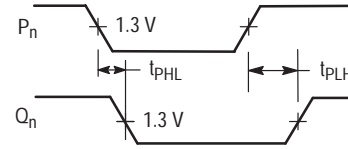

Figure 2.



NOTE: PL = LOW

Figure 3.

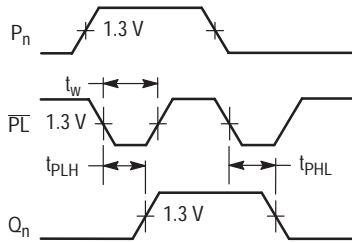

Figure 4.

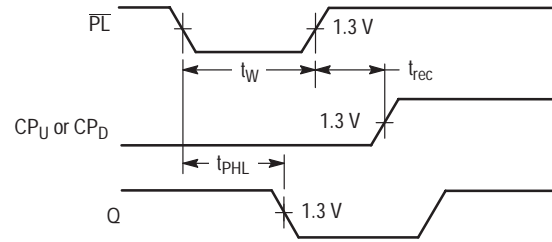
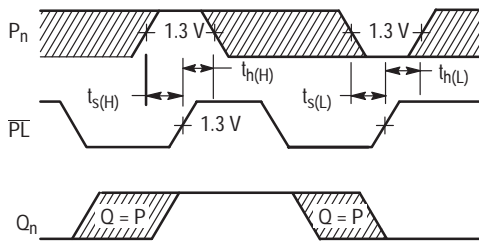

Figure 5.



\* The shaded areas indicate when the input is permitted to change for predictable output performance

Figure 6.

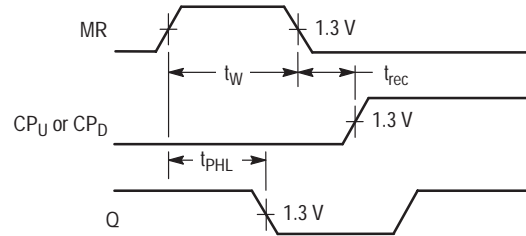
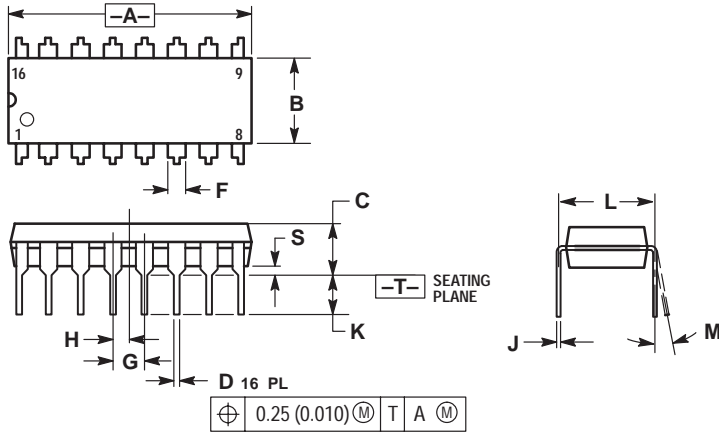

Figure 7.

# SN74LS193

## PACKAGE DIMENSIONS

### N SUFFIX PLASTIC PACKAGE CASE 648-08 ISSUE R



NOTES:

1. DIMENSIONING AND TOLERANCING PER ANSI Y14.5M, 1982.
2. CONTROLLING DIMENSION: INCH.
3. DIMENSION L TO CENTER OF LEADS WHEN FORMED PARALLEL.
4. DIMENSION B DOES NOT INCLUDE MOLD FLASH.
5. ROUNDED CORNERS OPTIONAL.

DIM	INCHES		MILLIMETERS	
	MIN	MAX	MIN	MAX
A	0.740	0.770	18.80	19.55
B	0.250	0.270	6.35	6.85
C	0.145	0.175	3.69	4.44
D	0.015	0.021	0.39	0.53
F	0.040	0.70	1.02	1.77
G	0.100 BSC		2.54 BSC	
H	0.050 BSC		1.27 BSC	
J	0.008	0.015	0.21	0.38
K	0.110	0.130	2.80	3.30
L	0.295	0.305	7.50	7.74
M	0°	10°	0°	10°
S	0.020	0.040	0.51	1.01

### D SUFFIX PLASTIC SOIC PACKAGE CASE 751B-05 ISSUE J

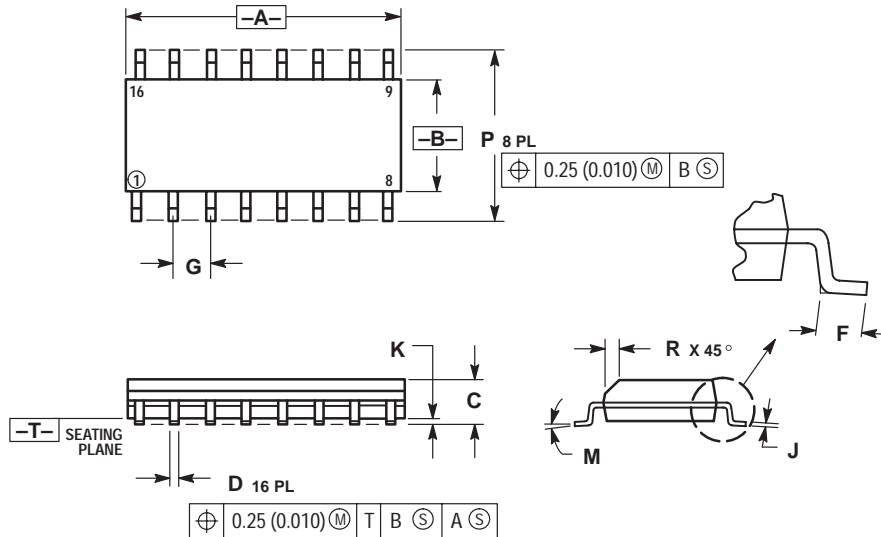

NOTES:

1. DIMENSIONING AND TOLERANCING PER ANSI Y14.5M, 1982.
2. CONTROLLING DIMENSION: MILLIMETER.
3. DIMENSIONS A AND B DO NOT INCLUDE MOLD PROTRUSION.
4. MAXIMUM MOLD PROTRUSION 0.15 (0.006) PER SIDE.
5. DIMENSION D DOES NOT INCLUDE DAMBAR PROTRUSION. ALLOWABLE DAMBAR PROTRUSION SHALL BE 0.127 (0.005) TOTAL IN EXCESS OF THE D DIMENSION AT MAXIMUM MATERIAL CONDITION.

DIM	MILLIMETERS		INCHES	
	MIN	MAX	MIN	MAX
A	9.80	10.00	0.386	0.393
B	3.80	4.00	0.150	0.157
C	1.35	1.75	0.054	0.068
D	0.35	0.49	0.014	0.019
F	0.40	1.25	0.016	0.049
G	1.27 BSC		0.050 BSC	
J	0.19	0.25	0.008	0.009
K	0.10	0.25	0.004	0.009
M	0°	7°	0°	7°
P	5.80	6.20	0.229	0.244
R	0.25	0.50	0.010	0.019

**ON Semiconductor** and  are trademarks of Semiconductor Components Industries, LLC (SCILLC). SCILLC reserves the right to make changes without further notice to any products herein. SCILLC makes no warranty, representation or guarantee regarding the suitability of its products for any particular purpose, nor does SCILLC assume any liability arising out of the application or use of any product or circuit, and specifically disclaims any and all liability, including without limitation special, consequential or incidental damages. "Typical" parameters which may be provided in SCILLC data sheets and/or specifications can and do vary in different applications and actual performance may vary over time. All operating parameters, including "Typicals" must be validated for each customer application by customer's technical experts. SCILLC does not convey any license under its patent rights nor the rights of others. SCILLC products are not designed, intended, or authorized for use as components in systems intended for surgical implant into the body, or other applications intended to support or sustain life, or for any other application in which the failure of the SCILLC product could create a situation where personal injury or death may occur. Should Buyer purchase or use SCILLC products for any such unintended or unauthorized application, Buyer shall indemnify and hold SCILLC and its officers, employees, subsidiaries, affiliates, and distributors harmless against all claims, costs, damages, and expenses, and reasonable attorney fees arising out of, directly or indirectly, any claim of personal injury or death associated with such unintended or unauthorized use, even if such claim alleges that SCILLC was negligent regarding the design or manufacture of the part. SCILLC is an Equal Opportunity/Affirmative Action Employer.

## PUBLICATION ORDERING INFORMATION

### North America Literature Fulfillment:

Literature Distribution Center for ON Semiconductor  
P.O. Box 5163, Denver, Colorado 80217 USA  
**Phone:** 303-675-2175 or 800-344-3860 Toll Free USA/Canada  
**Fax:** 303-675-2176 or 800-344-3867 Toll Free USA/Canada  
**Email:** ONlit@hibbertco.com

**N. American Technical Support:** 800-282-9855 Toll Free USA/Canada

**EUROPE:** LDC for ON Semiconductor – European Support

**German Phone:** (+1) 303-308-7140 (M-F 2:30pm to 5:00pm Munich Time)  
**Email:** ONlit-german@hibbertco.com  
**French Phone:** (+1) 303-308-7141 (M-F 2:30pm to 5:00pm Toulouse Time)  
**Email:** ONlit-french@hibbertco.com  
**English Phone:** (+1) 303-308-7142 (M-F 1:30pm to 5:00pm UK Time)  
**Email:** ONlit@hibbertco.com

**ASIA/PACIFIC:** LDC for ON Semiconductor – Asia Support

**Phone:** 303-675-2121 (Tue-Fri 9:00am to 1:00pm, Hong Kong Time)  
Toll Free from Hong Kong 800-4422-3781  
**Email:** ONlit-asia@hibbertco.com

**JAPAN:** ON Semiconductor, Japan Customer Focus Center  
4-32-1 Nishi-Gotanda, Shinagawa-ku, Tokyo, Japan 141-8549

**Phone:** 81-3-5487-8345  
**Email:** r14153@onsemi.com

**Fax Response Line:** 303-675-2167  
800-344-3810 Toll Free USA/Canada

**ON Semiconductor Website:** <http://onsemi.com>

For additional information, please contact your local  
Sales Representative.