



8-BIT ADDRESSABLE LATCH

The SN54/74LS259 is a high-speed 8-Bit Addressable Latch designed for general purpose storage applications in digital systems. It is a multifunctional device capable of storing single line data in eight addressable latches, and also a 1-of-8 decoder and demultiplexer with active HIGH outputs. The device also incorporates an active LOW common Clear for resetting all latches, as well as, an active LOW Enable.

- Serial-to-Parallel Conversion
- Eight Bits of Storage With Output of Each Bit Available
- Random (Addressable) Data Entry
- Active High Demultiplexing or Decoding Capability
- Easily Expandable
- Common Clear

CONNECTION DIAGRAM DIP (TOP VIEW)

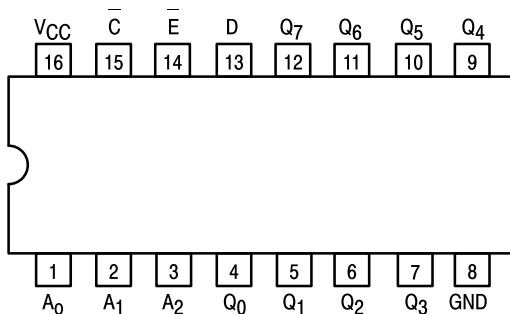

PIN NAMES

A ₀ , A ₁ , A ₂	Address Inputs
<u>D</u>	Data Input
<u>E</u>	Enable (Active LOW) Input
<u>C</u>	Clear (Active LOW) input
Q ₀ to Q ₇	Parallel Latch Outputs (Note b)

LOADING (Note a)

	HIGH	LOW
A ₀ , A ₁ , A ₂	0.5 U.L.	0.25 U.L.
<u>D</u>	0.5 U.L.	0.25 U.L.
<u>E</u>	1.0 U.L.	0.5 U.L.
<u>C</u>	0.5 U.L.	0.25 U.L.
Q ₀ to Q ₇	10 U.L.	5 (2.5) U.L.

NOTES:

- a) 1 TTL Unit Load (U.L.) = 40 μA HIGH/1.6 mA LOW.
 b) The Output LOW drive factor is 2.5 U.L. for Military (54) and 5 U.L. for Commercial (74) Temperature Ranges.

GUARANTEED OPERATING RANGES

Symbol	Parameter		Min	Typ	Max	Unit
V _{CC}	Supply Voltage	54 74	4.5 4.75	5.0 5.0	5.5 5.25	V
T _A	Operating Ambient Temperature Range	54 74	-55 0	25 25	125 70	°C
I _{OH}	Output Current — High	54, 74			-0.4	mA
I _{OL}	Output Current — Low	54 74			4.0 8.0	mA

SN54/74LS259

8-BIT ADDRESSABLE LATCH LOW POWER SCHOTTKY

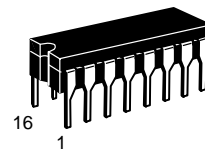

J SUFFIX
CERAMIC
CASE 620-09

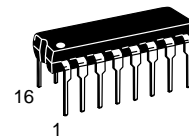

N SUFFIX
PLASTIC
CASE 648-08

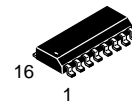

D SUFFIX
SOIC
CASE 751B-03

ORDERING INFORMATION

SN54LSXXXJ	Ceramic
SN74LSXXXN	Plastic
SN74LSXXXD	SOIC

SN54/74LS259

LOGIC DIAGRAM

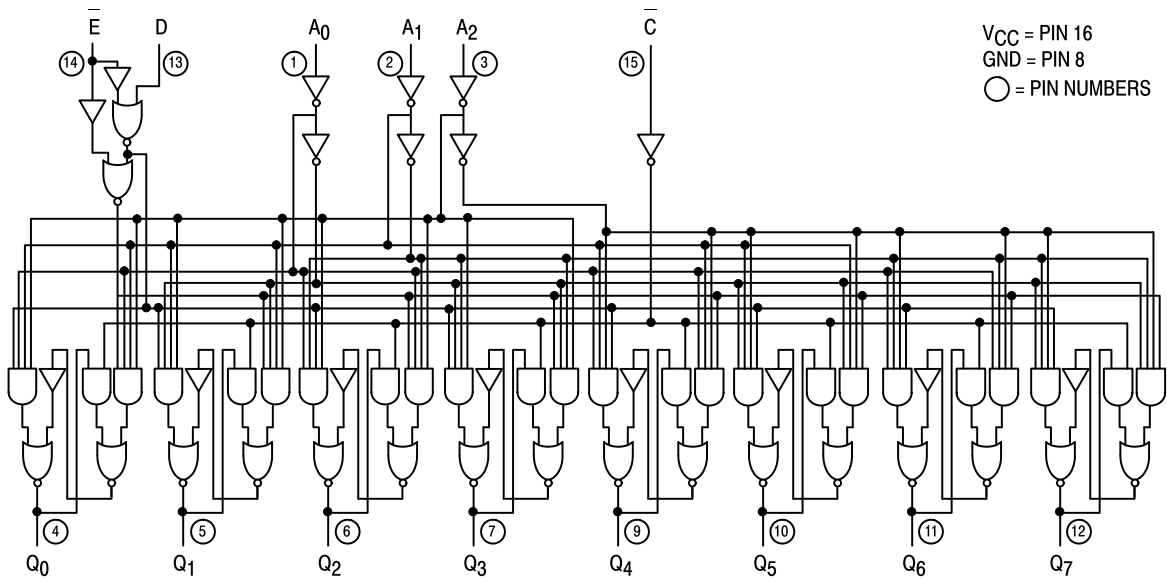

V_{CC} = PIN 16
 GND = PIN 8
 ○ = PIN NUMBERS

FUNCTIONAL DESCRIPTION

The SN54/74LS259 has four modes of operation as shown in the mode selection table. In the addressable latch mode, data on the Data line (D) is written into the addressed latch. The addressed latch will follow the data input with all non-addressed latches remaining in their previous states. In the memory mode, all latches remain in their previous state and are unaffected by the Data or Address inputs.

In the one-of-eight decoding or demultiplexing mode, the

addressed output will follow the state of the D input with all other inputs in the LOW state. In the clear mode all outputs are LOW and unaffected by the address and data inputs.

When operating the SN54/74LS259 as an addressable latch, changing more than one bit of the address could impose a transient wrong address. Therefore, this should only be done while in the memory mode.

The truth table below summarizes the operations.

MODE SELECTION

E	C	MODE
L	H	Addressable Latch
H	H	Memory
L	L	Active HIGH Eight-Channel Demultiplexer
H	L	Clear

TRUTH TABLE

PRESENT OUTPUT STATES

C	E	D	A ₀	A ₁	A ₂	Q ₀	Q ₁	Q ₂	Q ₃	Q ₄	Q ₅	Q ₆	Q ₇	MODE
L	H	X	X	X	X	L	L	L	L	L	L	L	L	Clear Demultiplex
L	L	H	L	L	L	H	L	L	L	L	L	L	L	
L	L	L	H	L	L	L	L	L	L	L	L	L	L	Memory
L	L	H	H	L	L	L	H	L	L	L	L	L	L	
•	•	•	•	•	•	•	•	•	•	•	•	•	•	
•	•	•	•	•	•	•	•	•	•	•	•	•	•	
•	•	•	•	•	•	•	•	•	•	•	•	•	•	
•	•	•	•	•	•	•	•	•	•	•	•	•	•	
•	•	•	•	•	•	•	•	•	•	•	•	•	•	
•	•	•	•	•	•	•	•	•	•	•	•	•	•	
L	L	H	H	H	H	L	L	L	L	L	L	L	H	
H	H	X	X	X	X	Q _{N-1}	→						Memory	
H	L	L	L	L	L	L	Q _{N-1}	Q _{N-1}	Q _{N-1}	Q _{N-1}	→			Addressable Latch
H	L	H	L	L	L	H	Q _{N-1}	Q _{N-1}	Q _{N-1}	Q _{N-1}	→			
H	L	L	H	L	L	Q _{N-1}	L	Q _{N-1}	Q _{N-1}	Q _{N-1}	→			
H	L	H	H	L	L	Q _{N-1}	H	Q _{N-1}	Q _{N-1}	Q _{N-1}	→			
•	•	•	•	•	•	•	•	•	•	•	•	•	•	Addressable Latch
•	•	•	•	•	•	•	•	•	•	•	•	•	•	
•	•	•	•	•	•	•	•	•	•	•	•	•	•	
•	•	•	•	•	•	•	•	•	•	•	•	•	•	
•	•	•	•	•	•	•	•	•	•	•	•	•	•	
•	•	•	•	•	•	•	•	•	•	•	•	•	•	
H	L	L	H	H	H	Q _{N-1}	→						Q _{N-1} L	
H	L	H	H	H	H	Q _{N-1}	→						Q _{N-1} H	

X = Don't Care Condition
 L = LOW Voltage Level
 H = HIGH Voltage Level
 Q_{N-1} = Previous Output State

SN54/74LS259

DC CHARACTERISTICS OVER OPERATING TEMPERATURE RANGE (unless otherwise specified)

Symbol	Parameter		Limits			Unit	Test Conditions
			Min	Typ	Max		
V _{IH}	Input HIGH Voltage		2.0			V	Guaranteed Input HIGH Voltage for All Inputs
V _{IL}	Input LOW Voltage	54			0.7	V	Guaranteed Input LOW Voltage for All Inputs
		74			0.8		
V _{IK}	Input Clamp Diode Voltage			-0.65	-1.5	V	V _{CC} = MIN, I _{IN} = -18 mA
V _{OH}	Output HIGH Voltage	54	2.5	3.5		V	V _{CC} = MIN, I _{OH} = MAX, V _{IN} = V _{IH} or V _{IL} per Truth Table
		74	2.7	3.5		V	
V _{OL}	Output LOW Voltage	54, 74		0.25	0.4	V	I _{OL} = 4.0 mA V _{CC} = V _{CC} MIN, V _{IN} = V _{IL} or V _{IH} per Truth Table
		74		0.35	0.5	V	
I _{IH}	Input HIGH Current				20	μA	V _{CC} = MAX, V _{IN} = 2.7 V
					0.1	mA	V _{CC} = MAX, V _{IN} = 7.0 V
I _{IL}	Input LOW Current				-0.4	mA	V _{CC} = MAX, V _{IN} = 0.4 V
I _{OS}	Short Circuit Current (Note 1)		-20		-100	mA	V _{CC} = MAX
I _{CC}	Power Supply Current				36	mA	V _{CC} = MAX

Note 1: Not more than one output should be shorted at a time, nor for more than 1 second.

AC CHARACTERISTICS (T_A = 25°C, V_{CC} = 5.0 V)

Symbol	Parameter		Limits			Unit	Test Conditions
			Min	Typ	Max		
t _{PLH}	Turn-Off Delay, Enable to Output			22	35	ns	C _L = 15 pF
t _{PHL}	Turn-On Delay, Enable to Output			15	24	ns	
t _{PLH}	Turn-Off Delay, Data to Output			20	32	ns	
t _{PHL}	Turn-On Delay, Data to Output			13	21	ns	
t _{PLH}	Turn-Off Delay, Address to Output			24	38	ns	
t _{PHL}	Turn-On Delay, Address to Output			18	29	ns	
t _{PHL}	Turn-On Delay, Clear to Output			17	27	ns	

AC SET-UP REQUIREMENTS (T_A = 25°C, V_{CC} = 5.0 V)

Symbol	Parameter		Limits			Unit
			Min	Typ	Max	
t _s	Input Setup Time		20			ns
t _w	Pulse Width, Clear or Enable		15			ns
t _h	Hold Time, Data		5.0			ns
t _h	Hold Time, Address		20			ns

SN54/74LS259

AC WAVEFORMS

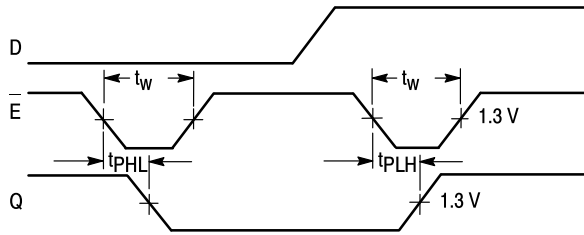

OTHER CONDITIONS: $\bar{C} = H, A = \text{STABLE}$

Figure 1. Turn-on and Turn-off Delays, Enable To Output and Enable Pulse Width

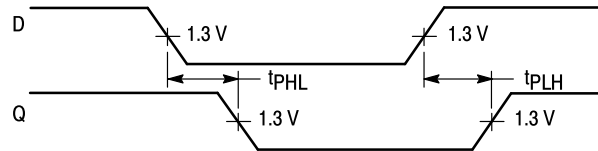

OTHER CONDITIONS: $\bar{E} = L, \bar{C} = H, A = \text{STABLE}$

Figure 2. Turn-on and Turn-off Delays, Data to Output

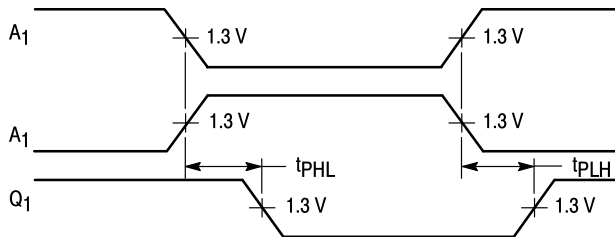

OTHER CONDITIONS: $\bar{E} = L, \bar{C} = L, D = H$

Figure 3. Turn-on and Turn-off Delays, Address to Output

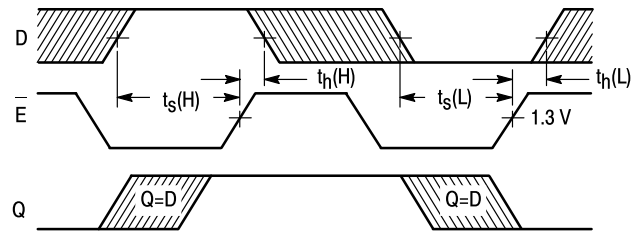

OTHER CONDITIONS: $\bar{C} = H, A = \text{STABLE}$

Figure 4. Setup and Hold Time, Data to Enable

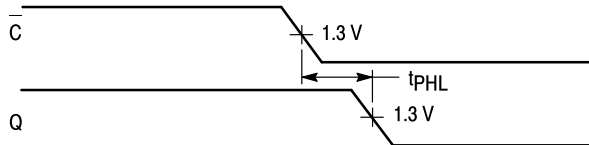

OTHER CONDITIONS: $\bar{E} = H$

Figure 5. Turn-on Delay, Clear to Output

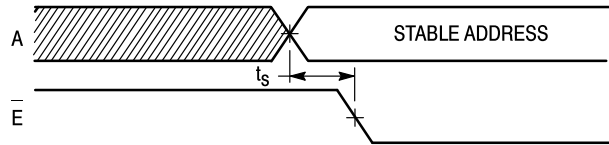

OTHER CONDITIONS: $\bar{C} = H$

Figure 6. Setup Time, Address to Enable (See Notes 1 and 2)

NOTES:

1. The Address to Enable Setup Time is the time before the HIGH-to-LOW Enable transition that the Address must be stable so that the correct latch is addressed and the other latches are not affected.
2. The shaded areas indicate when the inputs are permitted to change for predictable output performance.

**Case 751B-03 D Suffix
16-Pin Plastic
SO-16**



- NOTES:
1. DIMENSIONING AND TOLERANCING PER ANSI Y14.5M, 1982.
 2. CONTROLLING DIMENSION: MILLIMETER.
 3. DIMENSION A AND B DO NOT INCLUDE MOLD PROTRUSION.
 4. MAXIMUM MOLD PROTRUSION 0.15 (0.006) PER SIDE.
 5. 751B-01 IS OBSOLETE, NEW STANDARD 751B-03.

DIM	MILLIMETERS		INCHES	
	MIN	MAX	MIN	MAX
A	9.80	10.00	0.386	0.393
B	3.80	4.00	0.150	0.157
C	1.35	1.75	0.054	0.068
D	0.35	0.49	0.014	0.019
F	0.40	1.25	0.016	0.049
G	1.27 BSC		0.050 BSC	
J	0.19	0.25	0.008	0.009
K	0.10	0.25	0.004	0.009
M	0°	7°	0°	7°
P	5.80	6.20	0.229	0.244
R	0.25	0.50	0.010	0.019

**Case 648-08 N Suffix
16-Pin Plastic**



- NOTES:
1. DIMENSIONING AND TOLERANCING PER ANSI Y14.5M, 1982.
 2. CONTROLLING DIMENSION: INCH.
 3. DIMENSION "L" TO CENTER OF LEADS WHEN FORMED PARALLEL.
 4. DIMENSION "B" DOES NOT INCLUDE MOLD FLASH.
 5. ROUNDED CORNERS OPTIONAL.
 6. 648-01 THRU -07 OBSOLETE, NEW STANDARD 648-08.

DIM	MILLIMETERS		INCHES	
	MIN	MAX	MIN	MAX
A	18.80	19.55	0.740	0.770
B	6.35	6.85	0.250	0.270
C	3.69	4.44	0.145	0.175
D	0.39	0.53	0.015	0.021
F	1.02	1.77	0.040	0.070
G	2.54 BSC		0.100 BSC	
H	1.27 BSC		0.050 BSC	
J	0.21	0.38	0.008	0.015
K	2.80	3.30	0.110	0.130
L	7.50	7.74	0.295	0.305
M	0°	10°	0°	10°
S	0.51	1.01	0.020	0.040

**Case 620-09 J Suffix
16-Pin Ceramic Dual In-Line**



- NOTES:
1. DIMENSIONING AND TOLERANCING PER ANSI Y14.5M, 1982.
 2. CONTROLLING DIMENSION: INCH.
 3. DIMENSION L TO CENTER OF LEAD WHEN FORMED PARALLEL.
 4. DIM F MAY NARROW TO 0.76 (0.030) WHERE THE LEAD ENTERS THE CERAMIC BODY.
 5. 620-01 THRU -08 OBSOLETE, NEW STANDARD 620-09.

DIM	MILLIMETERS		INCHES	
	MIN	MAX	MIN	MAX
A	19.05	19.55	0.750	0.770
B	6.10	7.36	0.240	0.290
C	—	4.19	—	0.165
D	0.39	0.53	0.015	0.021
E	1.27 BSC		0.050 BSC	
F	1.40	1.77	0.055	0.070
G	2.54 BSC		0.100 BSC	
J	0.23	0.27	0.009	0.011
K	—	5.08	—	0.200
L	7.62 BSC		0.300 BSC	
M	0°	15°	0°	15°
N	0.39	0.88	0.015	0.035

Motorola reserves the right to make changes without further notice to any products herein. Motorola makes no warranty, representation or guarantee regarding the suitability of its products for any particular purpose, nor does Motorola assume any liability arising out of the application or use of any product or circuit, and specifically disclaims any and all liability, including without limitation consequential or incidental damages. "Typical" parameters can and do vary in different applications. All operating parameters, including "Typicals" must be validated for each customer application by customer's technical experts. Motorola does not convey any license under its patent rights nor the rights of others. Motorola products are not designed, intended, or authorized for use as components in systems intended for surgical implant into the body, or other applications intended to support or sustain life, or for any other application in which the failure of the Motorola product could create a situation where personal injury or death may occur. Should Buyer purchase or use Motorola products for any such unintended or unauthorized application, Buyer shall indemnify and hold Motorola and its officers, employees, subsidiaries, affiliates, and distributors harmless against all claims, costs, damages, and expenses, and reasonable attorney fees arising out of, directly or indirectly, any claim of personal injury or death associated with such unintended or unauthorized use, even if such claim alleges that Motorola was negligent regarding the design or manufacture of the part. Motorola and  are registered trademarks of Motorola, Inc. Motorola, Inc. is an Equal Opportunity/Affirmative Action Employer.

Literature Distribution Centers:

USA: Motorola Literature Distribution; P.O. Box 20912; Phoenix, Arizona 85036.

EUROPE: Motorola Ltd.; European Literature Centre; 88 Tanners Drive, Blakelands, Milton Keynes, MK14 5BP, England.

JAPAN: Nippon Motorola Ltd.; 4-32-1, Nishi-Gotanda, Shinagawa-ku, Tokyo 141, Japan.

ASIA PACIFIC: Motorola Semiconductors H.K. Ltd.; Silicon Harbour Center, No. 2 Dai King Street, Tai Po Industrial Estate, Tai Po, N.T., Hong Kong.

