

RoHS Compliant Product

A suffix of "-C" specifies halogen & lead-free

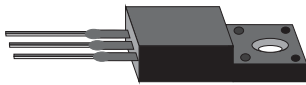

ITO-220

FEATURES

- * Low forward voltage drop
- * High current capability
- * High reliability
- * High surge current capability
- * Epitaxial construction

MECHANICAL DATA

- * Case: Molded plastic
- * Epoxy: UL 94V-0 rate flame retardant
- * Lead: Lead solderable per MIL-STD-202, method 208 guaranteed
- * Polarity: As Marked
- * Mounting position: Any
- * Weight: 2.24 grams

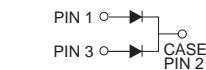
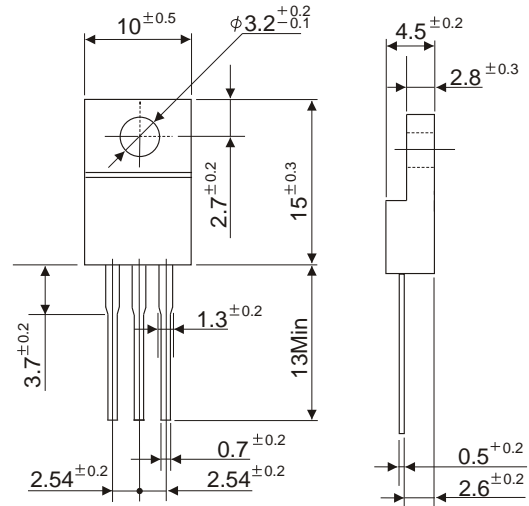

Dimensions in millimeters

MAXIMUM RATINGS AND ELECTRICAL CHARACTERISTICS

Rating 25°C ambient temperature unless otherwise specified.
Single phase half wave, 60Hz, resistive or inductive load.
For capacitive load, derate current by 20%.

TYPE NUMBER	SP3020R	SP3030R	SP3040R	SP3060R	SP3080R	SP30100R	UNITS	
Maximum Recurrent Peak Reverse Voltage	20	30	40	60	80	100	V	
Working Peak Reverse Voltage	20	30	40	60	80	100	V	
Maximum DC Blocking Voltage	20	30	40	60	80	100	V	
Maximum Average Forward Rectified Current See Fig. 1	30						A	
Peak Forward Surge Current, 8.3 ms single half sine-wave superimposed on rated load (JEDEC method)	280			230			A	
Maximum Instantaneous Forward Voltage at 15.0A Ta=25°C	0.52		0.65		0.80		V	
Maximum DC Reverse Current Ta=25°C	0.15						mA	
at Rated DC Blocking Voltage Ta=100°C	100						mA	
Typical Junction Capacitance (Note 1)	700			460		280		pF
Typical Thermal Resistance RθJC (Note 2)	3.5						°C/W	
Operating Temperature Range Tj	-50 ~ +150						°C	
Storage Temperature Range Tstg	-65 ~ +175						°C	

NOTES:

1. Measured at 1MHz and applied reverse voltage of 4.0V D.C.
2. Thermal Resistance Junction to Case.

RATING AND CHARACTERISTIC CURVES (SP3020R THRU SP30100R)

FIG.1-TYPICAL FORWARD CURRENT DERATING CURVE

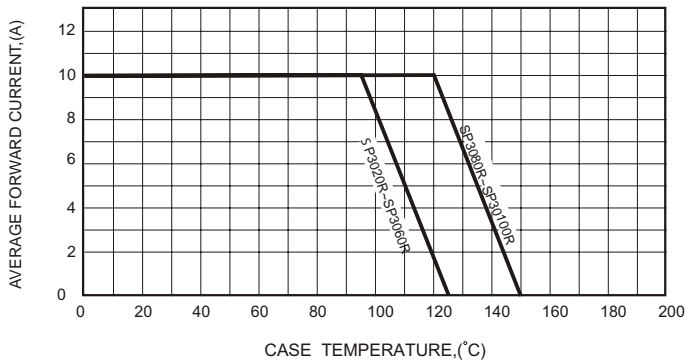

FIG.2-TYPICAL FORWARD CHARACTERISTICS

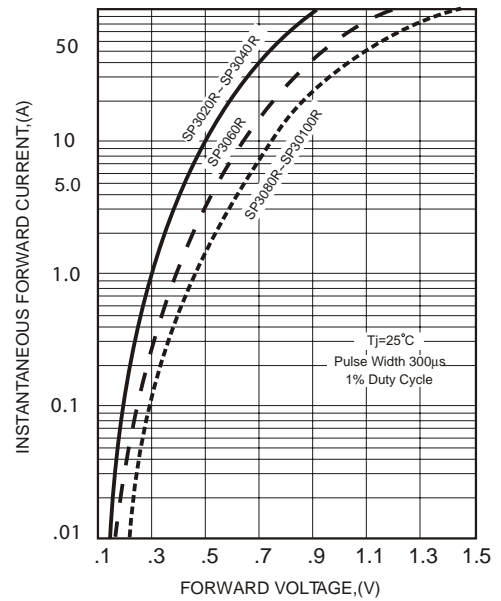

FIG.3-MAXIMUM NON-REPETITIVE FORWARD SURGE CURRENT

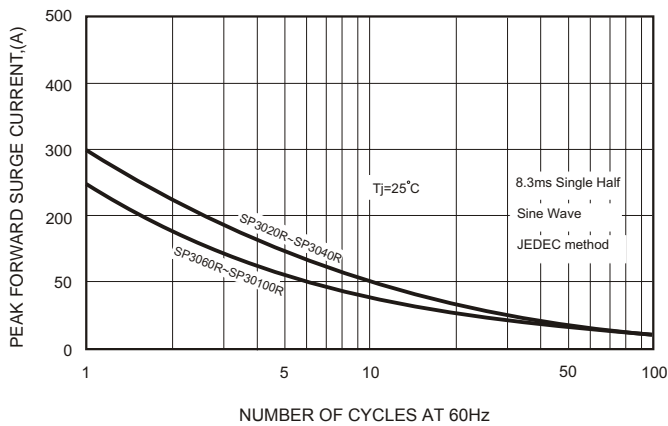

FIG.5 - TYPICAL REVERSE CHARACTERISTICS

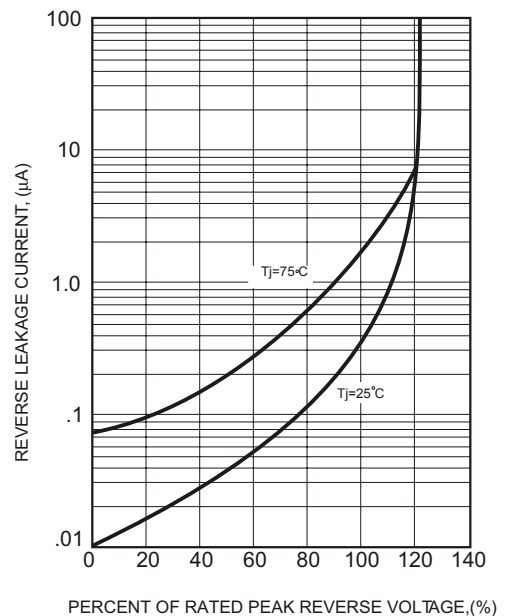

FIG.4-TYPICAL JUNCTION CAPACITANCE

